



InstruTech[®], Inc.

**Cold Cathode Ionization Vacuum Gauge
CCM500 Module
*The Hornet™***



User Manual

InstruTech, Inc.
1475 S. Fordham St.
Longmont, CO 80503
USA

Phone: +1-303-651-0551
Fax: +1-303-678-1754
E-mail info@instrutechinc.com
www.instrutechinc.com

Important User Information There are operational characteristic differences between solid state equipment and electromechanical equipment. Because of these differences, and because there are a variety of uses for solid state equipment, all persons that apply this equipment must take every precaution and satisfy themselves that the intended application of this equipment is safe and used in an acceptable manner.

In no event will InstruTech, Inc. be responsible or liable for indirect or consequential damages that result from the use or application of this equipment.

Any examples or diagrams included in this manual are provided solely for illustrative purposes. Because of the many variables and requirements imposed on any particular installation, InstruTech, Inc. cannot assume responsibility or liability for any actual use based on the examples and diagrams.

No patent liability is assumed by InstruTech, Inc. with respect to use of information circuits, equipment, or software described in this manual.

Throughout this manual we use notes, notices and apply internationally recognized symbols and safety messages to make you aware of safety considerations.

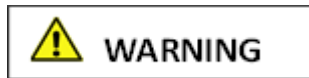

Identifies information about practices or circumstances that can cause electrical or physical hazards which, if precautions are not taken, could result in death or serious injury, property damage, or economic loss.



Identifies information about practices or circumstances that can cause electrical or physical hazards which, if precautions are not taken, could result in minor or moderate injury, property damage, or economic loss.



Identifies information that is critical for successful application and understanding of the product.



Labels may be located on or inside the device to alert people that dangerous voltages may be present.

Copyright © 2012 by InstruTech, Inc.

All rights reserved. No part of this work may be reproduced or transmitted in any form or by any means, electronic or mechanical, including photocopying and recording, or by any information storage or retrieval system, except as may be expressly permitted in writing by InstruTech, Inc.

Printed in the United States of America

Conflat® is a registered trademark of Varian, Inc. / Agilent Technologies, Lexington, MA

Table of Contents

1	Introduction / General Information	3
1.1	Description	3
1.2	Specifications	3
1.3	Dimensions.....	4
1.4	Part Numbers	4
2	Important Safety Information.....	5
2.1	Safety Precautions - General.....	5
2.2	Safety Precautions - Service and operation.....	6
2.3	Electrical Conditions.....	7
2.3.1	Proper Equipment Grounding	7
2.3.2	Electrical Interface and Control	7
2.4	Overpressure and use with hazardous gases	7
2.5	Gases other than Nitrogen / air	8
3	Installation	9
3.1	Mechanical Installation	9
3.2	Electrical Installation.....	9
3.2.1	Grounding	9
3.2.2	Connector	10
4	Bakeout	11
5	Setup and Operation.....	12
5.1	Overpressure shut down.....	12
5.2	Activating the sensor	12
5.3	Gauge Status LED	13
6	Using the gauge with different gases	13

7 Service14

 7.1 Calibration14

 7.2 Troubleshooting - Operation14

 7.3 Maintenance15

 7.4 Contamination15

 7.5 Cold Cathode Sensor Replacement.....16

 7.6 Cold Cathode Sensor Cleaning17

8 Factory Service and Support18

9 Warranty18

1 Introduction / General Information

1.1 Description

A cold cathode ionization gauge measures vacuum pressure by first ionizing gas molecules inside the vacuum gauge and then measuring the resulting ion current. A large potential between the sensor anode and cathode will cause ionization to occur. The amount of ion current generated from the ionized gas is proportional to the pressure in the vacuum system and is dependent on the type of gas used. As the pressure inside the vacuum system drops, the measured ion current drops. The design of InstruTech’s cold cathode transducer includes an internal O-ring which will allow easy disassembly for cleaning.

The InstruTech® CCM500 Hornet™ module is an ionization gauge module specifically designed for use with InstruTech’s B-RAX -3200 and FlexRax® 4000 vacuum gauge controllers. The measurement range for the CCM500 cold cathode ionization gauge is 1.00×10^{-9} to 1.00×10^{-2} Torr.

1.2 Specifications

measurement range	1×10^{-9} to 1×10^{-2} Torr / 1.3×10^{-9} to 1.3×10^{-2} mbar / 1.3×10^{-7} Pa to 1.3 Pa	
accuracy - N ₂ (typical)	1×10^{-8} to 1×10^{-2} Torr; ± 30% of reading	
repeatability (typical)	± 5% of reading	
materials exposed to gases	304 stainless steel, ceramic, Viton® O-ring	
sensitivity	factory preset to 10 Torr ⁻¹ . Also user adjustable from 2 to 99 (set by B-RAX or FlexRax)	
overpressure protection	gauge turns off at factory default setting of 1×10^{-2} Torr	
internal gauge volume	1.965 in ³ (32.2 cm ³)	
operating temperature	0 °C to + 40 °C	
storage temperature	-40 to +70 °C	
bakeout temperature	150 °C (sensor only - electronics removed), limit to 5 hours with magnets installed	
humidity	0 to 95% relative humidity, non-condensing	
weight	1.7 lb. (0.77 kg) with NW25 KF flange	
housing (electronics)	aluminum extrusion	
mounting orientation	any	
altitude	operating	8,200 ft. (2,500 m) max.
	storage	41,000 ft. (12,500 m) max.
analog output	analog output is available at the B-RAX 3200 or FlexRax	
setpoint relay	relays available at the B-RAX or FlexRax	
status outputs	anode (sensor) on/off status is determined by LED on the CCM500 and also display messages and available user interface options on the B-RAX or FlexRax	
input control signal	all CCM500 operations controlled from the B-RAX or FlexRax	
input power	powered by either the B-RAX or FlexRax controller	
connector/cabling	InstruTech cable/connector assembly for connection to either B-RAX or FlexRax	
CE compliance	EMC Directive 2004/108/EC, EN61326-1, EN55011 Low Voltage Directive 2006/95/EC, EN61010-1	
environmental	RoHS compliant	

1.3 Dimensions

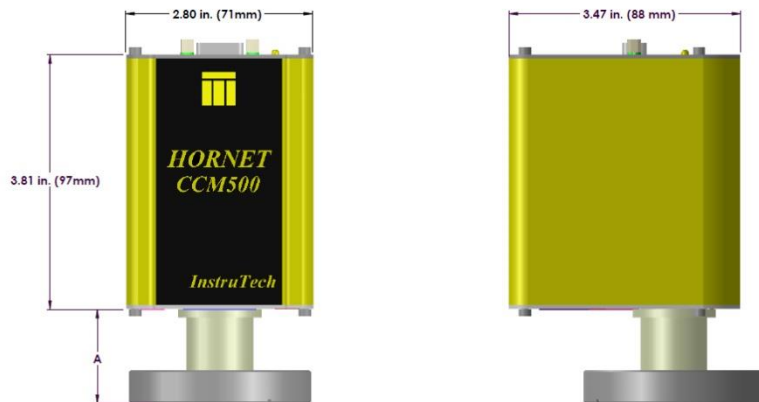

fitting	dimension A
1 in. Tube	2.56 in. (65 mm)
NW16KF	2.63 in. (67 mm)
NW25KF	2.63 in. (67 mm)
NW40KF	2.82 in. (72 mm)
1 1/3 in. Mini-CF	2.11 in. (54 mm)
2 3/4 in. Conflat®	2.63 in. (67 mm)

1.4 Part Numbers

CCM500 Fittings / Flanges	Cold Cathode Module	Replacement Sensor
1 in. Tube (1 in. O.D. O-ring compression)	CCM500TX	CC5T
NW16KF	CCM500BX	CC5B
NW25KF	CCM500CX	CC5C
NW40KF	CCM500DX	CC5D
1 1/3 in. Mini-CF/NW16CF Mini-Conflat®	CCM500EX	CC5E
2 3/4 in. CF / NW35CF Conflat®	CCM500FX	CC5F

CCM500 / B-RAX, FlexRax cable	Part Number
Cable, CCM500 to B-RAX/FlexRax, 10ft. (3m)	BXC400-1-10F ¹
Cable, CCM500 to B-RAX/FlexRax, 25ft. (8m)	BXC400-1-25F
Cable, CCM500 to B-RAX/FlexRax, 50ft. (15m)	BXC400-1-50F

¹ BXC400-1- type cables are compatible with both CCM500 and IGM400 Hornet devices.

2 Important Safety Information

InstruTech has designed and tested this product to provide safe and reliable service, provided it is installed and operated within the *strict safety guidelines provided in this manual*. **Please read and follow all warnings and instructions.**



To avoid serious injury or death, follow the safety information in this document. Failure to comply with these safety procedures could result in serious bodily harm, including death, and or property damage.

Failure to comply with these warnings violates the safety standards of installation and intended use of this instrument. InstruTech, Inc. disclaims all liability for the customer's failure to comply with these instructions.

Although every attempt has been made to consider most possible installations, InstruTech cannot anticipate every contingency that arises from various installations, operation, or maintenance of the module. If you have any questions about the safe installation and use of this product, please contact InstruTech.

This device meets FCC part 15 requirements for an unintentional radiator, class A.

2.1 Safety Precautions - General

Hazardous voltages are present with this product during normal operation. The product should never be operated with the covers removed unless equivalent protection of the operator from accidental contact with hazardous internal voltages is provided.

 **WARNING!** There are no operator serviceable parts or adjustments inside the product enclosure; refer servicing to service trained personnel.

Do not modify this product or substitute any parts without authorization of qualified InstruTech service trained personnel. Return the product to an InstruTech qualified service and repair center to ensure that all safety features are maintained. Do not use this product if unauthorized modifications have been made.

 **WARNING!** Source power must be removed from the product prior to performing any servicing.

After servicing this product, ensure that all safety checks are made by a qualified service person. When replacement parts are required, ensure that the parts are specified by InstruTech, Inc. Substitutions of non-qualified parts may result in fire, electric shock or other hazards. Use of unauthorized parts or modifications made to this product will void the warranty.

To reduce the risk of fire or electric shock, do not expose this product to rain or moisture. These products are not waterproof and careful attention must be paid to not spill any type of liquid onto these products. Do not use these products if they have been damaged. Immediately contact InstruTech, Inc. to arrange return of the product if it is damaged.

Due to the possibility of corrosion when used in certain environmental conditions, it is possible that the product's safety could be compromised over time. It is important that the product be periodically inspected for sound electrical connections and equipment grounding. Do not use if the equipment grounding or electrical insulation has been compromised.

2.2 Safety Precautions - Service and operation

Ensure the CCM500 is properly connected to earth ground.

Do not turn on the anode voltage and try to activate the sensor when pressure exceeds 1.00×10^{-2} Torr.

 **WARNING!** The power supply used in the Cold Cathode Gauge Module (CCM500) is subject to high voltages which could cause severe injury or death. In order to prevent electric shock and bodily harm, the user should wait at least 1 minute after power is removed before touching the CCM500 power supply components.

 **WARNING!** When the anode voltage is turned on and the sensor activated, 3,900 Vdc is present at the power supply and other components. **DO NOT** operate the CCM500 with the CCM500 enclosure removed. Contact with exposed electrical circuits in the CCM500 could result in death or serious injury.

Turn off power to the unit before attempting to service the module. Switch either the B-RAX or FlexRax controller AC Mains Power Inlet switch to OFF and disconnect the control cable from the CCM500.

Turn off power to the unit before detaching the electronics from the sensor for sensor replacement, sensor cleaning or bake-out purposes. The source power to the CCM500 is provided via the cable connecting the module to the B-RAX or FlexRax controller.

Turn off power to the unit if a cable or plug is damaged or the product is not operating normally according to this instruction manual. Contact qualified InstruTech service personnel for any service or troubleshooting condition that may not be covered by this instruction manual.

Do not use if the unit has been dropped or the enclosure has been damaged. Contact InstruTech for return authorization and instructions for returning the product to InstruTech for evaluation.

The most common cause of all vacuum gauge failures is contamination of the sensor. Noisy, abnormally low, or erratic readings and total gauge failure are possible indications of gauge contamination. Contamination can generally be characterized as either:

- A) A physical or chemical reaction of process gases with the sensor elements. If such is the case, the sensor material is most likely not compatible with your application and a different gauge may be required.
- B) An accumulation of material on the sensor element. In this case, sensor cleaning may resolve the issue. Refer to the [section 7.6](#) titled "Cold Cathode Sensor Cleaning" for detailed cleaning procedure.

2.3 Electrical Conditions

 **WARNING!** When high voltage is present in any vacuum system, a life threatening electrical shock hazard may exist unless all exposed electrical conductors are maintained at earth ground potential. This applies to all products that come in contact with the gas contained in vacuum chambers. An electrical discharge within a gaseous environment may couple dangerous high voltage directly to any ungrounded conductor of electricity. A person could be seriously injured or killed by coming in contact with an exposed, ungrounded electrical conductor at high voltage potential. This condition applies to all products that may come in contact with the gas inside the vacuum chamber (vacuum/pressure containment vessel).

2.3.1 Proper Equipment Grounding

 **WARNING!** Hazardous voltages that could seriously injure or cause death are present in many vacuum processes. Verify that the vacuum connection port on which the ion gauge is mounted is electrically grounded. Consult a qualified Electrician if you are in doubt about your equipment grounding. Proper grounding of your equipment is essential for safety as well as intended operation of the equipment. The vacuum gauge transducer and enclosure of any control module must be connected directly to a good quality equipment earthing conductor. Use a ground lug on the vacuum connection flange of the pressure measurement device if necessary.

 **WARNING!** In order to protect personnel from electric shock and bodily harm, shield all conductors which are subject to potential high voltage electrical discharges in or around the vacuum system.

2.3.2 Electrical Interface and Control

It is the user's responsibility to ensure that the electrical signals from this product and any connections made to external devices, for example, relays and solenoids, are used in a safe manner. Always double check the system set-up before using any signals to automate your process. Perform a hazardous operation analysis of your system design and ensure safeguards and personnel safety measures are taken to prevent injury and property damage.

2.4 Overpressure and use with hazardous gases

 **WARNING!** Install suitable protective devices that will limit the level of pressure inside your vacuum chamber to less than what the vacuum chamber system components are capable of withstanding. The InstruTech CCM500 gauge should not be used at pressures exceeding 7000 Torr absolute pressure. Failure to provide adequate overpressure protection may result in bodily injury and possible equipment damage due to forcible release of component parts or explosion of the pressurized vessel.

In cases where an equipment failure could cause a hazardous condition, always implement fail-safe system operation. For example, use a pressure relief device in an automatic backfill operation where a malfunction could result in high internal pressures if the pressure relief device was not installed on the chamber. **DO NOT** exceed pressures above 135 psia (7000 Torr, 9 bars) inside the sensor. If your chamber, vacuum vessel or

connecting pipe goes to higher pressures, you should install an isolation valve or pressure relief device to protect the gauge tube from overpressure conditions. With some fittings, actual safe overpressure conditions may be lower; for example, a quick-connect, O-ring compression fitting may forcibly release the gauge tube from the vacuum chamber fitting with only a few psi over local uncorrected barometric (atmospheric) pressure.

⚠ CAUTION! If the internal pressure of a vacuum gauge device is allowed to increase above local uncorrected barometric pressure (atmospheric pressure side), vacuum fittings may release and possible overpressure conditions may cause leaks that would allow the gas inside the gauge tube to release into the atmosphere of the surrounding environment. Toxic, pyrophoric and flammable gases are examples of hazardous gases that if allowed to leak out of the vacuum/pressure containment vessel into the atmospheric environment, could cause bodily injury and possible damage to equipment. Never expose the gauge tube internal volume to pressure above local atmospheric pressure when using hazardous gases.

2.5 *Gases other than Nitrogen / air*

⚠ WARNING! Do not attempt to use with gases other than nitrogen (N₂) or air without referring to correction factor data tables.

InstruTech gauges and modules are calibrated for direct readout of nitrogen or air. Do not attempt to use with other gases such as argon (Ar) or carbon dioxide (CO₂), unless you have programmed the device for the appropriate gas or use accurate conversion data for N₂ to other gases. Refer to [section 6](#) titled “Using the gauge with different gases” for a more complete discussion.

3 Installation

3.1 Mechanical Installation

Mount the CCM500 as close as possible to the pressure you want to measure. Long or restricted, small diameter tubing will create a pressure difference between your process chamber and the gauge. This may cause a delay in response to pressure changes. Mounting the CCM500 too close to a gas source inlet may also cause measurement and control instability.

The CCM500 can be mounted in any orientation, however, if possible, mount the gauge with port down to help minimize the effect of any particles or condensation collecting in the gauge.

Do not mount the CCM500 where it will be subjected to excessive vibration. Vibrations may cause unstable readings, measurement errors and possible mechanical stress to components in the CCM500.

Shield the CCM500 near ion or electron sources such as an electron beam or in a sputtering system.

For electrical safety purposes the housing of the gauge must be grounded to the vacuum chamber. When using KF flanges, metal clamps must be used to ensure proper grounding. Do not attempt to modify your flange in order to use non-metallic-type flange clamps.

Fittings/Flanges - follow the fitting/flange manufacturer's recommendations for installation and use.

To ensure a good high or ultra-high vacuum (UHV) compatible connection, use all metal vacuum fittings with metal seals when operating pressures are expected to be at or below 1.00×10^{-7} Torr (1.33×10^{-7} mbar or 1.33×10^{-5} Pa).

3.2 Electrical Installation

3.2.1 Grounding

 Be sure the vacuum gauge and the rest of your vacuum system are properly grounded to protect personnel from shock and injury. Be aware that some vacuum fittings, especially those with O-rings when not used with metal clamps, may not produce a good electrical connection between the gauge and the chamber it is connected to. Use a ground lug on the vacuum connection flange of the pressure measurement device if necessary.

3.2.2 Connector

Good, recommended practice is to remove power from any cable prior to connecting or disconnecting it. Use the cable/connector assembly provided by InstruTech for connection to either the B-RAX or FlexRax vacuum gauge controller. The programming parameters for the CCM500 module are transmitted between the module and the B-RAX or FlexRax immediately during initial AC Mains Power ON condition. If a CCM500 module is swapped or a cable from one module is moved and reconnected to a different module, the controller unit considers the first module connected at power ON to be the device it is communicating with.

Changing cables from one device to another when power is applied to the module is not only bad electronics handling procedure, it is not advised and, if done by the user of this equipment, may lead to erroneous measurement results, a hazardous situation, equipment damage and possible operator injury .

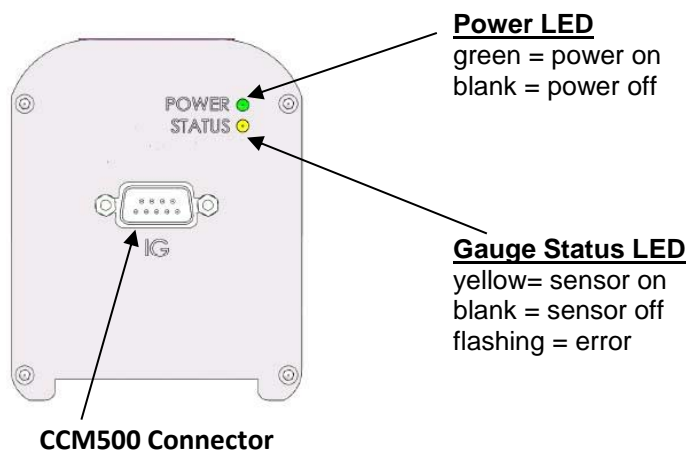

⚠ CAUTION! Possible damage to property and injury to personnel may result if connections to the Ion Gauge (IG) connector of the CCM500 are made while power is applied to the controller unit. **DO NOT** connect, disconnect or reconnect the cable from the controller back panel IG connector to the CCM500 module when power is applied to the controller. Switch the AC Mains Power Switch on the back panel of either the B-RAX or FlexRax controller to OFF (0) prior to either disconnecting or reconnecting cables to the CCM500 module.

The DE-9P D-subminiature end of the InstruTech cable assembly for connecting the CCM500 ion gauge module to either the B-RAX or FlexRax is connected to the CCM500 module. The mini-DIN connector end of this cable connects to the connector labeled **IG** on the back panel of the B-RAX or FlexRax.

4 Bakeout

If desired, a chamber bakeout may be performed for new systems or after routine maintenance. The sensor can be baked out to 150 °C, but the bakeout duration should not exceed 5 hours to prevent possible damage to magnets. Ensure the temperature of the sensor tube and the vacuum fitting to the sensor is at the same or above the chamber temperature during the bakeout procedure. The electronic control module must be removed from the cold cathode sensor if the bakeout temperature is to exceed 70 °C. To bakeout the cold cathode sensor perform the following procedure:

1. Turn off power to the CCM500.
2. Disconnect the cable from the CCM500.
3. Use a 3/32 in. size Hex key to remove the #4-40 socket head cap screws (SHCS) as shown below.
4. Detach the electronics from the sensor by sliding the metal electronics enclosure away from the sensor. Pull the electronics enclosure with a continuous straight line motion away from sensor.
5. Perform bake out with the electronics removed. The bakeout duration should not exceed 5 hours to prevent damage to magnets.
6. Prior to reattaching the electronics, make sure the arrow on the magnet assembly is aligned with engraved line on anode assembly.
7. Reattach the electronics enclosure. Reinstall the 4-40 SHCS (4 ea).

Bakeout

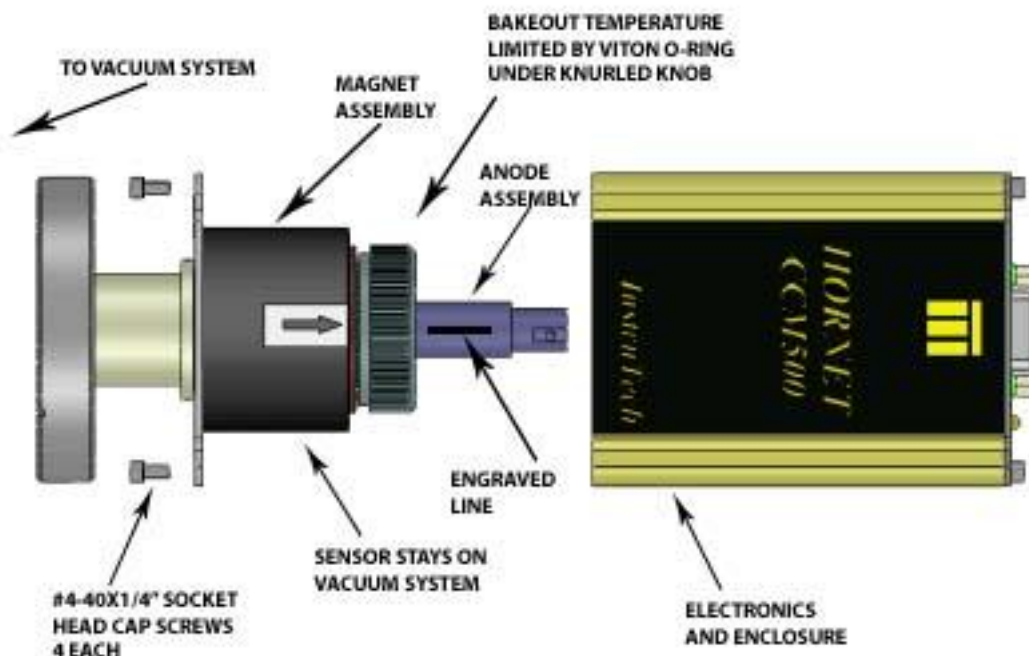

5 Setup and Operation

The CCM500 receives operating power from the B-RAX or FlexRax controller via a custom cable supplied by InstruTech. All display and control functions of the CCM500 are performed remotely by the B-RAX or FlexRax controller. The CCM500 receives commands from the B-RAX or FlexRax controller for the control of the ion gauge power supply and all other control functions. Read this user manual in its entirety before activating the sensor. Refer to [section 5.6](#) titled “Activating the sensor” for further details.

5.1 Overpressure shut down

The CCM500 is provided with factory set default values for overpressure shut down. The gauge sensor will shut off automatically should the pressure reach or rise above the pressure shut down values shown below:

Factory set overpressure shut down values

Overpressure Shut Down (Torr)	Overpressure Shut Down (mbar)	Overpressure Shut Down (Pa)
1.00×10^{-2}	1.33×10^{-2}	1.33

5.2 Activating the sensor

Before you turn on the anode voltage and activate the sensor, make sure you understand all instructions and information provided in this manual and the User Manual for the controller.

You can activate the sensor by one of the following methods:

- 1) Manually turn the IG on or off using the B-RAX or FlexRax front panel controls - see controller User Manual for procedure.
- 2) Use another gauge such as a convection gauge to automatically turn the IG ON/OFF at a pressure programmed using the B-RAX or FlexRax controllers - see controller User Manual for procedure.

The cold cathode gauge will exhibit some level of activation time delay when the sensor is being activated at pressures below $1.0\text{E-}5$ Torr. This is the time needed for the electrical discharge to establish itself at low pressures. A rough estimate for this time delay can be determined by the following equation:

$$T, \text{ seconds} = 1/\text{pressure in } \mu\text{Torr}$$

Example: If the pressure at which the gauge is being activated is $1.00\text{E-}07$ Torr ($1.00\text{E-}07 \times 1,000,000 = 0.1 \mu\text{Torr}$), then $T = 1 / 0.1 = 10$ indicating that it may roughly take at least 10 seconds or more for the sensor to turn on.

5.3 Gauge Status LED

The CCM500 is provided with a Gauge Status LED and Power Status LED to determine the gauge / filament and power status shown in [section 3.2.2](#) and described below:

Gauge Status LED:

- When LED is yellow = sensor on
- When LED is blank = sensor off
- When LED is flashing = error

Power LED:

- When LED is green = power on
- When LED is blank = power off

6 Using the gauge with different gases

InstruTech gauges are calibrated for direct readout of nitrogen or air. Do not attempt to use with other gases such as argon (Ar) or carbon dioxide (CO₂) unless accurate conversion data for N₂ to other gas is properly used. Refer to the correction factor data listed in the controller User Manual operating this device. The User Manuals for InstruTech's B-RAX or FlexRax controllers provide a more complete discussion of using correction factors when using the gauge to measure pressure of gases other than nitrogen / air.

7 Service

7.1 Calibration

Every InstruTech module is calibrated prior to shipment using nitrogen. Care should be exercised when using gases other than nitrogen N₂/air. See [Section 6](#) titled “Using the gauge with different gases”.

7.2 Troubleshooting - Operation

Indication	Possible Cause	Possible Solution
LED display on B-RAX or FlexRax controller indicates off	No power	Check cable connections and verify that power is being supplied
Displayed pressure appears very different from expected pressure	Sensor not in the proper location to measure system pressure	Ensure the sensor is located in appropriate location
	The process gas is different from the gas (nitrogen) used to calibrate the CCM500	Apply gas sensitivity correction factor if applicable
	Sensor has been dropped causing mechanical damage	Replace the Cold Cathode gauge sensor
	The gauge sensor is contaminated	Clean or replace sensor
	Leak in the vacuum system	Re-check for leak in the system Re-check that all metal seals are used when operating below 1.00×10^{-7} Torr
	Incorrect Sensitivity or CAL FACTORS C	Ensure correct values programmed in the controller
Displayed pressure is significantly lower than expected pressure	The gauge sensor is contaminated	Clean or replace sensor
	Incorrect Sensitivity and CAL FACTORS C	Ensure correct values programmed in the controller operating the CCM500
Gauge cannot be activated (unable to turn anode voltage on)	Pressure exceeds value programmed for OVER PRESS	Decrease pressure below required value
	Chamber pressure higher than 1.00×10^{-2} Torr	Decrease chamber pressure below value programmed for OVER PRESS
Gauge will not start at low pressure	Pressure is too low to initiate discharge	Repeat step to activate sensor
		Allow more time for sensor activation
		Increase pressure

7.3 Maintenance

In general, maintenance is not required for your InstruTech module. Periodic performance checks may be done by comparing the gauge to a known reference standard. When using the gauge in gases containing contaminants, periodic sensor cleaning is recommended. See the following sections on contamination and cleaning.

7.4 Contamination

The most common cause of all vacuum gauge failures is contamination of the sensor. Noisy or erratic readings, lower than expected measurements, and total gauge failure, are all possible indications of gauge contamination. Contamination can be generally characterized as either:

A) A reaction of process gases with sensor elements, or

B) An accumulation of material on the sensor elements. Sensors that fail due to chemical reaction are generally not repairable. Sensors that fail due to condensation, coatings, or particles may possibly be restored by cleaning.

A) Reactive Gases

If process gases react with the materials of construction of the sensor, the result is corrosion and disintegration of the sensor over time. Since the sensor material of construction is series 304 stainless steel, the sensor should handle most applications. If series 304 stainless steel is not compatible with the process gas, cleaning can't solve the problem because the sensor has been destroyed, you should consider using a different gauge than the CCM500.

B) Oil, Condensation, Coatings, and Particles

If the failure is due to an accumulation of material in the gauge, you may be able to restore your gauge or module by cleaning.

Oils and hydrocarbons: Exposure of the gauge internal surfaces to oils and hydrocarbons can result in sensor contamination. Some of these types of contamination may be removed by cleaning the gauge. Furthermore, if there is the possibility of oil back streaming from wet vacuum pumps, it is recommended that a filter or trap be installed to prevent contamination of components of your vacuum system.

In some vacuum processes, desorbed and sputtered materials from the process may enter vacuum components connected to the process vacuum chamber by line-of-sight transport especially under high vacuum conditions, i.e., in the molecular flow regime. To prevent materials that may be transported via line-of-sight momentum from entering your vacuum gauge or other components, it is advisable to install some form of apparatus that will block the line-of-sight. In many cases a simple 90° elbow may help prevent or reduce the transport of particles from entering your vacuum gauge.

In the event of gauge contamination you can attempt to clean the sensor. Refer to the following section for information on sensor cleaning.

7.5 Cold Cathode Sensor Replacement

The CCM500 ion gauge module is factory calibrated for the specific ion gauge transducer (sensor) installed in it. The CAL FACTORS values of the new sensor must be re-programmed in the CCM500 and controller electronics. Follow all instructions given below to replace the sensor. If you prefer, you may contact the factory for return authorization and the replacement of the sensor will be done for you at the factory.

To replace the sensor use the following procedure:

1. Turn off power to the CCM500.
2. Disconnect the cable from the CCM500.
3. Remove the CCM500 from the vacuum system.
4. Use a 3/32 in. size Hex key to remove the #4-40 socket head cap screws (SHCS) as shown below.
5. Detach the electronics from the sensor by sliding the metal electronics enclosure away from the sensor. Pull the electronics enclosure, with a continuous straight line motion, away from sensor.
6. Replace sensor. Make sure the arrow on the magnet assembly is aligned with engraved line on the anode assembly. Reinstall the 4-40 SHCS (4 each).
7. Reprogram new sensor CAL FACTORS values. The CAL Factor values are marked on the sensor endplate.

Sensor Replacement

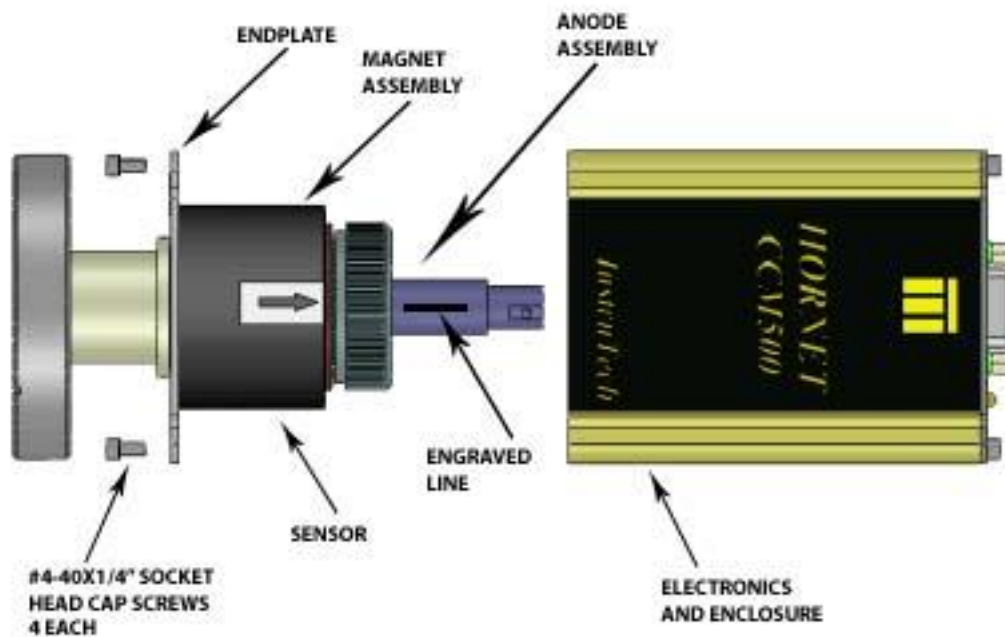

7.6 Cold Cathode Sensor Cleaning

The design of Instrutech's cold cathode includes an internal O-ring which allows for easy disassembly for cleaning. This makes the cold cathode gauge an attractive solution for use in "dirty" process applications.

To clean the cold cathode sensor, use the following procedure:

A) Detach sensor from electronics

Refer to previous [section 7.5](#) for instructions

B) Sensor Disassembly

1. Unscrew knurled knob to remove.
2. Remove anode assembly and O-ring.
3. Remove flat and wavy washer with magnet.

Note- Set magnet aside where nothing will be attracted.

C) Cleaning Instructions

1. Polish the anode surface as shown with fine emery paper.
2. Polish the inner surface of the Envelope Assembly with fine emery paper.
3. Remove any cleaning debris or residue before Reassembly.

D) Sensor Reassembly

1. Place flat and wavy washer on the magnet assembly.
2. Place O-ring back on the anode assembly.
3. Reinstall anode assembly.
4. Make sure the arrow on the magnet assembly is aligned with the engraved line on anode assembly.
5. Replace knurled knob and tighten onto assembly.

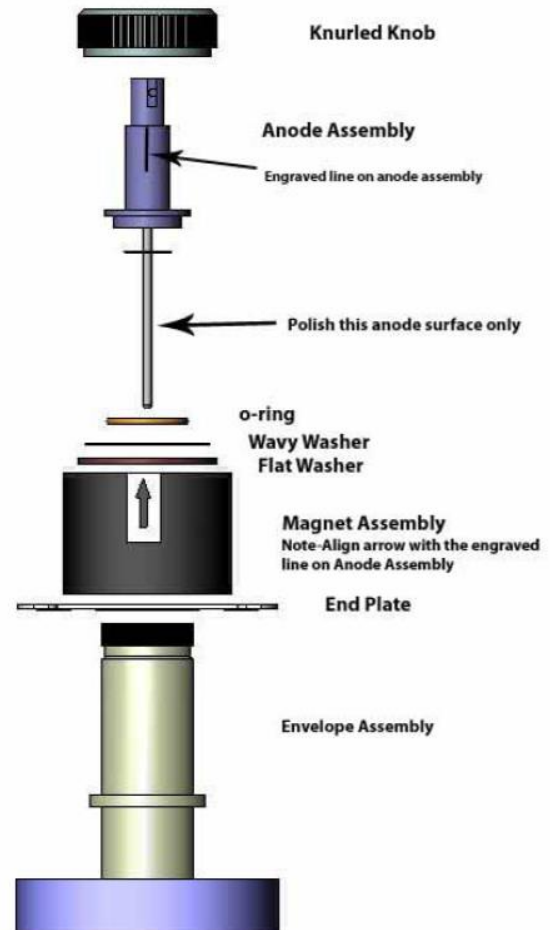

8 Factory Service and Support

If you need help setting up, operating, troubleshooting, or obtaining a return materials authorization number (RMA number) to return the module for diagnosis, please contact us during normal business hours (8:00am to 5:00pm Mountain time) Monday through Friday, at 303-651-0551. Or, e-mail us at support@instrutechinc.com.

For the safety of our employees, you must download a material disclosure form from our website at www.instrutechinc.com. Please use this form to provide a history of the gauge detailing what gases have been used. We cannot work on gauges that have been exposed to hazardous materials.

9 Warranty

SELLER warrants that its products are free of defects in workmanship and material and fit for the uses set forth in SELLER's catalog or product specifications, under the normal use and service for which they are intended.

The entire warranty obligation of SELLER is for the repair or replacement, at SELLER's option, of products or parts (examination of which shall disclose to SELLER's satisfaction that it is defective) returned, to SELLER's plant, properly identified within twelve (12) months after the date of shipment from InstruTech Plant. BUYER must obtain the approval of SELLER and a return authorization number prior to shipment.

Alteration or removal of serial numbers or other identification marks renders this warranty void. The warranty does not apply to products or components which have been abused, altered, operated outside of the environmental specifications of the product, improperly handled or installed, or units which have not been operated in accordance with SELLER's instructions. Furthermore the warranty does not apply to products that have been contaminated, or when the product or part is damaged during the warranty period due to causes other than ordinary wear and tear to the product including, but not limited to, accidents, transportation, neglect, misuse, use of the product for any purpose other than that for which it was designed.

THIS WARRANTY IS EXCLUSIVE AND IN LIEU OF ALL OTHER WARRANTIES, EXPRESS OR IMPLIED, INCLUDING ANY IMPLIED WARRANTY OF MERCHANTABILITY OR FITNESS FOR A PARTICULAR PURPOSE. THIS WARRANTY EXTENDS ONLY IN FAVOR OF THE ORIGINAL BUYER. THE BUYER'S SOLE REMEDY SHALL BE THE REPAIR OR REPLACEMENT, AS IS EXPRESSLY PROVIDED HEREIN, OF ANY WARRANTED DEFECTIVE PRODUCT OR PART, AND UNDER NO CIRCUMSTANCE SHALL SELLER BE LIABLE TO BUYER OR ANYONE ELSE FOR ANY CONSEQUENTIAL DAMAGES TO PERSONS OR PROPERTY, FOR INCIDENTAL DAMAGES OR LOSS OF TIME, FOR ANTICIPATED OR LOST PROFITS, OR ANY OTHER LOSS INCURRED BY THE BUYER RELATED TO THE PRODUCT COVERED BY THIS WARRANTY. THIS EXCLUSIVE REMEDY SHALL NOT BE DEEMED TO HAVE FAILED OF ITS ESSENTIAL PURPOSE SO LONG AS SELLER IS WILLING AND ABLE TO REPAIR OR REPLACE DEFECTIVE PARTS IN THE PRESCRIBED MANNER. THIS LIMITED WARRANTY MAY NOT BE MODIFIED BY SELLER UNLESS SUCH MODIFICATION OR WAIVER IS IN WRITING, EXECUTED BY AN AUTHORIZED OFFICER OF SELLER.



InstruTech[®], Inc.

1475 S. Fordham St.
Longmont, CO 80503
USA

Phone +1-303-651-0551
Fax +1-303-678-1754
E-mail info@instrutechinc.com
www.instrutechinc.com