

Model 220, 230

Programming Manual

Contains IEEE Programming Information

KEITHLEY

WARRANTY

Keithley Instruments, Inc. warrants this product to be free from defects in material and workmanship for a period of 1 year from date of shipment.

Keithley Instruments, Inc. warrants the following items for 90 days from the date of shipment: probes, cables, rechargeable batteries, diskettes, and documentation.

During the warranty period, we will, at our option, either repair or replace any product that proves to be defective.

To exercise this warranty, write or call your local Keithley representative, or contact Keithley headquarters in Cleveland, Ohio. You will be given prompt assistance and return instructions. Send the product, transportation prepaid, to the indicated service facility. Repairs will be made and the product returned, transportation prepaid. Repaired or replaced products are warranted for the balance of the original warranty period, or at least 90 days.

LIMITATION OF WARRANTY

This warranty does not apply to defects resulting from product modification without Keithley's express written consent, or misuse of any product or part. This warranty also does not apply to fuses, software, non-rechargeable batteries, damage from battery leakage, or problems arising from normal wear or failure to follow instructions.

THIS WARRANTY IS IN LIEU OF ALL OTHER WARRANTIES, EXPRESSED OR IMPLIED, INCLUDING ANY IMPLIED WARRANTY OF MERCHANTABILITY OR FITNESS FOR A PARTICULAR USE. THE REMEDIES PROVIDED HEREIN ARE BUYER'S SOLE AND EXCLUSIVE REMEDIES.

NEITHER KEITHLEY INSTRUMENTS, INC. NOR ANY OF ITS EMPLOYEES SHALL BE LIABLE FOR ANY DIRECT, INDIRECT, SPECIAL, INCIDENTAL OR CONSEQUENTIAL DAMAGES ARISING OUT OF THE USE OF ITS INSTRUMENTS AND SOFTWARE EVEN IF KEITHLEY INSTRUMENTS, INC., HAS BEEN ADVISED IN ADVANCE OF THE POSSIBILITY OF SUCH DAMAGES. SUCH EXCLUDED DAMAGES SHALL INCLUDE, BUT ARE NOT LIMITED TO: COSTS OF REMOVAL AND INSTALLATION, LOSSES SUSTAINED AS THE RESULT OF INJURY TO ANY PERSON, OR DAMAGE TO PROPERTY.

KEITHLEY

Keithley Instruments, Inc. • 28775 Aurora Road • Cleveland, OH 44139 • 440-248-0400 • Fax: 440-248-6168 • <http://www.keithley.com>

BELGIUM: Keithley Instruments B.V.
CHINA: Keithley Instruments China
FRANCE: Keithley Instruments Sarl
GERMANY: Keithley Instruments GmbH
GREAT BRITAIN: Keithley Instruments Ltd
INDIA: Keithley Instruments GmbH
ITALY: Keithley Instruments s.r.l.
NETHERLANDS: Keithley Instruments B.V.
SWITZERLAND: Keithley Instruments SA
TAIWAN: Keithley Instruments Taiwan

Bergensesteenweg 709 • B-1600 Sint-Pieters-Leeuw • 02/363 00 40 • Fax: 02/363 00 64
Yuan Chen Xin Building, Room 705 • 12 Yumin Road, Dewai, Madian • Beijing 100029 • 8610-62022886 • Fax: 8610-62022892
B.P. 60 • 3, allée des Garays • 91122 Palaiseau Cédex • 01 64 53 20 20 • Fax: 01 60 11 77 26
Landsberger Strasse 65 • D-82110 Germering • 089/84 93 07-40 • Fax: 089/84 93 07-34
The Minster • 58 Portman Road • Reading, Berkshire RG30 1EA • 0118-9 57 56 66 • Fax: 0118-9 59 64 69
Flat 2B, WILOCRISSA • 14, Rest House Crescent • Bangalore 560 001 • 91-80-509-1320/21 • Fax: 91-80-509-1322
Viale S. Gimignano, 38 • 20146 Milano • 02/48 30 30 08 • Fax: 02/48 30 22 74
Postbus 559 • 4200 AN Gorinchem • 0183-635333 • Fax: 0183-630821
Kriesbachstrasse 4 • 8600 Dübendorf • 01-821 94 44 • Fax: 01-820 30 81
1 Fl. 85 Po Ai Street • Hsinchu, Taiwan, R.O.C. • 886-3572-9077 • Fax: 886-3572-903

Model 220 Programmable Current Source
Model 230 Programmable Current Source
Programming Manual

©1982, Keithley Instruments, Inc.
All rights reserved.
Cleveland, Ohio, U.S.A.
Third Printing, May 2000
Document Number: 220-900-01 Rev. C

SPECIFICATIONS

IEEE-488 BUS IMPLEMENTATION:

Multiline Commands: DCL, LLO, SDC, GET, GTL, UNT, UNL, SPE, SPD.

Uniline Commands: IFC, REN, EOI, SRQ, ATN.

Interface Functions: SH1, AH1, T6, TE0, L4, LE0, SR1, RL1, PP0, DC1, DT1, C0, E1.

Internal Programmable Parameters: DISPLAY MODE, OUTPUT, Prefix (Data Format), EOI, SRQ (including mask for over limit), PROGRAM MODE, Range, Trigger Mode, Terminator Character, Inputs (SOURCE, LIMIT, DWELL TIME, 100-Point Memory Locations), Output Status, Digital Self Test.

Digital I/O Port: A separate I/O port consisting of four input and four output lines as well as common (IEEE-488) and +5VDC. Outputs will drive one TTL load. Inputs represent one TTL load. The 220/230 can be programmed to generate a "SRQ" upon any change in the four bit input data.

Mating connector supplied.

IEEE COMMAND GROUPS

ADDRESS COMMAND GROUP

LISTEN: LAG = LISTEN ADDRESS GROUP
 MLA = MY LISTEN ADDRESS
 UNL = UNLISTEN
 TALK: TAG = TALK ADDRESS GROUP
 MTA = MY TALK ADDRESS
 UNT = UNTALK
 OTA = OTHER TALK ADDRESS

ADDRESSED COMMAND GROUP

ACG = ADDRESSED COMMAND GROUP
 GET = GROUP EXECUTE TRIGGER
 GTL = GO TO LOCAL
 SDC = SELECTIVE DEVICE CLEAR

STATUS COMMAND GROUP

RQS = REQUEST SERVICE
 SRQ = SERIAL POLL REQUEST
 STB = STATUS BYTE

HANDSHAKE COMMAND GROUP

DAC = DATA ACCEPTED
 RFD = READY FOR DATA
 DAV = DATA VALID

UNIVERSAL COMMAND GROUP

ATN = ATTENTION
 DCL = DEVICE CLEAR
 IFC = INTERFACE CLEAR
 LLO = LOCAL LOCKOUT
 REN = REMOTE ENABLE
 SPD = SERIAL POLL DISABLE
 SPE = SERIAL POLL ENABLE
 END = EOI

DEVICE DEPENDENT COMMAND GROUP

Display:	D0	Source	R7	1mA (220)
	D1	Limit	R8	10mS (220)
	D2	Dwell Time	R9	100mA (220)
	D3	Memory Location		
Function:	F0	Standby	Trigger:	T0 Start On Talk
	F1	Operate		T1 Stop On Talk
Prefix:	G0	Location With Prefix		T2 Start On GET
(Data Format)	G1	Location Without Prefix		T3 Stop On GET
	G2	Buffer Address With Prefix		T4 Start On X
	G3	Buffer Address Without Prefix		T5 Stop On X
	G4	Full Buffer With Prefix		T6 Start On External Trigger
	G5	Full Buffer Without Prefix		T7 Stop On External Trigger
EOI:	K0	Send EOI	Terminator:	Y(ASCII) Any ASCII except capitals, numbers, + - / , . e
	K1	Send No EOI		Y(LF) CR LF
SRQ:	M(0-31)	Disabled; IDDC or IDDC0; Over Limit; End of Buffer; End of Dwell Time; No Remote; Input Port Change		Y(CR) LF CR
				Y(DEL) None
Program:	P0	Single	Inputs:	I Current Source (220); Current Limit (230)
	P1	Continuous		V Voltage Limit (220); Voltage Source (230)
	P2	Step		W Dwell Time
Range:	R0	Auto	I/O Port:	O(0-15) Set Output Control Bits
	R1	1nA (220); 100mV (230)	Status:	U0 Status Word
	R2	10nA (220); 1V (230)		U1 I/O Port Status
	R3	100nA (220); 10V (230)	Digital Self Test:	J0 Test Instrument
	R4	1µA (220); 100V (230)	Execute:	X Execute Command
	R5	10µA (220)		
	R6	100µA (220)		

Safety Precautions

The following safety precautions should be observed before using this product and any associated instrumentation. Although some instruments and accessories would normally be used with non-hazardous voltages, there are situations where hazardous conditions may be present.

This product is intended for use by qualified personnel who recognize shock hazards and are familiar with the safety precautions required to avoid possible injury. Read the operating information carefully before using the product.

The types of product users are:

Responsible body is the individual or group responsible for the use and maintenance of equipment, for ensuring that the equipment is operated within its specifications and operating limits, and for ensuring that operators are adequately trained.

Operators use the product for its intended function. They must be trained in electrical safety procedures and proper use of the instrument. They must be protected from electric shock and contact with hazardous live circuits.

Maintenance personnel perform routine procedures on the product to keep it operating, for example, setting the line voltage or replacing consumable materials. Maintenance procedures are described in the manual. The procedures explicitly state if the operator may perform them. Otherwise, they should be performed only by service personnel.

Service personnel are trained to work on live circuits, and perform safe installations and repairs of products. Only properly trained service personnel may perform installation and service procedures.

Exercise extreme caution when a shock hazard is present. Lethal voltage may be present on cable connector jacks or test fixtures. The American National Standards Institute (ANSI) states that a shock hazard exists when voltage levels greater than 30V RMS, 42.4V peak, or 60VDC are present. **A good safety practice is to expect that hazardous voltage is present in any unknown circuit before measuring.**

Users of this product must be protected from electric shock at all times. The responsible body must ensure that users are prevented access and/or insulated from every connection point. In some cases, connections must be exposed to potential human contact. Product users in these circumstances must be trained to protect themselves from the risk of electric shock. If the circuit is capable of operating at or above 1000 volts, **no conductive part of the circuit may be exposed.**

As described in the International Electrotechnical Commission (IEC) Standard IEC 664, digital multimeter measuring circuits (e.g., Keithley Models 175A, 199, 2000, 2001, 2002, and 2010) are Installation Category II. All other instruments' signal terminals are Installation Category I and must not be connected to mains.

Do not connect switching cards directly to unlimited power circuits. They are intended to be used with impedance limited sources. **NEVER** connect switching cards directly to AC mains. When connecting sources to switching cards, install protective devices to limit fault current and voltage to the card.

Before operating an instrument, make sure the line cord is connected to a properly grounded power receptacle. Inspect the connecting cables, test leads, and jumpers for possible wear, cracks, or breaks before each use.

For maximum safety, do not touch the product, test cables, or any other instruments while power is applied to the circuit under test. **ALWAYS** remove power from the entire test system and discharge any capacitors before: connecting or disconnecting cables or jumpers, installing or removing switching cards, or making internal changes, such as installing or removing jumpers.

Do not touch any object that could provide a current path to the common side of the circuit under test or power line (earth) ground. Always make measurements with dry hands while standing on a dry, insulated surface capable of withstanding the voltage being measured.

The instrument and accessories must be used in accordance with its specifications and operating instructions or the safety of the equipment may be impaired.

Do not exceed the maximum signal levels of the instruments and accessories, as defined in the specifications and operating information, and as shown on the instrument or test fixture panels, or switching card.

When fuses are used in a product, replace with same type and rating for continued protection against fire hazard.

Chassis connections must only be used as shield connections for measuring circuits, NOT as safety earth ground connections.

If you are using a test fixture, keep the lid closed while power is applied to the device under test. Safe operation requires the use of a lid interlock.

If a  screw is present, connect it to safety earth ground using the wire recommended in the user documentation.

The  symbol on an instrument indicates that the user should refer to the operating instructions located in the manual.

The  symbol on an instrument shows that it can source or measure 1000 volts or more, including the combined effect of normal and common mode voltages. Use standard safety precautions to avoid personal contact with these voltages.

The **WARNING** heading in a manual explains dangers that might result in personal injury or death. Always read the associated information very carefully before performing the indicated procedure.

The **CAUTION** heading in a manual explains hazards that could damage the instrument. Such damage may invalidate the warranty.

Instrumentation and accessories shall not be connected to humans.

Before performing any maintenance, disconnect the line cord and all test cables.

To maintain protection from electric shock and fire, replacement components in mains circuits, including the power transformer, test leads, and input jacks, must be purchased from Keithley Instruments. Standard fuses, with applicable national safety approvals, may be used if the rating and type are the same. Other components that are not safety related may be purchased from other suppliers as long as they are equivalent to the original component. (Note that selected parts should be purchased only through Keithley Instruments to maintain accuracy and functionality of the product.) If you are unsure about the applicability of a replacement component, call a Keithley Instruments office for information.

To clean an instrument, use a damp cloth or mild, water based cleaner. Clean the exterior of the instrument only. Do not apply cleaner directly to the instrument or allow liquids to enter or spill on the instrument. Products that consist of a circuit board with no case or chassis (e.g., data acquisition board for installation into a computer) should never require cleaning if handled according to instructions. If the board becomes contaminated and operation is affected, the board should be returned to the factory for proper cleaning/servicing.

TABLE OF CONTENTS

Paragraph	Title	Page
SECTION 1 - GENERAL INFORMATION		
1.1	Introduction	1-1
1.2	Model 220 and 230 IEEE Interface Features	1-1
1.3	Warranty Information	1-1
1.4	Manual Addenda	1-1
1.5	Safety Symbols and Terms	1-1
1.6	Using the Model 220/230 Programming Manual	1-1
1.7	IEEE Specifications	1-1
SECTION 2 - AN OVERVIEW OF THE IEEE-488 BUS		
2.1	Introduction	2-1
2.2	Bus Description	2-1
2.3	IEEE-488 Bus Lines	2-1
2.3.1	Bus Management Lines	2-1
2.3.2	Handshake Lines	2-2
2.3.3	Data Lines	2-2
2.4	Bus Commands	2-3
2.4.1	Uniline Commands	2-3
2.4.2	Universal Commands	2-3
2.4.3	Addressed Commands	2-3
2.4.4	Unaddressed Commands	2-3
2.4.5	Device-Dependent Commands	2-3
2.5	Command Codes	2-4
2.6	Command Sequences	2-4
2.6.1	Addressed Command Sequence	2-6
2.6.2	Universal Command Sequence	2-6
2.6.3	Device-Dependent Command Sequence	2-6
SECTION 3 - SYSTEM CONFIGURATION		
3.1	Introduction	3-1
3.2	Hardware Considerations	3-1
3.2.1	Typical Systems	3-1
3.2.2	Bus Connections	3-1
3.2.3	Primary Address Selection	3-3
3.2.4	Digital I/O Port	3-4
3.3	Software Considerations	3-4
3.3.1	Controller Interface Routines	3-4
3.3.2	HP-85 BASIC Statements	3-5
3.3.3	Interface Function Codes	3-5
3.3.4	Model 220/230 Interface Commands	3-6
SECTION 4 - OPERATION		
4.1	Introduction	4-1
4.2	General Bus Commands	4-1
4.2.1	REN (Remote Enable)	4-1
4.2.2	IFC (Interface Clear)	4-1
4.2.3	LLO (Local Lockout)	4-2
4.2.4	GTL (Go To Local)	4-2
4.2.5	DCL (Device Clear)	4-2
4.2.6	SDC (Selective Device Clear)	4-3
4.2.7	GET (Group Execute Trigger)	4-3
4.2.8	Serial Polling (SPE, SPD)	4-3
4.3	Device-Dependent Command Programming	4-4
4.3.1	Execute (X)	4-6
4.3.2	Display Mode (D)	4-6
4.3.3	Inputs (I, V, W, L, B)	4-6
4.3.4	I/O Port (O)	4-8
4.3.5	Function (F)	4-8
4.3.6	Data Format (G)	4-8
4.3.7	EOI Programming (K)	4-10

TABLE OF CONTENTS (CONT.)

Paragraph	Title	Page
4.3.8	SRQ Mode (M) and Status Byte Format	4-10
4.3.9	Program Mode (P)	4-13
4.3.10	Range (R)	4-13
4.3.11	Trigger Mode (T)	4-14
4.3.12	Programmable Terminator (Y).....	4-15
4.3.13	Status Word (U)	4-15
4.3.14	Digital Self-Test (J).....	4-17
4.4	Front Panel Error Messages	4-17
4.4.1	IDDC Error	4-18
4.4.2	IDDCO Error	4-18
4.4.3	No Remote Error.....	4-18
4.5	Waveform Programs.....	4-18
4.5.1	Sine Wave Approximation	4-18
4.5.2	Ramp Simulation.....	4-19
SECTION 5 - IEEE COMMAND FLOW CHARTS		
5.1	Introduction	5-1
5.2	DCL (Device Clear).....	5-1
5.3	IFC (Interface Clear)	5-1
5.4	REN (Remote Enable)	5-1
5.5	Serial Polling (SPE, SPD)	5-2
5.6	UNL (Unlisten).....	5-2
5.7	UNT (Untalk)	5-3
5.8	GET (Group Execute Trigger).....	5-3
5.9	GTL (Go To Local).....	5-4
5.10	SPC (Selective Device Clear)	5-4
5.11	Device-Dependent Commands.....	5-4

LIST OF TABLES

Table	Title	Page
2-1	IEEE-488 Bus Command Summary	2-4
2-2	Hexadecimal and Decimal Command Codes	2-4
2-3	Typical Addressed Command Sequence	2-6
2-4	Typical Device-Dependent Command Sequence.....	2-6
3-1	IEEE Contact Designations.....	3-2
3-2	Primary Address Switch Positions	3-3
3-3	Digital I/O Port Pin Assignments	3-4
3-4	HP-85 IEEE-488 Basic Statements	3-5
3-5	Model 220/230 Interface Function Codes	3-6
3-6	IEEE Command Groups	3-6
4-1	General Bus Command.....	4-1
4-2	Default Values (Status on Power Up and After SDC or DCL)	4-3
4-3	Device-Dependent Command Summary	4-5
4-4	Model 220 and 230 Display Mode Commands	4-6
4-5	Input Command Summary	4-7
4-6	I/O Port Command Parameters.....	4-8
4-7	SRQ Commands and Conditions	4-11
4-8	Status Byte Data and Error Conditions	4-12
4-9	Range Commands	4-13
4-10	I/O Port Status Values	4-16

LIST OF FIGURES

Figure	Title	Page
2-1	IEEE Bus Configuration	2-2
2-2	IEEE Handshake Sequence.....	2-2
2-3	Command Codes	2-5
3-1	System Types	3-1
3-2	IEEE-488 Connector	3-1
3-3	IEEE-488 Connections.....	3-2
3-4	Rear Panel of Model 220 or 230 Showing IEEE Connectors and Switches	3-2
3-5	Contact Assignments	3-2
3-6	Typical IEEE-488 Bus Driver (One of 16).....	3-3
3-7	Primary Address Switches (Address = 12 Shown)	3-3
3-8	Digital I/O Port Pin Assignments	3-4
4-1	Model 220 and 230 Data Formats.....	4-9
4-2	SRQ Mask Format	4-12
4-3	Status Byte Format	4-12
4-4	Status Word Format (Default Values Shown).....	4-16
4-5	I/O Status Format (Default Values Shown).....	4-16
4-6	Front Panel Error Messages	4-18
5-1	DCL Command Flow Chart.....	5-1
5-2	IFC Command Flow Chart	5-1
5-3	REN Command Flow Chart	5-2
5-4	Serial Poll Flow Chart.....	5-2
5-5	UNL Command Flow Chart.....	5-3
5-6	UNT Command Flow Chart.....	5-3
5-7	GET Command Flow Chart.....	5-4
5-8	GTL Command Flow Chart.....	5-4
5-9	SDC Command Flow Chart	5-5
5-10	Device-Dependent Command Flow Chart	5-5

SECTION 1

GENERAL INFORMATION

1.1 INTRODUCTION

The Model 220 programmable current source, and the Model 230 programmable voltage source are each supplied with a standard IEEE-488 interface. This interface adds an extra measure of versatility by allowing the transmission of data and commands over the IEEE-488 bus. The built-in IEEE interface provides all the logic necessary to interface the Models 220 and 230 to the bus using standard IEEE-488-1978 protocol. Additionally, the interface board incorporates a separate digital I/O port that may be used to interface the Models 220 and 230 to other digital instrumentation.

1.2 MODEL 220 AND 230 IEEE INTERFACE FEATURES

Important IEEE-488 interface features include:

1. IEEE-488-1978 Standard. The Model 220 or 230 communicates with other instrumentation using the same IEEE-488-1978 standards.
2. Standard IEEE Connector. A standard IEEE-488 connector is available on the rear panel of the instrument for easy connection to the IEEE bus.
3. Simple Primary Address Selection. The primary address of the Model 220 or 230 may be easily changed by using the five address switches on the rear panel of the instrument.
4. Digital I/O port. The interface also includes a digital I/O port which has separate 4-bit input and output connections. Port status may be read and controlled through commands given over the IEEE bus.
5. Programming Versatility. All Model 220/230 operation is supported by IEEE programming. In addition, numerous other IEEE commands add operating features not available from the front panel.

1.3 WARRANTY INFORMATION

Warranty information may be found inside the front cover of this manual. Should it become necessary to exercise the warranty, contact your nearest Keithley representative or the factory to determine the proper course of action. Keithley Instruments, Inc. maintains service facilities in the United States, United Kingdom, and throughout Europe. Addresses for these facilities may be found inside the front cover of this manual. Information concerning the application, operation, or service of your instrument may be directed to the applications engineer at any of these locations.

1.4 MANUAL ADDENDA

Information concerning improvements or changes to the instrument which occur after the printing of this manual

may be found on an addendum included with this manual. Be sure to review these changes before attempting to program the instrument.

1.5 SAFETY SYMBOLS AND TERMS

The following safety symbols and terms are used in this manual and may be found on the Model 220 and 230:

The symbol  on the instrument indicates that the user should refer to the operating instructions.

The symbol  on the instrument indicates that a potential of 1000V or more may be present on the terminal(s). Standard safety precautions should be observed when such dangerous voltages are encountered.

Information associated with the **WARNING** heading explains dangers that could result in personal injury or death.

Information following the **CAUTION** heading explains hazards that could damage the instrument.

1.6 USING THE MODEL 220/230 PROGRAMMING MANUAL

This manual contains all the information necessary to connect the Model 220 or 230 to the IEEE-488 bus and program the instrument from a separate bus controller. Not included in this manual is information concerning front panel operation, servicing, or maintenance of the instrument (including the interface board itself). For those aspects, refer to the Model 220 or 230 Instruction Manual.

This programming manual is divided into the following sections:

1. Section 2 contains a general description of the IEEE-488 bus and its commands.
2. Information necessary to connect the instrument to the bus and set the primary address is contained in Section 3. Also, digital I/O port information can be found in this section.
3. The bulk of the programming information may be found in Section 4. General bus commands as well as commands unique to the Models 220 and 230 are covered in detail.
4. Section 5 contains IEEE command flow charts, which could be helpful in some applications.

1.7 IEEE SPECIFICATIONS

A complete list of IEEE specifications is presented immediately preceding this section.

SECTION 2

AN OVERVIEW OF THE IEEE-488 BUS

2.1 INTRODUCTION

The IEEE-488 bus is an instrumentation data bus adopted by the IEEE (Institute of Electrical and Electronic Engineers) in 1975 and given the IEEE-488 designation. The most recent revision of bus standards was made in 1978; hence the complete description for current bus standards is the IEEE-488-1978 designation.

This section gives a brief description of the general bus structure along with an outline of bus commands. The information presented here is not intended to be an in-depth description of what is truly a very complex set of standards. More complete information on the IEEE-488 bus, which is also frequently referred to as the GPIB (General Purpose Interface Bus), is available from the IEEE and a variety of other sources.

2.2 BUS DESCRIPTION

The IEEE-488 bus was designed as a parallel data transfer medium to optimize data transfer without using an excessive number of bus lines. In keeping with this goal, the bus has only eight data lines that are used for both data and some commands. Five bus management lines and three handshake lines round out the complement of signal lines. Since the bus is of parallel design, all devices connected to the bus have the same information available simultaneously. Exactly what is done with the information by each device depends on many factors, including device capabilities.

A typical bus configuration for controlled operation is shown in Figure 2-1. The typical system will have one controller and one or more instruments to which commands are given and, in most cases, from which data is received. Generally, there are three categories that describe device operation. These designations include: controller; talker; listener.

The controller does what its name implies: it controls other devices on the bus. A talker sends data, while a listener receives data. Depending on the instrument, a particular device may be a talker only, a listener only, or both a talker and a listener.

Any given system can have only one controller (control may be passed to an appropriate device through a special command), but any number of talkers or listeners may be present up to the hardware constraints of the bus. Generally, the bus is limited to 15 devices, but this number may be reduced if higher than normal data transfer rates are required or if longer than normal cables are used.

Several devices may be commanded to listen at once, but only one device may be a talker at any given time. Otherwise, communications would be scrambled much like an individual's trying to pick out a single conversation out of a large crowd.

Before a device can talk or listen, it must be appropriately addressed. Devices are selected on the basis of their primary address; the addressed device is sent a talk or listen command derived from its primary address. Normally, each device on the bus has a unique primary address so that each may be addressed individually.

Once the device is addressed to talk or listen, appropriate bus transactions are set to take place. For example, if an instrument is addressed to talk, it will usually place its data on the bus one byte at a time. The listening device will then read this information, and the appropriate software can then be used to channel the information to the desired location.

2.3 IEEE-488 BUS LINES

The signal lines on the IEEE-488 bus are grouped into three general categories. The data lines handle bus information, while the handshake and bus management lines ensure that proper data transfer and bus operation takes place. Each of the bus lines is active low so that approximately zero volts is a logic one. The following paragraphs describe the purpose of these lines, which are shown in Figure 2-1.

2.3.1 Bus Management Lines

The bus management group is made up of five signal lines that help ensure an orderly transfer of data. These lines are used to send the uniline commands described in paragraph 2.4.

1. ATN (Attention)—The ATN line is one of the more important management lines. The state of the ATN line determines whether controller information on the data bus is to be considered data or a multiline command as described in paragraph 2.4.
2. IFC (Interface Clear)—Setting the IFC line true (low) causes the bus to go to a known state by sending the IFC command.
3. REN (Remote Enable)—Setting the REN line low sends the REN command. This sets up instruments on the bus for remote operation.
4. EOI (End Or Identify)—The EOI line is used to send the EOI command that usually terminates a multi-byte transfer sequence.
5. SRQ (Service Request)—The SRQ line is set low by a device when it requires service from the controller.

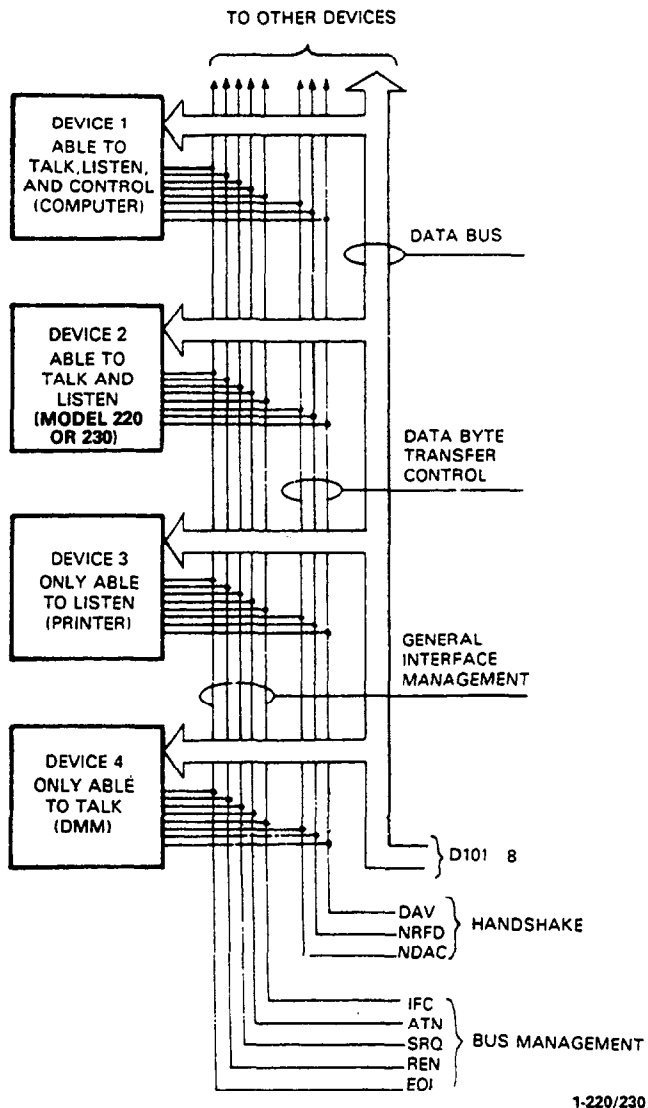

Figure 2-1. IEEE Bus Configuration

2.3.2 Handshake Lines

The bus uses three handshake lines that operate in an interlocked sequence. This method ensures reliable data transfer regardless of the transfer rate. Generally, data transfer will occur at a rate determined by the slowest active device on the bus.

One of the handshake lines is controlled by the data source, while the remaining two lines are controlled by accepting devices. The three bus handshake lines are:

1. DAV (Data Valid)—The source controls the state of the DAV line.
2. NRFD (Not Ready For Data)—The acceptor controls the state of the NRFD line.
3. NDAC (Not Data Accepted)—The acceptor also controls the state of the NDAC line.

The complete handshake sequence for one data byte is shown in Figure 2-2. Once data is on the bus, the source checks to see that NRFD is high, indicating that all devices on the bus are ready for data. At the same time NDAC should be low from the previous byte transfer. If these conditions are not met, the source must then wait until the NRFD and NDAC lines have the correct status. If the source is a controller, NRFD and NDAC must remain stable for at least 100ns after ATN is set low. Because of the possibility of bus hang up, some controllers have time-out routines to display error messages if the handshake sequence stops for any reason.

Once the NRFD and NDAC lines are properly set, the source sets the DAV line low, indicating that data on the bus is now valid. The NRFD line then goes low; the NDAC line goes high once all devices on the bus have accepted the data. Each device will release the NDAC line at its own rate, but the NDAC line will not go high until the slowest device has accepted the data byte.

After the NDAC line goes high, the source then sets the DAV line high to indicate that the data on the bus is no longer valid. At this point, the NDAC line returns to its low state. Finally, the NRFD line is released by each of the devices at their own rates, until the NRFD line finally goes high when the slowest device is ready, and the bus is set to repeat the sequence with the next data byte.

The sequence just described is used to transfer both data and multiline commands. The state of the ATN line determines whether the data bus contains data or commands as described in paragraph 2.4.

2.3.3 Data Lines

The IEEE-488 bus uses the eight data lines that allow data to be transmitted and received in a bit-parallel, byte-serial manner. These eight lines use the convention DIO1 through DIO8 instead of the more common DO through D7 binary terminology. The data lines are bidirectional and, as with the remaining bus signal lines, low is true.

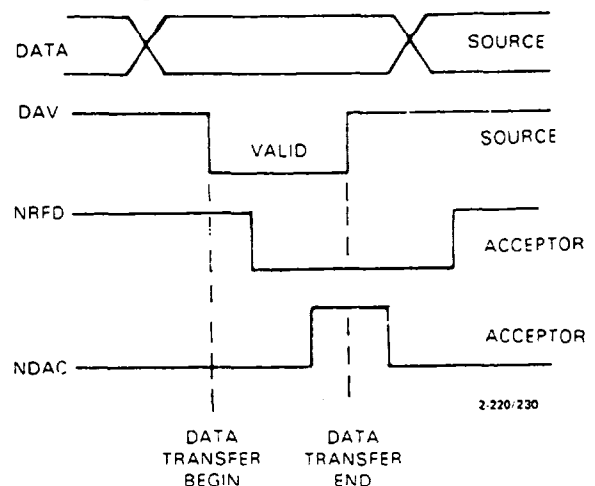

Figure 2-2. IEEE Handshake Sequence

2.4 BUS COMMANDS

While the hardware aspects of bus is essential, the interface would be essentially worthless without appropriate commands to control communications between the various instruments on the bus. This section briefly describes the purpose of the bus commands, which are grouped into the following three general categories:

1. **Uniline commands:** Sent by setting the associated bus line low.
2. **Multiline commands:** General bus commands which are sent over the data lines with the ATN line low.
3. **Device-dependent commands:** Special commands that depend on device configuration; sent over the data lines with ATN high.

These commands are summarized in Table 2-1.

2.4.1 Uniline Commands

Uniline commands are sent by setting the associated bus line low. The ATN, IFC, and REN commands are asserted only by the system controller. The SRQ command is sent by an external device. The EOI command may be sent by either the controller or an external device depending on the direction of data transfer. The following is a brief description of each command.

1. **REN (Remote Enable)**-When the controller sends the REN command, the instrument will be set up for remote operation. Generally, the REN command should be sent before attempting to program instruments over the bus.
2. **EOI (End Or Identify)**-The EOI command is used to positively identify the last byte in a multi-byte transfer sequence. This allows variable length data words to be transmitted easily.
3. **IFC (Interface Clear)**-The IFC command is sent to clear the bus and set devices to a known state. Although device configurations differ, the IFC command usually places instruments in the talk and listen idle states.
4. **ATN (Attention)**-The controller sends ATN while transmitting addresses or multiline commands. Device-dependent commands are sent with the ATN line high (false).
5. **SRQ (Service Request)**-The SRQ command is asserted by an external device when it requires service from the controller. If more than one device is present, a serial polling sequence, as described in Section 4, must be used to determine which device has requested service.

2.4.2 Universal Commands

Universal commands are multiline commands that require no addressing. All instrumentation equipped to implement the command will do so simultaneously when the command is transmitted over the bus. As with all multiline commands, the universal commands are sent over the data lines with ATN low.

1. **LLO (Local Lockout)**-The LLO command is used to lock out front panel controls on devices so equipped.

2. **DCL (Device Clear)**-After a DCL is sent, instrumentation equipped to implement the command will revert to a known state. Usually, instruments return to their power-up conditions.
3. **SPE (Serial Poll Enable)**-The SPE command is the first step in the serial polling sequence, which is used to determine which instrument has requested service with the SRQ command.
4. **SPD (Serial Poll Disable)**-The SPD command is sent by the controller to remove all instrumentation on the bus from the serial poll mode.

2.4.3 Addressed Commands

Addressed commands are multiline commands that must be preceded by a listen command derived from the device's primary address before the instrument will respond. Only the addressed device will respond to each of these commands:

1. **SDC (Selective Device Clear)**-The SDC command performs essentially the same function as the DCL command except that only the addressed device will respond. Instruments usually return to their default conditions when the SDC command is sent.
2. **GTL (Go To Local)**-The GTL command is used to remove instruments from the remote mode of operation. Also, front panel control operation will usually be restored if the LLO command was previously sent.
3. **GET (Group Execute Trigger)**-The GET command is used to trigger devices to perform a specific action that depends on device configuration. Although GET is considered to be an addressed command, many devices respond to GET without being addressed.

2.4.4 Unaddressed Commands

The two unaddressed commands are used by the controller to remove all talkers and listeners from the bus simultaneously. ATN is low when these multiline commands are asserted.

1. **UNL (Unlisten)**-All listeners are removed from the bus at once when the UNL command is placed on the bus.
2. **UNT (Untalk)**-The controller sends the UNT command to clear the bus of any talkers.

2.4.5 Device-Dependent Commands

The meaning of the device-dependent commands is determined by instrument configuration. Generally, these commands are sent as one or more ASCII characters that tell the device to perform a specific function. For example, F0 is sent to the Model 220 or 230 to place the instrument in the standby mode. For complete information on using these commands with the Model 220 or 230, refer to Section 4. The IEEE-488 bus treats device-dependent commands as data in that ATN is high (false) when the commands are transmitted.

Table 2-1. IEEE-488 Bus Command Summary

Command Type	Command	State of ATN Line*	Comments	
Uniline	REN (Remote Enable)	X	Set up for remote operation.	
	EOI	X	Sent by setting EOI low.	
	IFC (Interface Clear)	X	Clears Interface	
	ATN (Attention)	Low	Defines data bus contents.	
	SRQ (Service Request)	X	Controlled by external device.	
Multiline	Universal	LLO (Local Lockout)	Low	Locks out front panel controls.
		DCL (Device Clear)	Low	Returns device to default conditions.
		SPE (Serial Poll Enable)	Low	Enables serial polling.
	Addressed	SPD (Serial Poll Disable)	Low	Disables serial polling.
		SDC (Selective Device Clear)	Low	Returns unit to default conditions.
		GTL (Go to Local)	Low	Returns to local control.
	Unaddress	GET (Group Execute Trigger)†	Low	Triggers device.
		UNL (Unlisten)	Low	Removes all listeners from bus.
		UNT (Untalk)	Low	Removes any talkers from bus.
Device-dependent**		High	Programs Model 220 or 230 for various modes.	

† Some devices respond to GET without addressing.

*X = Don't Care

**See Section 4 for complete description.

2.5 COMMAND CODES

Each multiline command is given a unique code that is transmitted over the bus as 7-bit ASCII data. This section briefly explains the code groups which are summarized in Figure 2-3. Every command is sent with ATN low.

1. Addressed Command Group (ACG)-Addressed commands are listed in column 0(B) in Figure 2-3. Column 0(A) lists the corresponding ASCII codes.
2. Universal Command Group (UCG)-Columns 1(A) and 1(B) list the Universal commands and the corresponding ASCII codes.
3. Listen Address Group (LAG)-Columns 2(A) and 3(A) list the ASCII codes corresponding to the primary addresses listed in columns 2(B) and 3(B). For example, if the primary address of the instrument is set to 12, the LAG byte will correspond to an ASCII comma.
4. Talk Address Group (TAG)-TAG primary address values and the corresponding ASCII characters are listed in columns 4(A) through 5(B).

The preceding address groups are combined together to form the Primary Command Group (PCG). The bus also has another group of commands, called the Secondary Command Group (SCG). These are listed in Figure 2-3 for informational purposes only; the Models 220 and 230 do not respond to these commands, but other devices may have secondary addressing capability.

NOTE

Commands are normally transmitted with the 7-bit code listed in Figure 2-3. For most devices, the condition of D₇ (DIO8) is unimpor-

tant, as shown by the "Don't Care" indication in the table. Some devices, however, may require that D₇ assume a specific logic state before the commands are recognized.

Hexadecimal and decimal values for each of the commands or command groups are listed in Table 2-2. Each value in the table assumes that D₇ is set to 0.

Table 2-2. Hexadecimal and Decimal Command Codes

Command	Hex Value*	Decimal Value
GTL	01	1
SDC	04	4
GET	08	8
LLO	11	17
DCL	14	20
SPE	18	24
SPD	19	25
LAG	20-3F	32-63
TAG	40-5F	64-95
UNL	3F	63
UNT	5F	95

*Values shown with D₇ = 0.

2.6 COMMAND SEQUENCES

The proper command sequence must be sent by the controller before an instrument will respond as intended. The universal commands, such as LLO and DCL, require only that ATN be set low before the command is sent. Other commands require that the device be addressed to listen first. This section briefly describes the bus sequence for several types of commands.

D7	D6	D5	D4	D3	D2	D1	D0	COMMAND		1 (A)	2 (A)	3 (A)	4 (A)	5 (A)	6 (A)	7 (A)	X			
								0 (B)	0 (A)	1 (A)	2 (B)	3 (B)	4 (B)	5 (B)	6 (B)	7 (B)				
Bits								COMMAND		SP	SP	SP	@	P	P	P	DEL			
1	1	1	1	1	1	1	0	NUL	0 (B)	0 (A)	DLE	1 (B)	1 (A)	1 (B)	1 (A)	1 (B)	1 (A)	1 (B)	1 (A)	1 (B)
0	0	0	0	0	0	0	0	NUL	0 (B)	0 (A)	DLE	1 (B)	1 (A)	1 (B)	1 (A)	1 (B)	1 (A)	1 (B)	1 (A)	1 (B)
0	0	0	1	0	0	1	1	SOH	GTL	DC1	LLO	2 (B)	2 (A)	1 (B)	1 (A)	1 (B)	1 (A)	1 (B)	1 (A)	1 (B)
0	0	1	0	0	1	0	2	STX		DC2		3 (B)	3 (A)	2 (B)	2 (A)	2 (B)	2 (A)	2 (B)	2 (A)	2 (B)
0	0	0	1	1	0	1	3	ETX		DC3		4 (B)	4 (A)	3 (B)	3 (A)	3 (B)	3 (A)	3 (B)	3 (A)	3 (B)
0	1	0	0	0	0	4	EOT	SDC		DC4	DCL	5 (B)	5 (A)	4 (B)	4 (A)	4 (B)	4 (A)	4 (B)	4 (A)	4 (B)
0	1	0	1	0	1	5	ENQ	PPC*		NAK	PPU*	6 (B)	6 (A)	5 (B)	5 (A)	5 (B)	5 (A)	5 (B)	5 (A)	5 (B)
0	1	1	0	0	6	ACK				SYN		7 (B)	7 (A)	6 (B)	6 (A)	6 (B)	6 (A)	6 (B)	6 (A)	6 (B)
0	1	1	1	1	7	BEL				ETB		8 (B)	8 (A)	7 (B)	7 (A)	7 (B)	7 (A)	7 (B)	7 (A)	7 (B)
1	0	0	0	0	8	BS			GET	CAN	SPE	9 (B)	9 (A)	8 (B)	8 (A)	8 (B)	8 (A)	8 (B)	8 (A)	8 (B)
1	0	0	1	0	9	HT			TCT*	EM	SPD	10 (B)	10 (A)	9 (B)	9 (A)	9 (B)	9 (A)	9 (B)	9 (A)	9 (B)
1	0	1	0	1	10	LF				SUB		11 (B)	11 (A)	10 (B)	10 (A)	10 (B)	10 (A)	10 (B)	10 (A)	10 (B)
1	0	1	1	1	11	VT				ESC		12 (B)	12 (A)	11 (B)	11 (A)	11 (B)	11 (A)	11 (B)	11 (A)	11 (B)
1	1	0	0	0	12	FF				FS		13 (B)	13 (A)	12 (B)	12 (A)	12 (B)	12 (A)	12 (B)	12 (A)	12 (B)
1	1	0	1	0	13	CR				GS		14 (B)	14 (A)	13 (B)	13 (A)	13 (B)	13 (A)	13 (B)	13 (A)	13 (B)
1	1	1	0	0	14	SO				RS		15 (B)	15 (A)	14 (B)	14 (A)	14 (B)	14 (A)	14 (B)	14 (A)	14 (B)
1	1	1	1	1	15	SI				US		UNL	O	15 (B)	15 (A)	15 (B)	15 (A)	15 (B)	15 (A)	15 (B)

*PPC (Parallel Poll Configure), PPU (Parallel Poll Unconfigure), and TCT (Take Control) not implemented by Model 220/230.

NOTE: D₀ = DIO1...D₇ = DIO8
X = DON'T CARE

Figure 2-3. Command Codes

2.6.1 Addressed Command Sequence

Before a device will respond to one of these commands, it must receive a LAG command derived from its primary address. Table 2-3 shows a typical sequence for the SDC command. The LAG command assumes that the instrument is set at a primary address of 12.

Note that an UNL command is transmitted before the LAG, SDC sequence. This is generally done to remove all other listeners from the bus first so that only the addressed device responds.

2.6.2 Universal Command Sequence

The universal commands are sent by setting ATN low and then placing the command byte on the bus. For example, the following gives the LLO command:

ATN•LLO

Note that both the ATN and LLO commands are on the bus simultaneously. Also, addressing is not necessary.

2.6.3 Device-Dependent Command Sequence

Device-dependent commands are transmitted with ATN high. However, the device must be addressed to listen first before the commands are transmitted. Table 2-4 shows the sequence for the following command:

FOX

This command, which sets the Model 220 or 230 to the standby mode, is described in detail in Section 4.

Table 2-3. Typical Addressed Command Sequence

Step	Command	ATN State	Data Bus		
			ASCII	Hex	Decimal
1	UNL	Set low	?	3F	63
2	LAG*	Stays low	,	2C	44
3	SDC	Stays low	EOT	04	4
4		Returns high			

*Assumes primary address = 12.

Table 2-4. Typical Device-Dependent Command Sequence

Step	Command	ATN State	Data Bus		
			ASCII	Hex	Decimal
1	UNL	Set low	?	3F	63
2	LAG*	Stays low	,	2C	44
3	Data	Set high	F	46	70
4	Data	Stays high	0	30	48
5	Data	Stays high	X	58	88

*Assumes primary address = 12.

SECTION 3 SYSTEM CONFIGURATION

3.1 INTRODUCTION

There are two operating aspects to almost any digital interface. The IEEE-488 standard is no exception to this rule. Not only must the hardware meet certain standards, but all devices, including the controller, must have appropriate software. This section deals with important hardware and software aspects of bus operation. Also included is information pertaining to the Model 220/230 digital I/O port.

3.2 HARDWARE CONSIDERATIONS

Before the Model 220 or 230 can be used with the IEEE-488 bus, the instrument must be connected to the bus with a suitable connector. Also, the primary address must be properly selected as described in this section.

3.2.1 Typical Systems

The IEEE-488 bus is a parallel interface system. As a result, adding more devices is simply a matter of using more cables to make the desired connections. Because of this flexibility, system complexity can range from the very simple to extremely complex.

Figure 3-1 shows two typical system configurations. Figure 3-1(a) shows the simplest possible controlled system. The controller is used to send commands to the instrument, which sends data back to the controller.

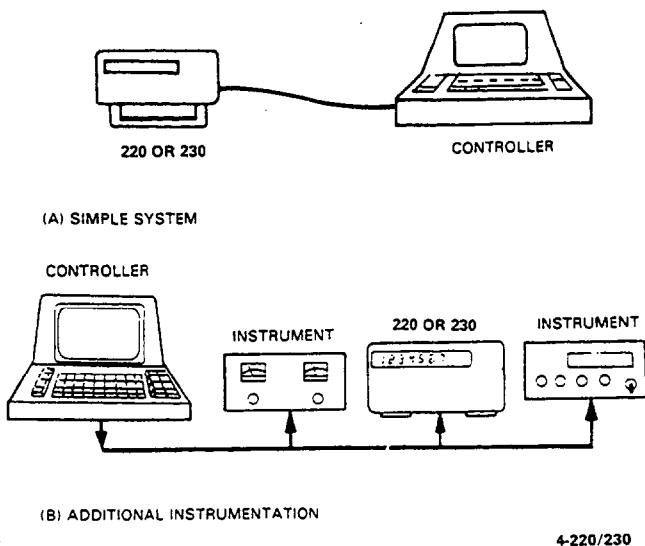

Figure 3-1. System Types

The system becomes more complex in Figure 3-1(b), where additional instrumentation is added. Depending on programming, all data may be routed through the controller, or it may be transmitted directly from one instrument to another.

For very complex applications, a much larger computer can be used. Tape drives or disks can then be used to store data.

3.2.2 Bus Connections

The Model 220 or 230 is connected to the bus through an IEEE-488 connector which is shown in Figure 3-2. This connector is designed to be stacked to allow a number of parallel connections on one instrument.

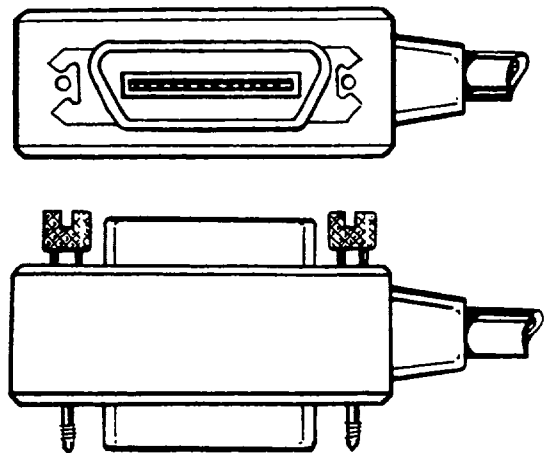

5-220/230

Figure 3-2. IEEE-488 Connector

NOTE

To avoid possible mechanical damage, it is recommended that no more than three connectors be stacked on any one instrument. Otherwise, the resulting strain may cause internal damage.

A typical connecting scheme for the bus is shown in Figure 3-3. Each cable normally has the standard IEEE connector on each end. The Keithley Model 7008 cable, which is six feet in length, is ideal for this purpose. Once the connections are made, the screws should be tightened securely. For the location of the connector on the rear panel of the Model 220 or 230, refer to Figure 3-4.

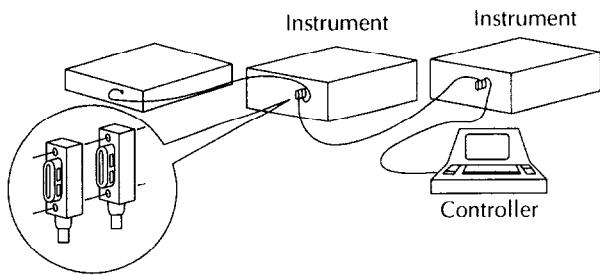

Figure 3-3. IEEE-488 Connections

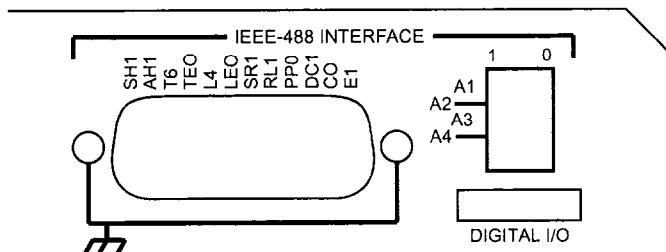

Figure 3-4. Rear Panel of Model 220 or 230 Showing IEEE Connectors and Switches

NOTE

The IEEE-488 bus is limited to a maximum of 15 devices, including the controller. Also, the maximum cable length is 20 meters. Failure to observe these limits will probably result in erratic bus operation.

Custom cables may be constructed using the information in Table 3-1 and Figure 3-5. Table 3-1 lists the contact assignments for the various bus lines, while Figure 3-5 shows contact designations. Contacts 18 through 24 are return lines for the indicated signal lines, and the cable shield is connected to contact 12. Each ground line is connected to digital common in the Model 220 or 230, but contact 12 within the instrument is left unconnected to avoid ground loops.

NOTE

The connector supplied with the Hewlett-Packard 85 HP-IB interface will require the use of the Keithley Model 7010 IEEE cable adapter. The HP-IB cable connector has an unusually large shoulder that prevents the cable connector from seating properly on the IEEE connector on the rear panel of the Model 220 or 230. Connectors on other cables, including those on the Keithley Model 7008, should seat properly without this adapter.

Table 3-1. IEEE Contact Designations

Contact Number	IEEE-488 Designation	Type
1	DIO1	Data
2	DIO2	Data
3	DIO3	Data
4	DIO4	Data
5	EOI (24)*	Management
6	DAV	Handshake
7	NRFD	Handshake
8	NDAC	Handshake
9	IFC	Management
10	SRQ	Management
11	ATN	Management
12	SHIELD**	Ground
13	DIO5	Data
14	DIO6	Data
15	DIO7	Data
16	DIO8	Data
17	REN (24)*	Management
18	Gnd, (6)*	Ground
19	Gnd, (7)*	Ground
20	Gnd, (8)*	Ground
21	Gnd, (9)*	Ground
22	Gnd, (10)*	Ground
23	Gnd, (11)*	Ground
24	Gnd, LOGIC	Ground

* Numbers in parentheses refer to signal ground return of referenced contact number. EOI and REN signal lines return on contact 24.

** The cable shield is normally connected to contact 12. This shield should be connected to ground only at the controller end to avoid ground loop problems.

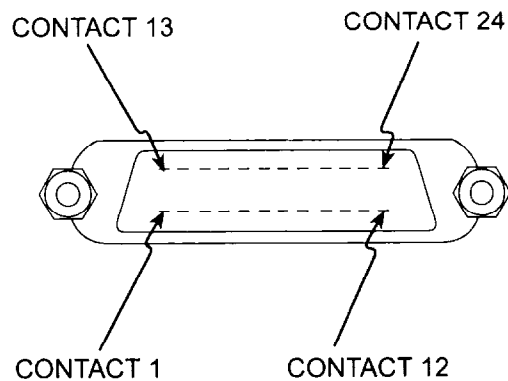

Figure 3-5. Contact Assignments

A typical signal line bus driver is shown in Figure 3-6. With the configuration shown, the driver has bidirectional capability. When the I/O control line is high, the line is configured as an output line. When the control line is low, the driver is set up for input operation. Note that not all signal lines have bidirectional capability. Some lines, such as ATN, will always be configured as an output line in the controller and as an input line for all other devices on the bus.

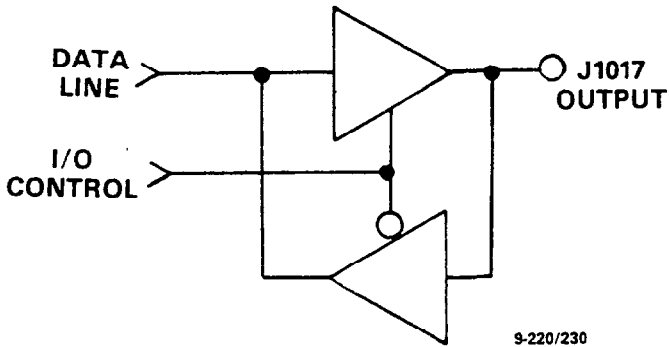

Figure 3-6. Typical IEEE-488 Bus Driver (One of 16)

3.2.3 Primary Address Selection

The Model 220 or 230 must receive a listen command before it will respond to addressed commands. Similarly, the instrument must receive a talk command before it will transmit its data string, status word, or status byte. These listen and talk commands are derived from the instrument's primary address. The Model 220 is shipped from the factory with a primary address of 12. The factory set value for the primary address of the Model 230 is 13. The primary address may be set to any value between 0 and 30 as long as address conflicts with other bus instruments are avoided. This may be done by placing the primary address switches, which are shown in Figure 3-7, in the desired positions. Note that the primary address of the instrument must agree with the address specified in the controller's programming language.

NOTE

The primary address switch positions are read only upon power-up. If the address is changed, the Model 220 or 230 must be turned off and then powered up again before the new address can be used. The primary address is shown on the display for a short period after power-up as follows: IE nn, where nn represents the primary address value.

Figure 3-7 shows the correct positions for the Model 220 factory set value of 12; if a different address is required, the primary address may be changed as outlined in Table 3-2.

NOTE

If other instrumentation is also connected to the bus, be sure that each device has a different primary address. If this precaution is not observed, erratic bus operation will probably result.

Table 3-2. Primary Address Switch Positions

Primary Address (Decimal Value)	Switch Positions				
	A5	A4	A3	A2	A1
0	0	0	0	0	0
1	0	0	0	0	1
2	0	0	0	1	0
3	0	0	0	1	1
4	0	0	1	0	0
5	0	0	1	0	1
6	0	0	1	1	0
7	0	0	1	1	1
8	0	1	0	0	0
9	0	1	0	0	1
10	0	1	0	1	0
11	0	1	0	1	1
12*	0	1	1	0	0
13**	0	1	1	0	1
14	0	1	1	1	0
15	0	1	1	1	1
16	1	0	0	0	0
17	1	0	0	0	1
18	1	0	0	1	0
19	1	0	0	1	1
20	1	0	1	0	0
21	1	0	1	0	1
22	1	0	1	1	0
23	1	0	1	1	1
24	1	1	0	0	0
25	1	1	0	0	1
26	1	1	0	1	0
27	1	1	0	1	1
28	1	1	1	0	0
29	1	1	1	0	1
30	1	1	1	1	0

*Model 220 factory set value.

**Model 230 factory set value.

NOTE: Primary Address 31 (11111) is reserved for UNL and UNT commands and should not be used.

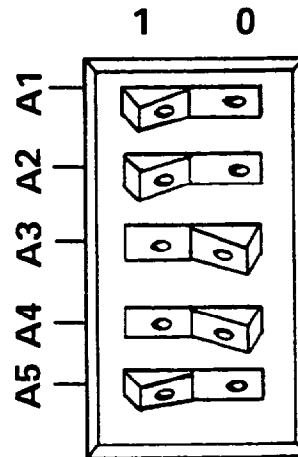

Figure 3-7. Primary Address Switches (Address = 12 Shown)

The primary address switches are binary weighted; A1 is the least significant bit, while A5 the most significant bit. For example, the binary value for the Model 220 factory set primary address of 12 is 01100. Use the tip of a pen or pencil to operate the switches.

NOTE

Instruments should not be operated with a primary address of 31 even though it is possible to set the Model 220 or 230 address switches to those positions (11111). This address is reserved for the UNT and UNL commands; erratic operation may result if primary address 31 is used.

3.2.4 Digital I/O Port

The digital I/O port is an integral part of the IEEE interface board. This port is available for convenient connections on the rear panel of the unit, as shown in Figure 3-4. The I/O port has separate 4-bit inputs and outputs as summarized in Table 3-3. Figure 3-8 shows the contact assignments for the port.

The output bit conditions may be controlled with an I/O port command. The status of both input and output lines may be checked with the I/O status command. The instrument can be programmed to generate an SRQ if the status of any input line changes. These aspects of Model 220 and 230 operation are covered in detail in Section 4.

Each output line can drive one TTL load, and each input line represents one TTL load. The signals on these lines must conform to standard TTL logic levels. The input lines are pulled up to +5V through 2.2kΩ resistors.

Table 3-3. Digital I/O Port Pin Assignments

Pin Number	Connection
1	+5V (Use for reference only)
2	+5V (Use for reference only)
3	Input (Bit 3)**
4	Input (Bit 2)
5	Input (Bit 1)
6	Input (Bit 0)*
7	Output (Bit 0)*
8	Output (Bit 1)
9	Output (Bit 2)
10	Output (Bit 3)**
11	IEEE Common
12	IEEE Common

* Bit 0 = Least Significant Bit
 ** Bit 3 = Most Significant Bit

CAUTION

Pins 11 and 12 of the digital I/O port are connected to IEEE common. Pins 1 and 2 of the port are connected to the digital +5V power supply. These connections are for reference only and must not be used to power external components.

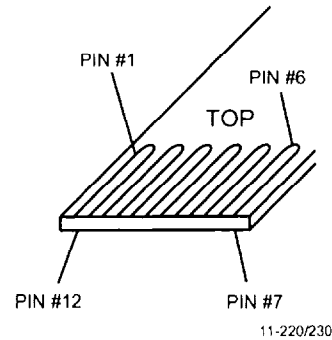

Figure 3-8. Digital I/O Port Pin Assignments

3.3 SOFTWARE CONSIDERATIONS

The most sophisticated computer in the world would be useless without the necessary software. This basic requirement is also true of the IEEE-488 bus, which requires the use of handler routines as described in this section.

3.3.1 Controller Interface Routines

Before a controller can be used with the IEEE-488 interface, the user must make certain that appropriate handler software is present within the controller. With the HP-85 computer, for example, the HP-85 interface card must be used with an additional I/O ROM, which contains the necessary handler software.

Other small computers that can be used as controllers have limited IEEE command capability. The PET/CBM computers, for example, are incapable of sending multiline commands from BASIC, although these commands can be sent through machine-language routines. The capabilities of other small computers depends on the particular interface being used. Often, little software "tricks" are required to achieve the desired results.

From the preceding discussion, the message is clear: make sure the proper software is being used with the interface. Often, the user may incorrectly suspect that a hardware problem is causing fault, when it was the software that was causing the problem all along.

3.3.2 HP-85 BASIC Statements

Many of the programming instructions covered in Section 4 use examples written in Hewlett-Packard Model 85 BASIC. The HP-85 was chosen for these examples because it has a large number of BASIC statements that control IEEE-488 operation. This section covers those HP-85 BASIC statements that are essential to Model 220 and 230 operation.

A complete list of HP-85 IEEE-488 BASIC statements is shown in Table 3-4. All the statements in the table have one or three digit arguments that must be specified. The first digit is the HP-85 interface select code, which is set to 7 at the factory. The last two digits of those statements that require a three digit argument specify the primary address. Generally, only those commands that actually require an address to be sent over the bus require that the primary address be specified in the BASIC statement.

Those statements in the table with three digit arguments assume that the primary address of the device is set at 12. Other primary addresses require that the last two digits be set to the corresponding value. For example, to send a GTL command to device 22, the following BASIC statement would be used: LOCAL 722.

Some of the statements in the table have two forms; the exact configuration used depends on the desired command. For example, CLEAR 7 will cause a DCL to be sent, while CLEAR 712 causes an SDC to be transmitted to device 12.

The third column of Table 3-4 lists the mnemonics for the command sequences. While most of these are covered elsewhere, a couple of points should be noted. As described earlier, the ATN line is set low by the controller if the data

bus contains a multiline command. This is indicated in the table by ANDing the ATN mnemonic with the first command on the bus. For example, ATN•GET means that ATN and GET are sent simultaneously.

Two commands not previously covered are MLA (My Listen Address) and MTA (My Talk Address). These are ordinary PCG (Primary Command Group) addresses sent by the HP-85 to facilitate bus operation in some situations. The Model 220 or 230 will essentially ignore these commands, but other devices may require that MLA and MTA be present in the command sequence under certain circumstances.

NOTE

The HP-85 address is set to 21 at the factory. Since each device on the bus must have a unique primary address, do not set the Model 220 or 230 to the controller's address to avoid possible conflicts.

3.3.3 Interface Function Codes

The interface function codes are part of the IEEE-488-1978 standards. These codes define an instrument's ability to support various interface functions and should not be confused with programming commands found elsewhere in this manual.

Table 3-5 lists the codes for the Models 220 and 230. These codes are also listed for convenience on the rear panel of the instrument immediately above the IEEE connector. The numeric value following each one or two letter code defines Model 220/230 capabilities as follows:

Table 3-4. HP-85 IEEE-488 BASIC Statements

Statement	Action	Bus Command Sequence
ABORTIO 7 CLEAR 7 CLEAR 712 ENTER 712;A\$	Send IFC. Send DCL. Send SDC to device 12. Device 12 addressed to talk. Data placed in A\$.	IFC ATN•DCL ATN•UNL;MTA;LAG;SDC ATN•UNL;MLA;TAG;ATN;data
LOCAL 7 LOCAL 712 LOCAL LOCKOUT 7 OUTPUT 712;A\$	Set REN False Send GTL to device 12. Send LLO. Device 12 addressed to listen. Transmit A\$.	$\overline{\text{REN}}$ ATN•UNL;MTA;LAG;GTL ATN•LLO ATN•MTA;UNL;LAG; $\overline{\text{ATN}}$;data
REMOTE 7 REMOTE 712	Set REN true. Set REN true. Address device 12 to listen.	REN REN;ATN•UNL;MTA;LAG
RESET 7 SPOLL(712)	Send IFC, cancel REN. Address device 12 to talk. Conduct serial poll.	IFC;REN; $\overline{\text{REN}}$ ATN•UNL;MLA;TAG;SPE; $\overline{\text{ATN}}$; status byte;ATN•SPD;UNT
TRIGGER 7 TRIGGER 712	Send GET without addressing. Address device 12 to listen. Send GET.	ATN•GET ATN•UNL;MTA;LAG;GET

1. SH (Source Handshake Function)-The ability for the Model 220/230 to initiate the transfer of message/data on the data bus is provided by the SH function.
2. AH (Acceptor Handshake Function)-The ability for the Model 220/230 to guarantee proper reception of message/data on the data bus is provided by the AH function.
3. T (Talker Function)-The ability for the Model 220/230 to send device-dependent data over the bus (to other devices) is provided by the T function. Model 220/230 talker capabilities exist only after the instrument has been addressed to talk.
4. L (Listener Function)-The ability for the Model 220/230 to receive device-dependent data over the bus (from other devices) is provided by the L function. Listener function capabilities of the Model 220 or 230 exist only after it has been addressed to listen.
5. SR (Service Request Function)-The ability for the Model 220/230 to request service from the controller is provided by the SR function.
6. RL (Remote—Local Function)-The ability for the Model 220/230 to be placed in the remote or local modes is provided by the RL function.
7. PP (Parallel Poll Function)-The Model 220/230 does not have parallel polling capabilities.
8. DC (Device Clear Function)-The ability for the Model 220/230 to be cleared (initialized) is provided by the DC function.
9. DT (Device Trigger Function)-The ability for the Model 220/230 to have its basic operation started (begin program operation) is provided by the DT function.
10. C (Controller Function)-The Model 220/230 does not have controller capabilities.
11. TE (Extended Talker Capabilities)-The Model 220/230 does not have extended talker capabilities.
12. LE (Extended Listener Capabilities)-The Model 220/230 does not have extended listener capabilities.

Table 3-5. Model 220/230 Interface Function Codes

Code	Interface Function
SH1	Source Handshake Capability
AH1	Acceptor Handshake Capability
T6	Talker (Basic Talker, Serial Poll, Unaddressed To Talk On LAG)
L4	Listener (Basic Listener, Unaddressed To Listen On TAG)
SR1	Service Request Capability
RL1	Remote/Local Capability
PP0	No Parallel Poll Capability
DC1	Device Clear Capability
DT1	Device Trigger Capability
C0	No Controller Capability
E1	Open Collector Bus Drivers
TE0	No Extended Talker Capabilities
LE0	No Extended Listener Capabilities

3.3.4 Model 220/230 Interface Commands

Interface commands controlling Model 220 and 230 operation are listed in Table 3-6. Not included in the table are device-dependent commands, which are covered in detail in Section 4.

Table 3-6. IEEE Command Groups

HANDSHAKE COMMAND GROUP	
	DAC = DATA ACCEPTED
	RFD = READY FOR DATA
	DAV = DATA VALID
UNIVERSAL COMMAND GROUP	
	ATN = ATTENTION
	DCL = DEVICE CLEAR
	IFC = INTERFACE CLEAR
	LLO = LOCAL LOCKOUT
	REN = REMOTE ENABLE
	SPD = SERIAL POLL DISABLE
	SPE = SERIAL POLL ENABLE
ADDRESS COMMAND GROUP	
LISTEN:	LAG = LISTEN ADDRESS GROUP
	MLA = MY LISTEN ADDRESS
	UNL = UNLISTEN
TALK:	TAG = TALK ADDRESS GROUP
	MTA = MY TALK ADDRESS
	UNT = UNTALK
	OTA = OTHER TALK ADDRESS
ADDRESSED COMMAND GROUP	
	ACG = ADDRESSED COMMAND GROUP
	GET = GROUP EXECUTE TRIGGER
	GTL = GO TO LOCAL
	SDC = SELECTIVE DEVICE CLEAR
STATUS COMMAND GROUP	
	RQS = REQUEST SERVICE
	SRQ = SERIAL POLL REQUEST
	STB = STATUS BYTE
	END = EOI

SECTION 4 OPERATION

4.1 INTRODUCTION

The Model 220 programmable current source and the Model 230 programmable voltage source are each supplied with a standard IEEE interface. Since all IEEE operation is done through commands given over the bus, IEEE operation precludes the use of operating controls in the usual sense. Instead, all operating functions are controlled by programming.

This section describes important programming functions in detail. Included are: general bus commands, device-dependent commands, status word and status byte, and other important information. The information presented in this manual assumes that the operator is familiar with all normal aspects of Model 220 or 230 operation, including front panel controls. For information on front panel operation, refer to the Model 220 or 230 Instruction Manual.

The Models 220 and 230 are very similar; both instruments are covered in this section. Most commands perform the same functions with each instrument. Where applicable, differences between the two instruments are covered separately.

NOTE

Programming examples in this section assume that the Model 220 or 230 primary address is set to 12. Those examples with addressed commands will not function unless the primary address of the instrument is set to that value. Refer to Section 3 for information on setting the primary address.

4.2 GENERAL BUS COMMANDS

General bus commands are those commands which have the same general meaning regardless of instrument configuration. These commands are grouped into two categories:

1. Addressed Commands. These commands require that the primary address of the instrument agrees with the primary address in the controller's programming language.
2. Unaddressed Commands. No primary address is required for these commands. All devices equipment to implement these commands will do so simultaneously when the command is sent.

General bus commands are summarized in Table 4-1, which also lists the HP-85 BASIC statement that sends each command. Each addressed command statement assumes a primary address of 12.

Table 4-1. General Bus Command

Command	Addressing Required ?	HP-85 BASIC Statement
REN	Yes	REMOTE 712
IFC	No	ABORTIO 7
LLO	No	LOCAL LOCKOUT 7
GTL	Yes	LOCAL 712
DCL	No	CLEAR 7
SDC	Yes	CLEAR 712
GET*	Yes	TRIGGER 712
GET*	NO	TRIGGER 7

*GET may be sent with or without addressing.

4.2.1 REN (Remote Enable)

The remote enable command is sent to the Model 220/230 by the controller to set the instrument up for remote operation. Generally, this should be done before attempting to program the instrument over the bus. The Model 220 or 230 will indicate that it is in the remote mode by illuminating its front panel REMOTE indicator.

To place the Model 220 or 230 in the remote mode, the controller must perform the following steps:

1. Set the REN line true.
2. Address the Model 220 or 230 to listen.

NOTE

Setting REN true without addressing will not cause the REMOTE indicator to turn on; however, once REN is true, the REMOTE light will turn on the next time an addressed command is received.

Programming Example-This sequence is automatically sent by the HP-85 when the following is typed into the keyboard.

REMOTE 712 (END LINE)

After the END LINE key is pressed, the Model 220 or 230 REMOTE indicator light should come on. If not, check to see that the instrument is set for the proper primary address. Also, check to see that all bus connections are tight.

4.2.2 IFC (Interface Clear)

The IFC command is sent by the controller to set the Model 220 or 230 to the talk and listen idle states. The unit will respond to the IFC command by cancelling front panel TALK or LISTEN lights if the instrument was previously placed in one of those modes. No other state changes will occur within the instrument.

To send the IFC command, the controller need only set the IFC line true.

Programming Example-Before demonstrating the IFC command, turn on the front panel REMOTE and TALK indicator lights by entering the following statements into the HP-85 computer:

```
REMOTE 712 (END LINE)
ENTER 712;A$ (END LINE)
```

The front panel REMOTE and TALK indicators should now be on. The IFC command may now be sent by entering the following statement into the HP-85:

```
ABORTIO 7 (END LINE)
```

After the END LINE key is pressed, the TALK light will turn off, indicating the Model 220 or 230 is in the talk idle state. Note that the remote mode is not cancelled.

4.2.3 LLO (Local Lockout)

The LLO command is sent by the controller to remove the Model 220 or 230 from the local operating mode. Once the unit receives the LLO command, all its front panel controls (except POWER) will be inoperative.

NOTE

The REN bus line must be true before the instrument will respond to an LLO command.

To lock out the front panel controls of the Model 220 or 230, the controller must perform the following steps:

1. Set ATN true.
2. Send the LLO command to the instrument.

Programming Example-This sequence is automatically performed by the HP-85 when the following statement sequence is typed into the keyboard:

```
REMOTE 712 (END LINE)
LOCAL LOCKOUT 7 (END LINE)
```

After the END LINE key is pressed the second time, the front panel controls are locked out. Note that no other changes occur within the instrument; all front panel modes remain as previously selected. Local control may be restored by setting REN false with the following statement:

```
LOCAL 7 (END LINE)
```

4.2.4 GTL (Go To Local)

The GTL command is used to take the instrument out of the remote mode. To send the GTL command, the controller must perform the following sequence:

1. Set ATN true.
2. Address the Model 220 or 230 to listen.
3. Place the GTL command on the bus.

NOTE

The GTL command does not restore operation of locked out Model 220 or 230 front panel controls. With some instruments, however, local

control operation may be restored by the GTL command. To restore front panel control operation of the Model 220/230, the controller must set the REN line false.

Programming Example-If the instrument is not in the remote and lockout modes, enter the following statements into the HP-85 computer:

```
REMOTE 712 (END LINE)
LOCAL LOCKOUT 7 (END LINE)
```

Check to see that the REMOTE indicator is on and that the front panel controls are locked out. The GTL command sequence is automatically sent by the HP-85 with the following statement:

```
LOCAL 712 (END LINE)
```

Note that the REMOTE light on the front panel turns off, but the front panel controls are still locked out.

Front panel control operation can be restored by setting the REN line false with the following HP-85 statement:

```
LOCAL 7 (END LINE)
```

After executing this statement, the front panel controls will again operate.

NOTE

Setting REN false with the LOCAL 7 statement will also take the instrument out of the remote mode.

4.2.5 DCL (Device Clear)

The DCL command may be used to clear the Model 220 or 230, setting it to a known state. Note that all devices on the bus equipped to respond to a DCL will do so simultaneously. When the Model 220 or 230 receives a DCL command, it will return to the default conditions listed in Table 4-2.

NOTE

Program memory will be cleared of all previously stored data when a DCL or SDC command is received. Buffer and display location pointers will be set to location one.

To send a DCL command, the controller must perform the following steps:

1. Set ATN true.
2. Place the DCL command on the bus.

Programming Example-Using the front panel controls, enter current, voltage, and dwell time data into the first few memory locations. Also, set the display to the dwell time mode and place the instrument in the continuous program mode; turn the output on with the OPERATE button. Now enter the following statement into the HP-85:

```
REMOTE 712 (END LINE)
CLEAR 7 (END LINE)
```

When the END LINE key is pressed the second time, the instrument will return to the default conditions listed in Table 4-2. The SOURCE display and STEP lights should be on and the OPERATE light should be off. Also, program memory will be cleared of any previously stored data.

Table 4-2. Default Values (Status On Power Up and After SDC or DCL)

Mode	Value	Status
Display	D0	Source
Function	F0	Standby
Data Format	G0	Location With Prefix
Self Test*	J1	Test Performed; Power Up
EOI	K0	Send EOI
Program Mode	P2	Step
Range	R0	Auto
Trigger	T6	Start On External
SRQ Mode	M0	Disabled
Terminator	Y(LF)	CR LF

*Not affected by SDC or DCL; set to 1 after running digital self test or upon power up.

4.2.6 SDC (Selective Device Clear)

The SDC command performs the same functions as the DCL command except that only the addressed device responds. This command is useful for clearing only a selected instrument instead of all instruments at once. The Model 220 or 230 will return to the default conditions listed in Table 4-2 when responding to an SDC command.

NOTE

The program memory will be cleared of all previously stored data when a DCL or SDC command is received. Also, buffer and display pointers will be set to location one.

To transmit the SDC command, the controller must perform the following steps:

1. Set ATN true.
2. Address the Model 220 or 230 to listen.
3. Place the SDC command on the bus.

Programming Example-Enter voltage, current, and dwell time data into the first few memory locations with the front panel controls. Also set the display to the memory mode and set the instrument to the single program mode. Enter the following statements into the HP-85:

```
REMOTE 712 (END LINE)
CLEAR 706 (END LINE)
```

Note that the instrument did not respond to the SDC because the command was sent with a primary address of six. Now enter the following statement into the HP-85:

```
CLEAR 712 (END LINE)
```

This time, the instrument returns to the default conditions listed in Table 4-2. Note that the program memory is cleared of previously stored data.

4.2.7 GET (Group Execute Trigger)

The GET command is sent to the Model 220 or 230 to trigger the instrument. Using the GET command is only one of several methods that can be used to start or stop Model 220 or 230 program operation. More detailed information on all trigger modes, including GET can be found in paragraph 4.3.

To send the GET command over the bus, the controller must perform the following sequence:

1. Set ATN true.
2. Address the Model 220 or 230 to listen.
3. Place the GET command on the bus.

GET can also be sent without addressing by omitting step 2.

Programming Example-Type in the following statements into the HP-85 keyboard:

```
REMOTE 712 (END LINE)
CLEAR 712 (END LINE)
```

The instrument should return to the default values listed in Table 4-2.

Place the instrument in the continuous program mode and start-on-GET trigger mode with the following statement:

```
OUTPUT 712; "P1T2X" (END LINE)
```

When the END LINE key is pressed, the CONTINUOUS program light on the front panel of the instrument will turn on.

The instrument may be triggered to start with the following statement:

```
TRIGGER 712 (END LINE)
```

The front panel START/STOP light will turn on, indicating the instrument has been triggered. To stop the instrument, enter the following statements into the HP-85 keyboard:

```
OUTPUT 712; "T3X" (END LINE)
TRIGGER 712 (END LINE)
```

When END LINE is pressed the second time, the front panel START/STOP light will go out, showing the instrument has received the trigger.

NOTE

The Model 220/230 will also respond to GET without addressing. This command is sent with the following HP-85 statement: TRIGGER 7.

The preceding examples use device-dependent commands to place the instrument in the appropriate trigger modes. These commands are covered in detail in paragraph 4.3.

4.2.8 Serial Polling (SPE, SPD)

The serial polling sequence is used to obtain the Model 220 or 230 status byte. Usually, the serial polling sequence is used to determine which of several devices has requested service over the SRQ line. However, the serial polling

sequence may be used at any time to obtain the status byte from the Model 220 or 230. For more information on status byte format, refer to paragraph 4.3.8.

The serial polling sequence is conducted as follows:

1. The controller sets the ATN line true.
2. The SPE (Serial Poll Enable) command is placed on the bus by the controller.
3. The Model 220 or 230 is addressed to talk.
4. The controller sets ATN false.
5. The instrument then places its status byte on the bus to be read by the controller.
6. The controller then sets the ATN line low and places SPD (Serial Poll Disable) on the bus to end the serial polling sequence.

Steps 3 through 5 may be repeated for other instruments on the bus by using the correct talk address for each instrument. ATN must be true when the talk address is transmitted and false when the status byte is read.

Programming Example-The HP-85 SPOLL statement automatically performs the serial polling sequence. To demonstrate serial polling, momentarily power down the Model 220 or 230 and enter the following statements into the HP-85 keyboard:

```
REMOTE 712 (END LINE)
S = SPOLL (712) (END LINE)
DISP S (END LINE)
```

When END LINE is pressed the second time, the computer performs the serial polling sequence. When END LINE is pressed the last time, the status byte value (0) is displayed on the CRT. The status byte has a value of 0 with this example because no bits in the byte are set. Paragraph 4.3.8 covers the status byte format in detail.

4.3 DEVICE-DEPENDENT COMMAND PROGRAMMING

IEEE device-dependent commands are sent to the Model 220 or 230 to control various operating modes such as function, display mode, current or voltage output, voltage or current limit, and program mode. Each command is made up of an ASCII alpha character followed by one or more numbers designating specific parameters. For example, a voltage value is programmed by sending an ASCII "V" followed by numbers designating the actual voltage value. The IEEE bus treats device-dependent commands as data in that ATN is high when the commands are transmitted.

A number of commands may be grouped together in one string. A command string is terminated by an ASCII "X" character which tells the instrument to execute the command string. There is no limit as to the number of characters that can be contained in one string as far as the Model 220 or 230 is concerned, although string length may be limited by controller capabilities.

If an illegal command or command parameter is present within a command string, the instrument will:

1. Ignore the entire command string.
2. Display appropriate front panel error messages.
3. Set certain bits in its status byte.
4. Generate an SRQ if programmed to do so.

These programming aspects are covered in paragraphs 4.3.8 and 4.4.

HP-85 examples are included throughout this section to clarify programming.

Before using a programming example, it is recommended that the instrument be set to its default values by sending an SDC over the bus. See paragraph 4.2.6 for information on using the SDC command.

NOTE

Program memory will be cleared of previously stored data when an SDC command is sent to the instrument.

If the HP-85 should become "hung up" at any point, operation may be restored by holding the SHIFT key down and then pressing RESET on the keyboard.

In order to send a device-dependent command, the controller must perform the following sequence:

1. Set ATN true.
2. Address the Model 220 or 230 to listen.
3. Set ATN false.
4. Send the command string one byte at a time.

Programming Example-Device-dependent commands are sent by the HP-85 using the following statement:

```
OUTPUT 712; A$
```

A\$ in this case contains the ASCII characters that form the command string.

NOTE

REN must be true when attempting to program the Model 220/230. If REN is false, the instrument will respond with a no remote error message as described in paragraph 4.4.

Commands that affect both the Model 220 current source and the Model 230 voltage source are listed in Table 4-3. Most commands affect both instruments in the same way. However, some important differences between the Models 220 and 230 should be noted:

1. The D0 command sets the display to view the current source value on the Model 220 and the voltage source value on the Model 230.
2. The D1 command sets the display to view the voltage limit on the Model 220 and the current limit on the Model 230.
3. The I command sets the current source value on the Model 220; it sets the current limit on the Model 230.

Table 4-3. Device-Dependent Command Summary

Mode	Command	Model 220 Current Source	Model 230 Voltage Source
Display	D0 D1 D2 D3	Current Source Voltage Limit Dwell Time Memory Location	Voltage Source Current Limit Dwell Time Memory Location
Function	F0 F1	Standby (Voltage Limit < 32V) Operate (Set to Programmed Value)	Standby (Current Limit = 2mA) Operate (Set to Programmed Value)
Prefix (Data Format)	G0 G1 G2 G3 G4 G5	Location With Prefix Location Without Prefix Buffer Address With Prefix Buffer Address Without Prefix Full Buffer With Prefix Full Buffer Without Prefix	
EOI	K0 K1	Send EOI Send No EOI	
SRQ (0-31)*	M0 M1 M2 M4 M8 M16	Disabled IDDC, IDDCO, No Remote Over Voltage Limit End of Buffer End of Dwell Time Input Port Change	Disabled IDDC, IDDCO, No Remote Over Current Limit End of Buffer End of Dwell Time Input Port Change
Program	P0 P1 P2	Single Continuous Step	
Range	R0 R1 R2 R3 R4 R5 R6 R7 R8 R9	Auto 1nA 10nA 100nA 1µA 10µA 100µA 1mA 10mA 100mA	Auto 100mV 1V 10V 100V
Trigger	T0 T1 T2 T3 T4 T5 T6 T7	Start On Talk Stop On Talk Start On GET Stop On GET Start On X Stop On X Start On External Trigger Stop On External Trigger	
Terminator	Y(ASCII) Y(LF) Y(CR) Y(DEL)	Any ASCII except capitals, numbers, + - / . , e CR LF LF CR None	
Inputs	I V W B L	Current Source Voltage Limit Dwell Time Buffer Address Memory Location	Current Limit Voltage Source Dwell Time Buffer Address Memory Location
I/O Port	O(0-15)	Set Output Control Bits	
Status	U0 U1	Send Status Word Send I/O Port Status	
Digital Self Test	J0	Test Instrument, Set J Byte in Status Word	
Execute	X	Execute Other Device-Dependent Commands	

*May be programmed to generate SRQ under more than one condition.

4. The V command sets the voltage source value on the Model 230; it sets the voltage limit on the Model 220.
5. The range commands for the two instruments perform different functions. These commands affect the current output of the Model 220 and the voltage output of the Model 230.

All the commands listed in Table 4-3 are covered in detail in the following paragraphs.

4.3.1 Execute (X)

The execute command is implemented by sending an ASCII "X" over the bus. Its purpose is to tell the Model 220 or 230 to execute other device-dependent commands. Generally, the "X" character is the last byte in the command string. The execute character also controls instrument operation in the T4 and T5 trigger modes as described in paragraph 4.3.11.

NOTE

Command strings sent without an execute character will not be executed at that time, but they will be stored in the command buffer. The next time an execute character is received, the stored commands will be executed, assuming all commands in the previous string were valid.

Programming Example-Enter the following statements into the HP-85 keyboard:

```
REMOTE 712 (END LINE)
OUTPUT 712; "X" (END LINE)
```

When the END LINE key is pressed the second time, the front panel LISTEN light comes on, showing that the instrument received the command. No other changes will occur with this example because no other commands were sent.

4.3.2 Display Mode (D)

The display mode commands perform the same operations as the four front panel DISPLAY pushbuttons on the instrument. Through use of these commands, the user can set the display to view the source value, current (220) or voltage (230) limit, dwell time, and memory location. The display mode commands for both the Model 220 and 230 are summarized in Table 4-4. Upon power-up, or after receiving a DCL or SDC command, the instrument will be in the D0 display mode.

Programming Example-Set the instrument to view the source value with the front panel SOURCE button and enter the following statements into the HP-85 keyboard:

```
REMOTE 712 (END LINE)
OUTPUT 712; "D3X" (END LINE)
```

After this statement sequence is executed, the instrument display will show the memory location. The SOURCE indicator will be off, and the MEMORY light will be on.

Table 4-4. Model 220 and 230 Display Mode Commands

Command	Model 220 Display	Model 230 Display
D0	Current Source	Voltage Source
D1	Voltage Limit	Current Limit
D2	Dwell Time	Dwell Time
D3	Memory Location	Memory Location

4.3.3 Inputs (I,V,W,L,B)

The input commands control current, voltage, and dwell times that can be stored within the various memory locations in the instrument. In addition, two of the commands control pointers that determine the actual memory location into which data is to be stored.

The Models 220 and 230 each have a 100 point memory for program data storage. In order to easily identify any one of these locations for data storage, two separate pointers are used. The display location pointer points to the memory location displayed on the front panel; data entered from the front panel will be stored in this location. The IEEE buffer address pointer points to the location into which input command (I,V,W) data is to be stored.

NOTE

The IEEE buffer and display location pointers also affect data transmitted from the Model 220 or 230 to another device. In the G0 and G1 prefix modes, location pointer data will be sent; in G2 and G3 prefix modes, buffer pointer data will be transmitted.

The input commands that affect Model 220 and 230 operation are:

- I Stores the current source (Model 220) or current limit (Model 230) into the memory slot indicated by the IEEE buffer address pointer.
- V Stores the voltage source (Model 230) or voltage limit (Model 220) into the memory slot indicated by the IEEE buffer address pointer.
- W Stores the dwell time into the memory location indicated by the IEEE buffer address pointer.
- L Sets the display location pointer to the commanded value.
- B Sets the IEEE buffer address pointer to the command value.

A complete summary of input commands along with the format of each is shown in Table 4-5. The parameter for each command may be entered in direct or scientific notation as long as the allowable range for each command is not exceeded. Some examples for the various commands are shown below.

DESIRED RESULT COMMAND VARIATIONS

7.5mA current (Model 220)	I7.5E-3; I.0075; I.75E-2; I.075E-1
6.3V voltage (Model 230)	V6.3; V.63E1
27ms dwell time	W27E-3; W2.7E-2; W.027
Location pointer to #57	L57; L5.7E1
Buffer pointer to #86	B86; B8.6E1

NOTES:

1. An IDDCO (Illegal Device-Dependent Command Option) error will occur if the input command parameter is outside the legal range. A front panel error message will indicate this error; the instrument may also be programmed to generate an SRQ if such an error occurs, as described in paragraph 4.3.8.
2. The Model 230 current limit may be set to only one of three values:
 I0 = 2mA limit
 I1 = 20mA limit
 I2 = 100mA limit

3. A zero dwell time cannot be programmed into memory location one.
4. Dwell time accuracy is guaranteed only if the IEEE bus is idle.

Programming Example-Enter the following program into the HP-85:

PROGRAM	COMMENTS
10 DIM A\$ [100]	Dimension A\$ for 100 characters
20 REMOTE 712	Set instrument up for remote operation.
30 CLEAR 712 @ OUTPUT 712; "M1X"	Return instrument to default conditions. Enable SRQ on error.

40 CLEAR	Clear CRT.
50 DISP "COMMAND";	Prompt for command input.
60 INPUT A\$	Input command string.
70 OUTPUT 712;A\$	Send command string to instrument.
80 S = SPOLL (712)	Conduct serial poll; read status byte.
90 IF BIT(S,5) = 0 THEN 50	Check for error conditions
100 IF BIT (S,0) THEN DISP "ILLEGAL COMMAND"	Check for IDDC.
110 "IF BIT (S,1) THEN DISP "ILLEGAL COMMAND OPTION"	Check for IDDCO.
120 GOTO 50	Repeat
130 END	

After the program is entered, depress the HP-85 RUN key. When the computer prompts for a command input, enter the desired command, including the command letter prefix; several commands may be grouped together in one input string. Be sure to terminate each command string with the execute (X) character. Programmed data may be observed by using the front panel display. Remember that bus data is stored in the memory slot indicated by the buffer address pointer--not the location indicated by the display location pointer, unless, of course, both pointers point to the same memory location.

NOTE

Buffer pointer and location address pointer status can be read by using the appropriate prefix mode as described in paragraph 4.3.6.

Table 4-5. Input Command Summary

Model 220 Current Source			Model 230 Voltage Source		
Command*	Controls	Allowable Range	Command*	Controls	Allowable Range
$I \pm n.nnnnE \pm nn^{**}$	Current Source Value, Amperes	0-101mA† (500fA steps)	$V \pm n.nnnnE \pm nn^{**}$	Voltage Source Value, Volts	0-101V† (50µV steps)
$Vn.nnE \pm nn$	Voltage Limit, Volts	1-105V in 1V steps	$In.nnE \pm nn$	Current Limit, Amperes	0 = 2mA 1 = 20mA 2 = 100mA
$Wn.nnnE \pm nn$	Dwell Time, Seconds	0;3ms to 999.9s in 1ms steps	$Wn.nnnE \pm nn$	Dwell Time, Seconds	0;3ms to 999.9s in 1ms steps
$Bn.nnE \pm nn$	IEEE Buffer Address	1 to 100	$Bn.nnE \pm nn$	IEEE Buffer Address	1 to 100
$Ln.nnE \pm nn$	Display Location Pointer	1 to 100	$Ln.nnE \pm nn$	Display Location Pointer	1 to 100

NOTE: n = numeric digit

†Auto range limits shown.

*Commands may be entered in normal or scientific notation; scientific notation format shown.

**Least significant digit of mantissa must be 0 or 5.

4.3.4 I/O Port (O)

The I/O port command controls the status of the four output bits on the digital I/O port on the rear panel of the instrument. Information on I/O port pin assignments can be found in Table 3-3. The I/O port command consists of the ASCII "O" character followed by the decimal number that sets the control bits as listed in Table 4-6. Upon power-up, or after a DCL or SDC, the four output lines will be set low.

Table 4-6 I/O Port Command Parameters

Command Parameter*	Output Bit Status			
	Bit 3	Bit 2	Bit 1	Bit 0
0	0	0	0	0
1	0	0	0	1
2	0	0	1	0
3	0	0	1	1
4	0	1	0	0
5	0	1	0	1
6	0	1	1	0
7	0	1	1	1
8	1	0	0	0
9	1	0	0	1
10	1	0	1	0
11	1	0	1	1
12	1	1	0	0
13	1	1	0	1
14	1	1	1	0
15	1	1	1	1

*Parameter must be preceded by ASCII letter "O".

Programming Example-Enter the following statement sequence into the HP-85 computer:

```
REMOTE 712 (END LINE)
OUTPUT 712; "O15X" (END LINE)
```

When END LINE is pressed the second time, the four output bits go high.

4.3.5 Function (F)

The function commands control the actual output of the Model 220 or 230 source. These commands perform the same operations as the front panel OPERATE button. The output of the Model 220 and 230 may be controlled by bus commands as follows:

F0 Standby-The source output will be set to zero. (Model 220 voltage limit < 32V. Model 230 current limit = 2mA).

F1 Operate-The output will be programmed to the source value in the present display memory location.

Programming Example-Using the front panel OPERATE button, turn the instrument output off and enter the following statements into the HP-85:

```
REMOTE 712 (END LINE)
OUTPUT 712; "F1X" (END LINE)
```

When END LINE is pressed the second time, the front panel OUTPUT indicator comes on.

4.3.6 Data Format (G)

When addressed to talk, the instrument will send a data string containing information on programmed current, voltage, dwell time, and memory or buffer locations. Through use of the data format command, the user has control over the following aspects of the data string:

1. Whether or not the instrument sends appropriate prefixes imbedded in the data string.
2. Whether the entire buffer or only one display location or IEEE buffer location is transmitted.

Data format commands that affect Model 220 and 230 operation are:

- G0 Transmit display memory location with prefixes.
- G1 Transmit display memory location without prefixes.
- G2 Transmit IEEE buffer address location with prefixes.
- G3 Transmit IEEE buffer address location without prefixes.
- G4 Transmit entire program memory with prefixes.
- G5 Transmit entire program memory without prefixes.

The general format for each of these commands is shown in Figure 4-1. The most significant digit of each data element is forced so one digit always appears to the left of the decimal point. Returned values for both Models 220 and 230 are shown. Upon power-up, or after receiving a SDC or DCL, the G0 mode is enabled.

NOTES:

1. The data format commands affect the format of the I/O status and instrument status words. In the G0, G2, and G4 modes, the word prefixes are sent. In the G1, G3, and G5 modes, the prefixes are omitted.
2. In the G0 through G3 modes, EOI and programmed terminators will be sent (if so programmed) at the end of each location or buffer address. In the G4 and G5 modes, EOI and programmed terminators will be sent only at the end of the entire buffer transmission.
3. Transmission of the normal data string is superseded by the status word (U) command. The instrument will transmit the status word instead of the normal data string once each time the status command is given when addressed to talk in the normal manner.
4. The "N" (Normal) prefix on the current source (220) or voltage source (230) will change to "O" (Overlimit) if the voltage limit (220) or current limit (230) is exceeded.
5. The entire program memory is transmitted in the G4 and G5 modes whether or not data is stored in every location.

In order to obtain the data string from the instrument, the controller must perform the following bus sequence:

1. Set ATN true.
2. Address the Model 220 or 230 to talk.

Prefix Mode	Model 220 Current Source*				Model 230 Voltage Source*			
G0	Current Source $\text{NDCI} \pm n.nnnnE \pm n,$ Prefix Mantissa Exponent	Voltage Limit $V \pm n.nn00E \pm n,$	Dwell Time $W + n.nnnnE \pm n,$	Display Location $L + n.nn00E \pm n$	Voltage Source $\text{NDCV} \pm n.nnnnE \pm n,$ Prefix Mantissa Exponent	Current Limit $I \pm n.nn00E \pm n,$	Dwell Time $W + n.nnnnE + n,$	Display Location $L + n.nn00E + n$
G1	Current Source $\pm n.nnnnE \pm n,$	Voltage Limit $+ n.nn00E \pm n,$	Dwell Time $+ n.nnnnE \pm n,$	Display Location $+ n.nn00E + n$	Voltage Source $\pm n.nnnnE \pm n,$	Current Limit $\pm n.nn00E \pm n,$	Dwell Time $+ n.nnnnE + n,$	Display Location $+ n.nn00E + n$
G2	Current Source $\text{NDCI} \pm n.nnnE \pm n,$	Voltage Limit $V \pm n.nn00E + n,$	Dwell Time $W + n.nnnnE + n,$	Buffer Address $B + n.nn00E + n$	Voltage Source $\text{NDCV} \pm n.nnnE \pm n,$	Current Limit $I \pm n.nn00E \pm n,$	Dwell Time $W + n.nnnnE + n,$	Buffer Address $B + n.nn00E + n$
G3	Current Source $\pm n.nnnnE + n,$	Voltage Limit $\pm n.nn00E + n,$	Dwell Time $+ n.nnnnE \pm n,$	Buffer Address $+ n.nn00E + n$	Voltage Source $\pm n.nnnnE \pm n,$	Current Limit $\pm n.nn00E \pm n,$	Dwell Time $+ n.nnnnE + n,$	Buffer Address $+ n.nn00E + n$
G4	Current Source $\text{NDCI} \pm n.nnnnE \pm n,$ $\text{NDCI} \pm n.nnnnE \pm n,$ $\text{NDCI} \pm n.nnnnE \pm n,$ $\text{NDCI} \pm n.nnnnE \pm n,$	Voltage Limit $V \pm n.nn00E + n,$ $V \pm n.nn00E + n,$ $V \pm n.nn00E \pm n,$ $V \pm n.nn00E + n,$	Dwell Time $W + n.nnnnE \pm n,$ $W + n.nnnnE \pm n,$ $W + n.nnnnE \pm n,$ $W + n.nnnnE + n,$	Buffer Address $B + 1.nn00E + 0,$ $B + 2.nn00E + 0,$ $B + 3.nn00E + 0,$ $B + 1.nn00E + 2,$	Voltage Source $\text{NDCV} \pm n.nnnnE \pm n,$ $\text{NDCV} \pm n.nnnnE \pm n,$ $\text{NDCV} \pm n.nnnnE \pm n,$ $\text{NDCV} \pm n.nnnnE \pm n,$	Current Limit $I \pm n.nn00E + n,$ $I \pm n.nn00E + n,$ $I \pm n.nn00E \pm n,$ $I \pm n.nn00E + n,$	Dwell Time $W + n.nnnnE \pm n,$ $W + n.nnnnE \pm n,$ $W \pm n.nnnnE \pm n,$ $W \pm n.nnnnE + n,$	Buffer Address $B + 1.nn00E + 0,$ $B + 2.nn00E + 0,$ $B + 3.nn00E + 0,$ $B + 1.nn00E + 2,$
G5	Current Source $\pm n.nnnnE \pm n,$ $\pm n.nnnnE \pm n,$ $\pm n.nnnnE \pm n,$ $\pm n.nnnnE \pm n,$	Voltage Limit $\pm n.nn00E \pm n,$ $\pm n.nn00E \pm n,$ $\pm n.nn00E \pm n,$ $\pm n.nn00E \pm n,$	Dwell Time $+ n.nnnnE \pm n,$ $+ n.nnnnE \pm n,$ $+ n.nnnnE \pm n,$ $+ n.nnnnE \pm n,$	Buffer Address $+ 1.nn00E + 0,$ $+ 2.nn00E + 0,$ $+ 3.nn00E + 0,$ $+ 1.nn00E + 2,$	Voltage Source $\pm n.nnnnE \pm n,$ $\pm n.nnnnE \pm n,$ $\pm n.nnnnE \pm n,$ $\pm n.nnnnE \pm n,$	Current Limit $\pm n.nn00E + n,$ $\pm n.nn00E + n,$ $\pm n.nn00E + n,$ $\pm n.nn00E + n,$	Dwell Time $+ n.nnnnE \pm n,$ $+ n.nnnnE \pm n,$ $+ n.nnnnE \pm n,$ $+ n.nnnnE \pm n,$	Buffer Address $+ 1.nn00E + 0,$ $+ 2.nn00E + 0,$ $+ 3.nn00E + 0,$ $+ 1.nn00E + 2,$

NOTE: n = digit between 0 and 9.

*Spaces shown between groups are for clarification only and do not exist on actual data strings.

12-220/230

Figure 4-1. Model 220 and 230 Data Formats

3. Set ATN false.
4. Input the data string one byte at a time.

Programming Example-The programming example below prompts for current and voltage values to be stored in the first five memory locations and then requests data from the Model 220/230 in each of the six prefix modes.

PROGRAM	COMMENTS
10 DIM A\$ [5100]	Dimension A\$ for 5100 characters
20 REMOTE 712 @ CLEAR	Set instrument up for remote operation. Clear CRT.
30 CLEAR 712 @ OUTPUT 712; "M1X"	Return to default conditions. Turn on SRQ.
40 FOR B = 1 TO 5	Loop five times.
50 DISP "CURRENT #";B;	Prompt for current input.
60 INPUT I	Input current value.
70 DISP "VOLTAGE #";B;	Prompt for voltage.
80 INPUT V	Input voltage value.
90 OUTPUT 712; "B";B;"L";B;"I"; ";"V";V;"W1X"	Send buffer, location pointers; current; voltage; dwell time.
100 S = SPOLL (712)	Obtain status byte.
110 IF BIT (S,5) = 0 THEN 150	Check for error conditions.
120 IF BIT (S,0) THEN DISP "ILLEGAL COMMAND"	Check for IDDC.
130 IF BIT (S,1) THEN DISP "ILLEGAL COMMAND OPTION"	Check for IDDCO
140 GOTO 50	
150 NEXT B	
160 CLEAR	Clear CRT.
170 OUTPUT 712; "L1X"	Set display pointer to location one.
180 FOR I = 0 TO 5	Loop six times.
190 OUTPUT 712; "G";I;"X"	Set prefix mode.
200 ENTER 712; A\$	Feed data string into computer.
210 DISP A\$	Display on CRT.
220 NEXT I	
230 END	

Once the program is entered, press the HP-85 RUN key. The program will prompt for five sets of voltage and current values. Enter these values without command letters or execute characters. If illegal values are entered, the program will display error messages and ask again for inputs.

Once the values are stored in the instrument's first five memory locations, the program sets the data format to each of the six prefix modes, requesting and displaying data with each. Line 170 of the program returns the display pointer to location one; the buffer pointer is left at location five, so it is easy to verify that G0 and G1 modes transmit display loca-

tion data, but the G2 and G3 modes transmit buffer address data. Note that a number of seconds pass in the G4 and G5 modes before data is displayed because the entire buffer must be assembled and then transmitted to the computer.

4.3.7 EOI Programming (K)

The EOI (End Or Identify) line is set low by a device during the last byte of its data transfer sequence. In this way, the last byte is positively identified, allowing data words of different lengths to be transmitted. Normally, the Model 220 or 230 is programmed to assert EOI during the last byte of its data string or status word. Information on instrument data may be found in paragraph 4.3.6, while status word information is contained in paragraph 4.3.8. EOI response of the instrument may be programmed as follows:

K0 Send EOI during last byte.

K1 Send No EOI.

Upon power-up, or after receiving an SDC or DCL, the instrument will be in the K0 mode.

Programming Example-The EOI command will be suppressed with the following statement sequence:

REMOTE 712 (END LINE)

OUTPUT 712; "K1X" (END LINE)

Note that the HP-85 does not rely on EOI to mark the end of data transmission. Some controllers, however, may require that EOI be present at the end of transmission.

NOTE

In the G4 and G5 prefix modes, EOI is transmitted only at the end of the complete program memory transmission; not during the last byte of each IEEE buffer or memory location.

4.3.8 SRQ Mode (M) and Status Byte Format

The SRQ mode command controls which conditions within the instrument will generate an SRQ (Service Request). Once an SRQ has been generated, the status byte can be checked to determine if the SRQ was generated by the Model 220 or 230. In addition, other bits in the status byte are set depending on certain data and error conditions.

The instrument may be programmed to generate an SRQ under one or more of the following conditions:

1. If the instrument receives an Illegal Device Dependent Command (IDDC) or Illegal Device Dependent Command Option (IDDCO), or if the instrument is not in remote when programmed.
2. If the instrument is over voltage limit (Model 220) or over current limit (Model 230).
3. If the end of the buffer (program memory) is encountered when running a program.
4. When the end of the present programmed dwell time is reached during program execution.
5. If any change occurs on the I/O port input lines.

Upon power-up, or after a DCL or SDC, SRQ is disabled.

Status Byte Format-The status byte contains information relating to data and error conditions within the instrument. The controller obtains the status byte by using the serial polling sequence described in paragraph 4.2.8. Once the byte resides in the computer, the information in Figure 4.3 can be used when interpreting data and error conditions.

SRQ Mask-In order to facilitate SRQ programming, the Models 220 and 230 make use of a mask when generating an SRQ. When the appropriate bit in the mask is set, the instrument will generate an SRQ when those particular conditions exist. Figure 4-2 shows the format of the SRQ mask byte. Bits within the mask can be controlled by sending the ASCII character "M" followed by a decimal number from 0 to 31. Table 4-7 lists the conditions that will cause an SRQ for each command parameter. Note that the instrument can be programmed for one or more conditions simultaneously.

Bit 6 is the SRQ bit. If this bit is set, the service request was made by the Model 220 or 230. Bit 5 determines the meaning of bits 0 through 3. If bit 5 is set, the error conditions listed in Table 4-8 apply to bits 0 through 3. If bit 5 is cleared, the data conditions listed in the table apply.

Table 4-7. SRQ Commands and Conditions

SRQ Command	Conditions*				
	I/O Port Change	End Of Dwell Time	End Of Buffer	Over Limit	IDDC, No Remote
M0**					
M1					X
M2				X	
M3				X	X
M4			X		
M5			X		X
M6			X	X	
M7			X	X	X
M8		X			
M9		X			X
M10		X		X	
M11		X		X	X
M12		X	X		
M13		X	X		X
M14		X	X	X	
M15		X	X	X	X
M16	X				
M17	X				X
M18	X			X	
M19	X			X	X
M20	X		X		
M21	X		X		X
M22	X		X	X	
M23	X		X	X	X
M24	X	X			
M25	X	X			X
M26	X	X		X	
M27	X	X		X	X
M28	X	X	X		
M29	X	X	X		X
M30	X	X	X	X	
M31	X	X	X	X	X

*Indicates those conditions that will generate SRQ.

**M0 disables SRQ.

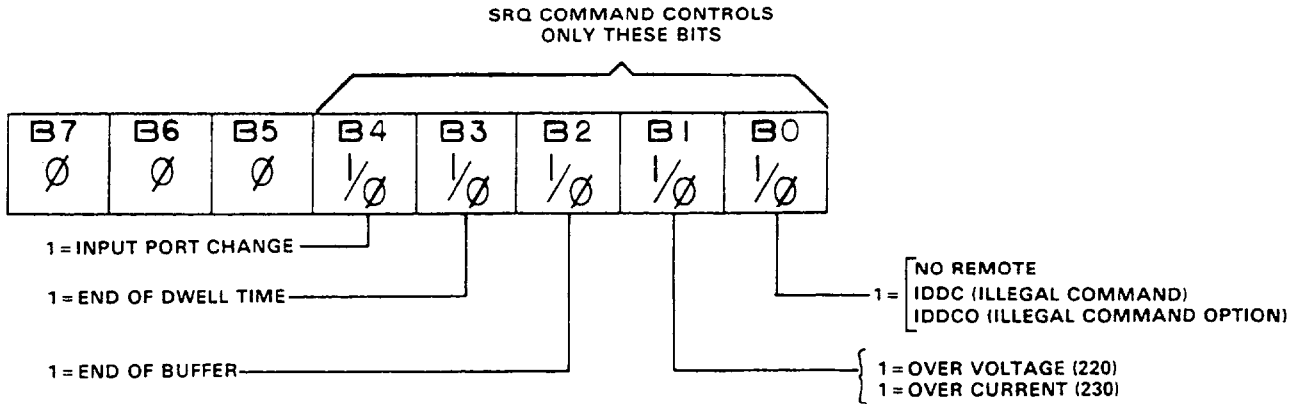
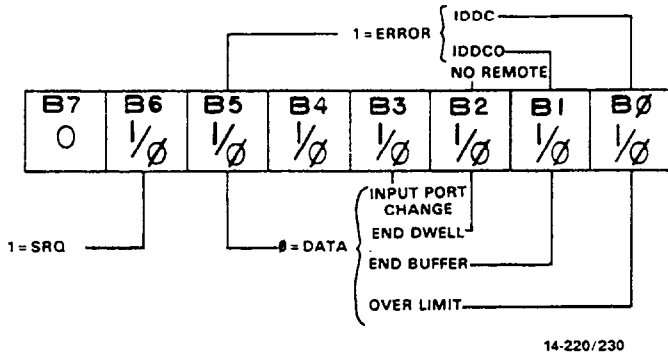

Figure 4-2. SRQ Mask Format

13-220/230

NOTE

Once the Model 220/230 generates an SRQ, the status byte should be read to clear the SRQ line. Otherwise the instrument will continuously assert SRQ.



14-220/230

Figure 4-3. Status Byte Format

Programming Example-Momentarily power down the instrument. Using the front panel controls, program a voltage and current into memory location one; enter the program below into the HP-85.

PROGRAM	COMMENTS
10 REMOTE 712 @ CLEAR	Set up for remote operation. Clear CRT.
20 OUTPUT 712; "B1L1W10T2X"	Program 10 second dwell time; start on GET trigger mode.
30 OUTPUT 712; "M8X"	Program for SRQ at end of dwell time.
40 TRIGGER 712	Trigger to start instrument.
50 STATUS 7, 2; S	Check HP-85 interface status.
60 IF BIT (S,5) = 0 THEN 50	SRQ received yet?
70 DISP "END OF DWELL TIME" @ BEEP	End of dwell time reached.
80 S = SPOLL (712)	Conduct serial poll.
90 DISP "B7 B6 B5 B4 B3 B2 B1 B0"	
100 FOR I = 7 TO 0 STEP -1	Loop eight times.
110 DISP BIT (S,I);	Display status byte bits.
120 NEXT I	
130 DISP	
140 END	

Table 4-8. Status Byte Data and Error Conditions

Bit	Error Conditions (Bit 5 = 1)	Data Conditions (Bit 5 = 0)
0	IDDC (Illegal Command)	Over Voltage (220), Current (230) Limit
1	IDDCO (Illegal Command Option)	End of Buffer
2	No Remote	End of Dwell Time
3	None	Input Port Change

After entering the program, press the HP-85 RUN key; observe that the Model 220 or 230 START/STOP light comes on. After about 10 seconds, the instrument reaches the end of the programmed dwell time and sends an SRQ. The computer then conducts a serial poll and displays the status byte bits in the proper order on the CRT.

4.3.9 Program Mode (P)

The program commands control the way the Model 220 or 230 cycles through its buffer. These commands perform the same operations as the front panel PROGRAM MODE buttons. The operation of each mode is described as follows:

1. Single-The instrument will cycle through the buffer once until it encounters a dwell time of zero in one of the memory locations and then stops.
2. Continuous-The instrument will cycle continuously through the buffer until triggered to stop. When a dwell time of zero is encountered, the instrument will go back to the first memory location and repeat the cycle.
3. Step-The instrument will increment the memory location pointer once each time a trigger stimulus is received. The trigger may come from the front panel START/STOP button, or it may come from a bus command, or through the external trigger input, depending on the selected trigger mode. If a dwell time of zero is encountered, the instrument will cycle back to the next memory location with the next trigger stimulus.

The bus commands that control the program mode are:

- P0 Single
- P1 Continuous
- P2 Step

Upon power-up, or after receiving a DCL or SDC command, the P2 mode is enabled.

Programming Example-Depress the front panel STEP button and enter the following statements into the HP-85 keyboard:

```
REMOTE 712 (END LINE)
OUTPUT 712; "POX" (END LINE)
```

When END LINE is pressed the second time, the instrument changes to the single program mode as indicated by the SINGLE light on the front panel.

4.3.10 Range (R)

The range commands set the maximum allowable current (220) or voltage (230) that may be programmed into the instrument, as described in Table 4-9.

Upon power-up, or after a DCL or SDC, the R0 mode is enabled.

NOTES:

1. The range commands do not affect a source value already stored in a memory location; range commands affect only new source commands which have yet to be programmed.
2. On a given range, the source command parameter can be no larger than that range will allow.
3. If an under range source command is given, a zero source value will be stored.
4. If an over range source command is given, the instrument will respond with a front panel IDDCO (Illegal Device-Dependent Command Option) error as described in paragraph 4.4 The instrument may also be programmed to generate an SRQ under these conditions. (See paragraph 4.3.8).
5. Settling time is less than 3ms to within 0.1% of programmed range change.
6. A range change takes up 2ms of programmed dwell time.

Table 4-9. Range Commands

Range Command	Model 220 Current Source			Model 230 Voltage Source		
	Range	Maximum Output	Minimum Step	Range	Maximum Output	Minimum Step
R0	Auto	± 101mA	500fA	Auto	± 101V	50µV
R1	1nA	± 1.9995nA	500fA	100mV	± 199.95mV	50µV
R2	10nA	± 19.995nA	5pA	1V	± 1.9995V	500µV
R3	100nA	± 199.95nA	50pA	10V	± 19.995V	5mV
R4	1µA	± 1.9995µA	500pA	100V	± 101V	50mV
R5	10µA	± 19.995µA	5nA	*		
R6	100µA	± 199.95µA	50nA	*		
R7	1mA	± 1.9995mA	500nA	*		
R8	10mA	± 19.995mA	5µA	*		
R9	100mA	± 101mA	50µA	*		

*Illegal Ranges

Programming Example-Enter the following program into the HP-85. Note that lines 40 and 70 appear twice; use only the correct line for the instrument to be programmed. The first line in each case is for use with the Model 220 current source, while the second line should be used with the Model 230 voltage source.

PROGRAM	COMMENTS
10 REMOTE 712 @ CLEAR	Set up for remote operation
20 CLEAR 712	Return to default conditions.
30 OUTPUT 712; "R3M1X"	Set instrument to R3 range. Turn on SRQ.
40* OUTPUT 712; "I100E-9X"	Program 220 for 100nA current.
40** OUTPUT 712; "V10X"	Program 230 for 10V output.
50 DISP "PRESS 'CONT'"	
60 PAUSE	Wait
70* OUTPUT 712; "I100E-6X"	Attempt to program illegal current (220).
70** OUTPUT 712; "V35X"	Attempt to program illegal voltage (230).
80 S = SPOLL (712)	Obtain status byte.
90 IF BIT (S,5) AND BIT (S,1) THEN DISP "ILLEGAL COMMAND OPTION"	Check for IDDCO
100 OUTPUT 712; "R0X"	Set to auto range.
110 END	

* Use for Model 220 current source.
 ** Use for Model 230 voltage source.

After entering the program, depress the HP-85 RUN key. The program sets the Model 220 to the 100nA range; it sets the Model 230 to the 10V range. After the computer pauses, use the front panel controls of the instrument to verify that the current or voltage has actually been stored. Then press the HP-85 CONT key and observe that the instrument displays the "IDDCO" front panel error message. The illegal command message is also displayed on the CRT because the status byte was checked by the computer; when the error and IDDCO bits were set, the computer displayed the message.

It is important to note that the commands in line 70 would be valid if the instrument were set to proper range. This is taken care of automatically in the R0 mode, since the instrument changes to the appropriate range, depending on the commanded value. To demonstrate this point, delete line 30 from the above program and run it again. This time, the commands in line 70 are accepted by the instrument since it remains in the auto range mode.

4.3.11 Trigger Mode (T)

The trigger mode commands control the stimulus to be used to start or stop Model 220 or 230 program operation. Basically, the trigger stimulus controls instrument operation much like the front panel START/STOP button does, except that the trigger stimulus can control either start or stop (not both), depending on the selected trigger mode.

Model 220 and 230 trigger modes include:

- T0 Start On Talk
- T1 Stop On Talk
- T2 Start On GET
- T3 Stop On GET
- T4 Start On X
- T5 Stop On X
- T6 Start On External
- T7 Stop On External

Upon power-up, or after receiving a DCL or SDC, the T6 mode is enabled.

In the T0 and T1 modes, the trigger stimulus is the talk command. In the T2 and T3 modes, the GET command performs triggering. In T4 and T5 modes, the execute (X) character triggers the instrument, while a trigger pulse applied to the trigger input on the rear panel of the instrument is used in the T6 and T7 modes.

NOTES:

1. When the instrument is triggered to start, program execution begins at the next higher display memory location; the display pointer is not automatically set to one by a trigger stimulus.
2. In the STEP program mode, the instrument will advance one memory location with each trigger stimulus.
3. In any of the stop trigger modes, the instrument will cease program operation immediately upon receipt of the trigger.

Programming Example-Using the front panel controls, enter a voltage and current into memory location one, and enter the following statements into the HP-85 keyboard:

```
REMOTE 712 (END LINE)
OUTPUT 712; "T0X" (END LINE)
```

This last statement places the instrument in the Start On Talk trigger mode.

Using front panel controls, place the instrument in the CONTINUOUS program mode and see that the front panel START/STOP indicator is off. Enter the following statement into the HP-85 keyboard:

```
ENTER 712; A$ (END LINE)
```

When the END LINE key is pressed, the instrument is triggered to start program operation; the front panel START/STOP light will turn on. In this example, the necessary talk command is provided by the ENTER statement.

The trigger mode may be changed by entering the following statement into the HP-85:

```
OUTPUT 712; "T1X" (END LINE)
```

The instrument will be triggered to stop program operation with another trigger as follows:

```
ENTER 712; A$ (END LINE)
```

When END LINE is pressed, the front panel START/STOP indicator turns off, indicating the instrument has received the trigger stimulus.

The operation of the instrument in other trigger modes is similar except for the trigger stimulus itself.

4.3.12 Programmable Terminator (Y)

The Model 220 or 230 uses special terminator characters to mark the end of its data string or status word. To allow a wide variety of controllers to be used, the terminator can be changed by sending the appropriate command over the bus. The default value is the commonly used carriage return, line feed (CR LF) sequence. The terminator sequence will assume this default value upon power-up or after the instrument receives a DCL or SDC.

The terminator may be programmed by sending the ASCII character Y followed by the desired terminator character. Any ASCII character except one of the following may be used:

1. Any capital letter.
2. Any number.
3. Blank
4. + - / , . or e

Special command characters will program the instrument for special terminator sequences as follows:

1. Y(LF) = CR LF (Two terminators)
2. Y(CR) = LF CR (Two terminators)
3. Y(DEL) = No terminator

NOTE

Most controllers use the CR or LF character to terminate their input sequences. Using a non-standard terminator may cause the controller to hang up unless special programming is used.

Programming Example-The terminator can be eliminated by sending an ASCII DEL with the following HP-85 statements:

```
REMOTE 712 (END LINE)
OUTPUT 712; "Y"; CHR$(127); "X" (END LINE)
```

When END LINE is pressed the second time, the terminator is suppressed; no terminator will be sent by the instrument when data is requested. The absence of the normal terminator may be verified by entering the following statement into the HP-85 keyboard.

```
ENTER 712; A$ (END LINE)
```

At this point, the HP-85 ceases to operate because it is waiting for the standard CR LF terminator sequence to ter-

minate the ENTER statement. The computer may be reset by holding down the SHIFT key and then pressing RESET on the keyboard. To return the instrument to the normal terminator sequence, enter the following statement into the HP-85:

```
OUTPUT 712; "Y"; CHR$(10); "X" (END LINE)
```

4.3.13 Status Word (U)

The status word commands allow access to information concerning various operating modes of the instrument, as well as the present status of input and output lines on the digital I/O port. When the correct command is given, the instrument will output the status word or I/O status the next time it is addressed to talk instead of sending its normal data string. The Model 220 and 230 status word commands are:

U0 Send normal status word. The format is the model number (220 or 230) followed by bytes representing DFGJKPRTMMY. Information concerning all modes except for SRQ is one byte in length.

U1 Send I/O status: I/O nn,nn, where nn is a number from 0-15.

Figure 4-4 shows the general format of the status word, and Figure 4-5 shows the format of I/O status information. Both examples show default values; these values will be present upon power-up or after the instrument receives a DCL or SDC. The I/O port values assume that nothing is connected to the I/O port. Table 4-10 shows I/O line conditions for returned I/O status values.

NOTES:

1. The status word or I/O status will be sent only once each time the status command is given. Once the status is read, the instrument will send the normal data string the next time it is addressed to talk.
2. SRQ status information contains two bytes. These two bytes will assume the decimal value previously set by the SRQ mode command.
3. The "I/O" prefix on the I/O status will be present only in the G0, G2, and G4 prefix modes. The prefix will not be transmitted in the G1, G3, or G5 prefix modes.
4. The returned terminator character is derived by ANDing the byte with 00001111 and then ORing the result with 00110000. For two-byte terminators, this is done with the last byte in the terminator sequence. For example, the last byte in the normal terminator sequence is a LF or ASCII 10 (00001010). Masking with 00001111 yields 00001010. ORing with 00110000 gives 00111010, which is printed out as an ASCII colon (:).
5. To make sure proper status is returned, the status word or I/O status should be read immediately after sending the command. Otherwise, instrument status may change, resulting in erroneous status information.
6. The status word should not be confused with the SRQ status byte. The status word contains a number of bytes pertaining to the various operating modes of the instrument. The status byte is a single byte that is read by using the serial polling sequence and contains information on SRQ status and error or data conditions.

7. The self-test (J) byte is set to 1 upon power-up or after receiving the J command. This byte will be set to 0 after the status word is read.
8. The Model number prefix (220 or 230) will be present on the status word only in the G0, G2, and G4 prefix modes.

Table 4-10. I/O Port Status Values

Returned Value	Input and Output Terminal Conditions*			
	Bit 3	Bit 2	Bit 1	Bit 0
00	L	L	L	L
01	L	L	L	H
02	L	L	H	L
03	L	L	H	H
04	L	H	L	L
05	L	H	L	H
06	L	H	H	L
07	L	H	H	H
08	H	L	L	L
09	H	L	L	H
10	H	L	H	L
11	H	L	H	H
12	H	H	L	L
13	H	H	L	H
14	H	H	H	L
15	H	H	H	H

*H ≅ 5V, L ≅ 0V

NOT PRESENT IN G1, G3, G5 MODES

I / O 1 5 , 0 0
 INPUT OUTPUT
 (0-15) (0-15)

16-220/230

Figure 4-5. I/O Status Format (Default Values Shown)

Programming Example-To demonstrate the basic method used to obtain the status word and I/O status, enter the following program into the HP-85:

PROGRAM	COMMENTS
10 REMOTE 712	Set up for remote operation.
20 CLEAR 712	Send SDC
30 OUTPUT 712; "U0X"	Send status word command.
40 ENTER 712; A\$	Enter status word into computer.

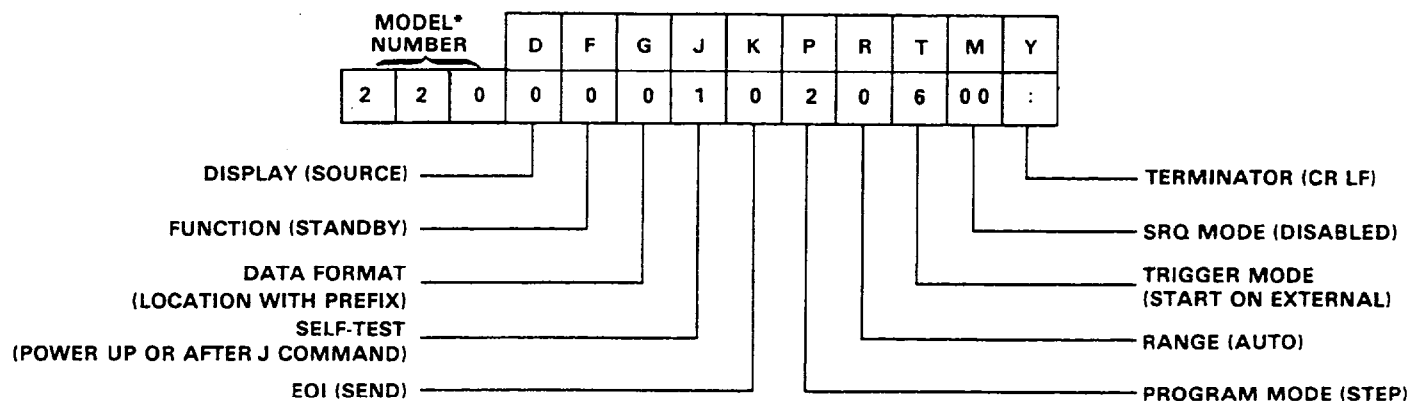

*Model number shows 230 for Model 230 voltage source.

15-220/230

Figure 4-4. Status Word Format (Default Values Shown)

50 CLEAR	Clear CRT
60 DISP "MdiDFGJKPRTMMY"	
70 DISP A\$	Display status word with model prefix.
80 OUTPUT 712;"G1U0X"	Change to G1 prefix mode. Send status word command.
90 ENTER 712; A\$	Enter status word into computer.
100 DISP "DFGJKPRTMMY"	
110 DISP A\$	Display status word without model prefix.
120 DISP	
130 OUTPUT 712; "G0U1X"	Change to G0 mode. Send I/O status command.
140 ENTER 712;A\$	Enter I/O status into computer.
150 DISP A\$	Display I/O port status with prefix on CRT.
160 OUTPUT 712; "G1U1X"	Change to G1 prefix mode. Send I/O status command.
170 ENTER 712;A\$	Enter I/O status into computer.
180 DISP A\$	Display I/O status without prefix on CRT.
190 END	

After entering the program, depress the HP-85 RUN key. The CRT will then display the status word and the I/O status both with and without prefixes. The status word will show default values because line 20 of the program sends an SDC, which sets the instrument to the default conditions.

4.3.14 Digital Self-Test (J)

The digital self-test command programs the instrument to go through many of the testing routines that are automatically performed when the instrument is first turned on. When the self-test command is sent, the following actions are performed:

1. ROM test.
2. LED test. (All front panel LEDs turn on for a short period of time).
3. The self-test (J) byte in the status word is set to 1.

The self-test command is implemented with the following command sequence: J0X

NOTES:

1. Other operating parameters and memory data are not affected by the J0 command.
2. RAM is not tested by the J0 command but is tested upon power-up.

Programming Example-Enter the program below into the HP-85.

PROGRAM	COMMENTS
10 REMOTE 712	Set up for remote operation.
20 CLEAR	Clear CRT.
30 GOSUB 100	Call status word subroutine.
40 GOSUB 100	Call status word subroutine.
50 DISP "PRESS 'CONT'"	
60 OUTPUT 712; "J0X"	Send self-test command.
70 PAUSE	Wait
80 GOSUB 100	Call status word subroutine.
90 END	
100 DISP "MdiDFGJKPRTMMY"	Begin status word subroutine.
110 OUTPUT 712;"U0X"	Send status word command.
120 ENTER 712;A\$	Read status word.
130 DISP A\$	Display status word on CRT.
140 RETURN	

After the program is entered, momentarily power down the Model 220 or 230 and wait for the normal display to return. Press the HP-85 RUN key; the computer will request the status word twice and display it on the CRT. On the first request, the self-test (J) byte is set to one because the instrument was just powered up. The second time, the J byte is set to zero because the byte was cleared the first time the status word was read.

When the program sends the J command in line 60, the Model 220/230 LEDs turn on, indicating the instrument is in the self-test mode. After the normal display returns, press the HP-85 CONT key. The program again reads and displays the status word; note that the J byte in the word was set to 1 by sending the J command.

4.4 FRONT PANEL ERROR MESSAGES

The process of programming the Model 220 or 230 involves the proper use of syntax. Syntax is defined as the orderly or systematic arrangement of programming commands or languages. The Model 220 or 230 must receive valid commands with proper syntax or it will:

1. Ignore the entire command string in which the invalid command appears.
2. Set appropriate bits in the status byte.
3. Generate an SRQ if programmed to do so.
4. Display an appropriate front panel error message.

Device-dependent commands are sent as a string of several ASCII characters. Some examples of valid command strings include:

- FOX Single command string.
- F0D1P2X Multiple command string.
- P1 X Space is ignored.

Examples of invalid command strings are:

H0X Invalid Command; H is not a command.
F5X Invalid command option; 5 is not an option of
the F command.

NOTE

If a command is sent without a numeric parameter, a zero is assumed. For example, UX is the same as U0X.

Figure 4-6 shows the front panel error messages employed by the Models 220 and 230. The messages in Figure 4-6(a) results from an Illegal Device-Dependent Command (IDDC), while the message in Figure 4-6(b) results from an Illegal Device-Dependent Command Option (IDDCO). The no remote error message in Figure 4-6 (c) results from attempting to program the instrument when it is not in the remote mode.

4.4.1 IDDC Error

An IDDC error results when the Model 220 or 230 receives an invalid command such as H1X. This command is invalid because no such letter exists in the instrument's programming language.

Programming Example-To demonstrate an IDDC error, enter the following statements into the HP-85 keyboard:

REMOTE 712 (END LINE)
OUTPUT 712; "H1X" (END LINE)

When END LINE is pressed the second time, the error message in Figure 4-6(a) is displayed for about one second.

4.4.2 IDDCO Error

An IDDCO error occurs when the numeric parameter associated with a legal command letter is invalid. For example, the command T9X has an invalid option because the instrument has no trigger mode associated with that number.

Programming Example-To demonstrate an IDDCO error, enter the following statements into the HP-85:

REMOTE 712 (END LINE)
OUTPUT 712; "T9X" (END LINE)

When END LINE is pressed the second time, the front panel error message in Figure 4-6(b) is displayed for about one second.

4.4.3 No Remote Error

A front panel no remote error message will be displayed if the Model 220/230 is not in the remote mode when it receives a command over the bus. If an attempt is made to program the instrument when it is not in the remote mode, the no remote message in Figure 4-6 (c) will be displayed on the front panel for about one second.

Programming Example-To make sure the instrument is

not in the remote mode, enter the following statement into the HP-85:

LOCAL 7 (END LINE)

Now enter the following programming statement into the keyboard:

OUTPUT 712; "G0X" (END LINE)

When this statement is executed, the no remote error message in Figure 4-6 (c) is displayed on the front panel of the instrument for about one second.

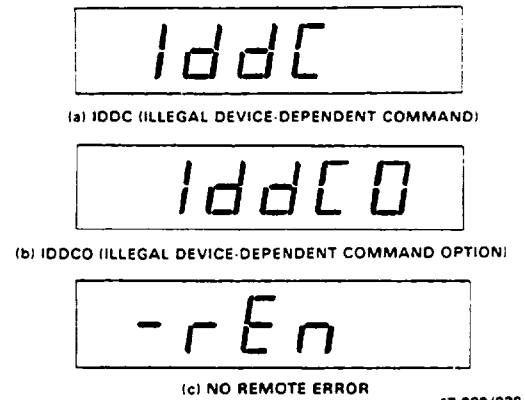

Figure 4-6. Front Panel Error Messages

4.5 WAVEFORM PROGRAMS

Because of the versatility afforded by the 100 point program memory, the Model 220/230 can be programmed to simulate many complex waveforms. Of course, no continuous mathematical function can be precisely defined with a series of discrete steps, but such approximations are adequate for many situations.

The basic method for generating waveforms involves using the controller to generate the required mathematical function and calculate the source values. Then, all 100 data points can be loaded into the instrument for execution.

CAUTION

Programming certain mathematical functions may cause numerous range changes within the Model 220/230. This could reduce the life of internal relays if such waveforms are generated for long periods of time.

4.5.1 Sine Wave Approximation

A sinusoidal approximation can be programmed by allowing the controller to generate the sine function and then calculate the source output values. Once the Model 220/230 has been programmed, the instrument will generate a fair approximation of a sine wave. The period of the waveform will depend upon the selected dwell time of each program step. Each dwell time should be identical to preserve waveform symmetry.

Programming Example-The program below generates a sine function and programs each of the 100 memory locations with appropriate source, limit, and dwell time information. For purposes of this demonstration, a 10ms dwell time has been selected. This will result in a waveform period of approximately one second. The peak output of the Model 220 is set at ± 10 mA; the peak output of the Model 230 is ± 10 V. Enter the program into the HP-85; note that the exact form of lines 10 and 90 depends on the instrument to be programmed.

PROGRAM	COMMENTS
10* A=0.01 @ V\$="V20"	Set current multiplier to 10mA peak; 20V limit.
10** A=10 @ I\$="I1"	Set voltage multiplier to 10V peak. Current limit to 20mA.
20 W\$="W10E-3" @X\$="X"	Set dwell to 10ms; define execute character.
30 DEG @ SHORT B	Short variable B; set to degree mode.
40 REMOTE 712	Set up instrument for remote operation.
50 CLEAR 712	Set to default conditions.
60 FOR I=1 TO 100	Loop 100 times.
70 B=A*SIN (360/100*I)	Multiply source multiplier constant by sine function.
80 B\$="B"&VAL\$(I)@L\$ ="L"& VAL\$(I)	Build buffer, location command strings

90* I\$="I"&VAL\$(B)	Build current command string.
90** V\$="V"&VAL\$(B)	Build voltage command string.
100 OUTPUT 712;B\$;L\$;I\$;V\$; W\$;X\$	Program memory slot I.
110 NEXT I	Next data point.
120 OUTPUT 712; "D0P1F1B1L1T4X"	Program modes; trigger to start unit.
130 END	
* Use this line for Model 220 current source.	
** Use this line for Model 230 voltage source.	

After entering the program, connect a 1k Ω load resistor across the output of the instrument and monitor the output with a suitable device, such as an oscilloscope or plotter. Press the HP-85 RUN key and observe the Model 220/230 display, which will show the source data being stored into program memory locations. Once data has been stored, the program sets the unit to the appropriate operating modes and starts program operation.

4.5.2 Ramp Simulation

Virtually any waveform may be simulated by substituting line 70 of the above program with the appropriate mathematical expression. The peak value of the expression, not including the A multiplier constant, should be no greater than ± 1 . For example, the Model 220/230 can be programmed to generate a ramp by substituting the following program line into the above program:

$$70 B = A/100*I$$

SECTION 5 IEEE COMMAND FLOW CHARTS

5.1 INTRODUCTION

This section describes what happens when the Model 220/230 receives various commands (DCL, IFC, REN, etc.) across the IEEE-488 bus. Each command is accompanied with a flow chart and a brief description of the command.

5.2 DCL (DEVICE CLEAR)

The DCL command simultaneously clears all instruments equipped to implement the command by returning them to their initialized states.

The flow chart for Model 220/230 DCL implementation is shown in Figure 5-1. At the start, the DCL command causes the 9914 GPIA to interrupt the Model 220/230's micro-processor. The programmable parameters are returned to the default conditions listed in Table 4-2. Also, program memory is cleared of data when the DCL is received by the Model 220/230; the memory pointers are set to location one.

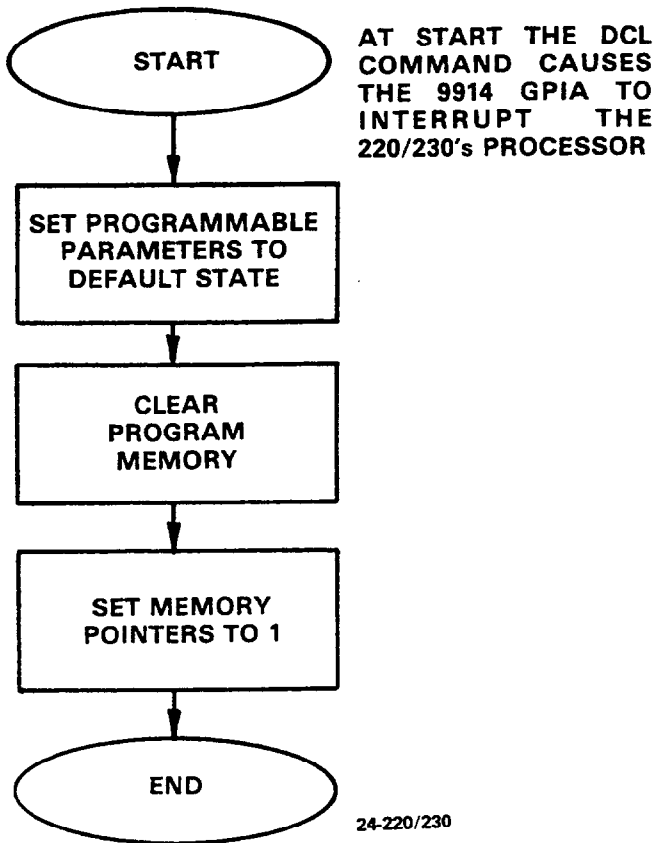

Figure 5-1. DCL Command Flow Chart

5.3 IFC (INTERFACE CLEAR)

Interface Clear simultaneously places all instruments capable of responding to an IFC command in the talk and listen idle states.

The command flow chart for the IFC command is shown in Figure 5-2. At the start, the controller asserts the IFC command by setting the IFC line low. The 9914 GPIA goes to its initialized state and the front panel TALK and LISTEN LEDs are turned off.

NOTE

The IFC command only removes the Model 220/230 from the talk or listen states. Other operating parameters are not affected.

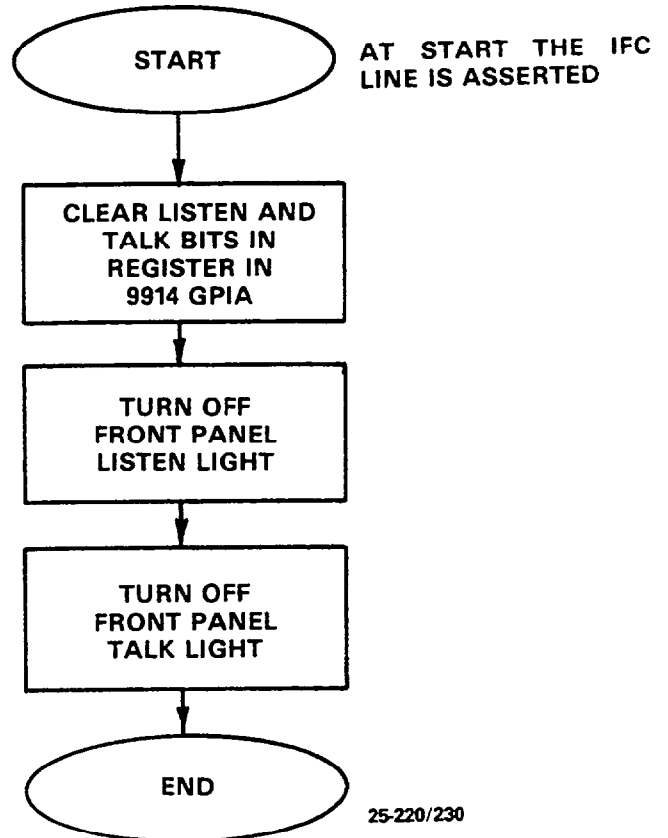

Figure 5-2. IFC Command Flow Chart

5.4 REN (REMOTE ENABLE)

Remote Enable simultaneously enables the remote programming functions of all instruments capable of responding to a REN command.

The REN command flow chart is shown in Figure 5-3. At the start, the controller asserts the REN command by setting the REN line low. The remote bit in the 9914 GPIA is set, and the front panel REMOTE indicator LED is turned on.

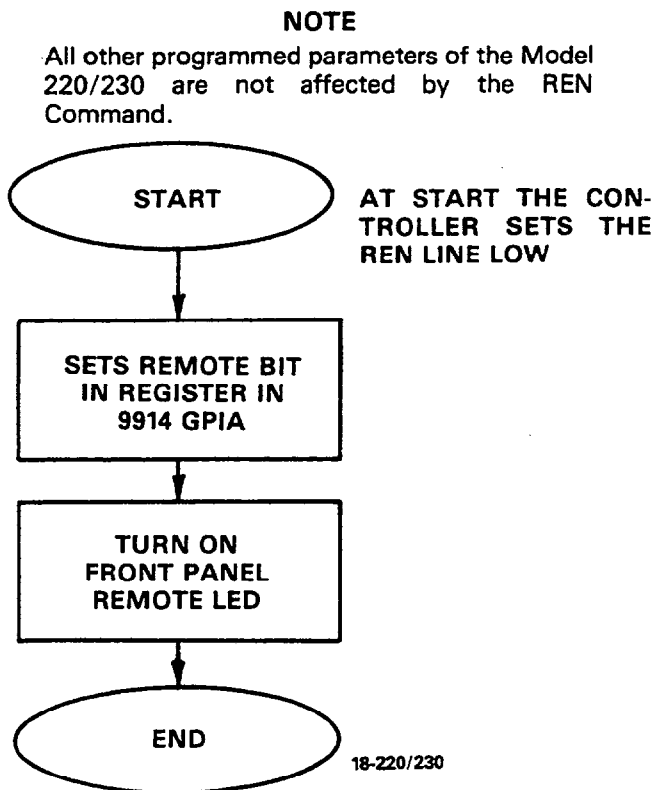

Figure 5-3. REN Command Flow Chart

5.5 SERIAL POLLING (SPE, SPD)

Serial polling is used to determine the status of instruments on the bus. To enable the serial polling sequence, the controller first places the SPE (Serial Poll Enable) command on the bus. Once the bus is in the serial poll mode, the controller addresses each instrument to talk. If an instrument is addressed in this manner when it is in the serial poll mode, it places its status byte on the bus to be read by the controller. The controller then continues addressing and collecting status from other instruments on the bus. Once all instruments are polled, the serial polling sequence is disabled with the SPD (Serial Poll Disable) command.

The command flow chart for the serial polling sequence is shown in Figure 5-4. At the start, the controller places the SPE command on the bus and addresses the Model 220/230 to talk. The Model 220/230 gets a Serial Poll Active State (SPAS) interrupt and places its status byte on the bus. The completed handshake sequence clears the SPAS interrupt; the controller then places the SPD command on the bus, and the Model 220/230 returns to the previous operation.

NOTE
The serial polling sequence does not affect other programmed parameters of the Model 220/230.

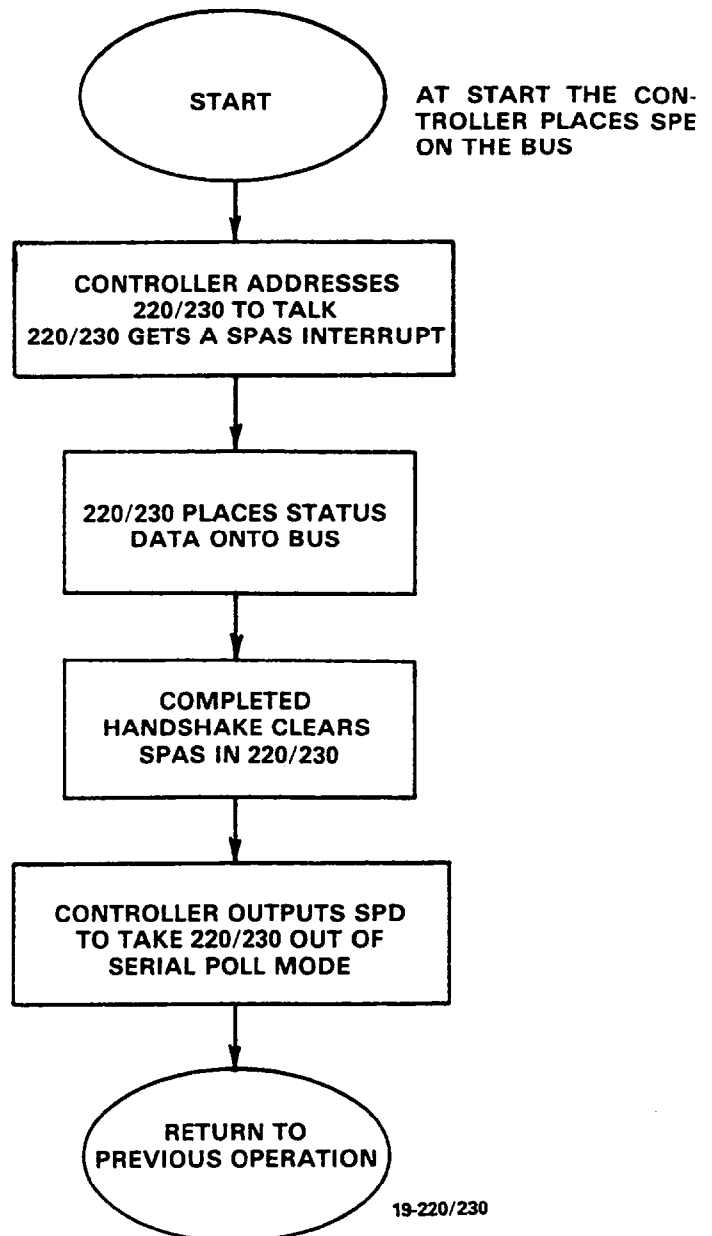

Figure 5-4. Serial Poll Flow Chart

5.6 UNL (UNLISTEN)

The UNL command simultaneously removes all previously addressed listeners from the bus.

The command flow chart for the UNL command is shown in Figure 5-5. At the start, the controller places UNL on the bus. The listen bits in the 9914 GPIA register are cleared and the front panel LISTEN LED is turned off.

NOTE

UNL only places the Model 220/230 in the listen idle state; other programmed parameters are not affected.

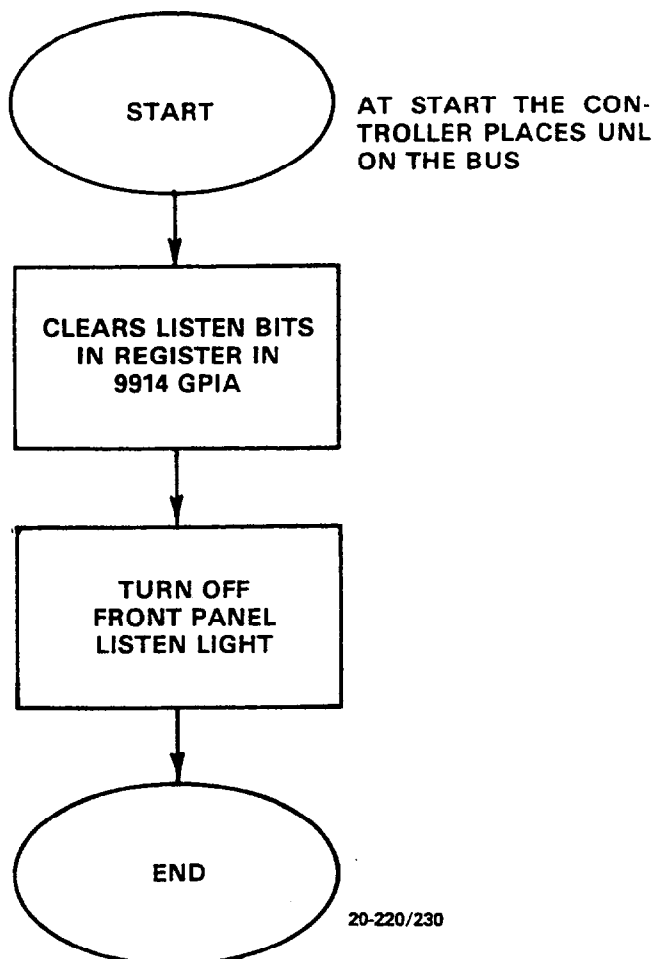

Figure 5-5. UNL Command Flow Chart

5.7 UNT (UNTALK)

The UNT command removes any previous addressed talkers from the bus.

The UNT command flow chart is shown in Figure 5-6. At the start, the controller places UNT on the bus. The talk bits in the 9914 GPIA register are cleared, and the front panel TALK LED is turned off.

NOTE

UNT only places the Model 220/230 in the talk idle state; other previously programmed parameters are not affected.

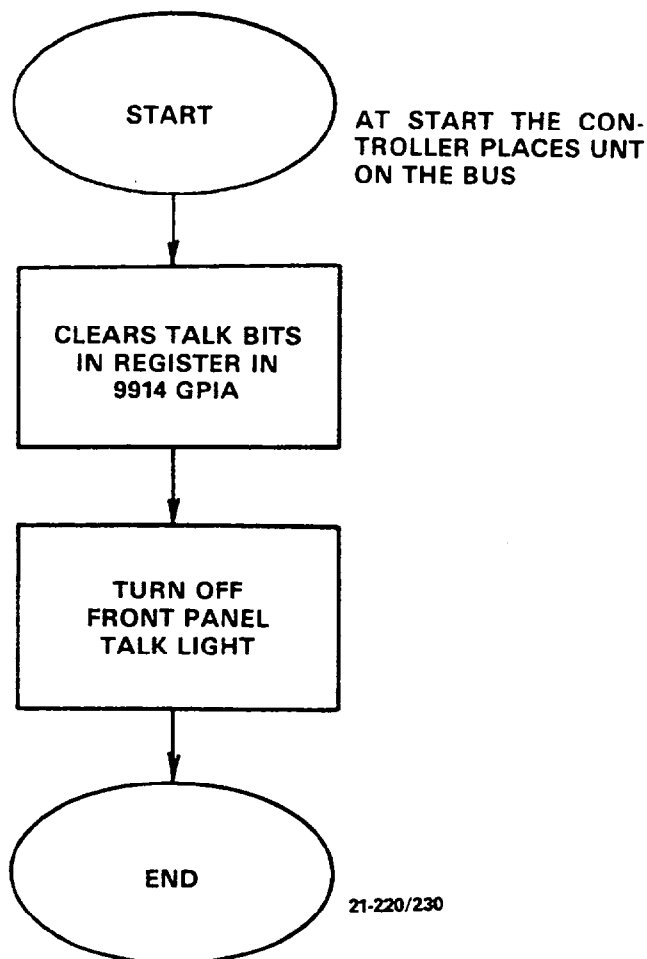

Figure 5-6. UNT Command Flow Chart

5.8 GET (GROUP EXECUTE TRIGGER)

The GET command triggers bus instruments to perform a specific operation. Using the GET command is only one of several methods that can be used to start or stop Model 220 or 230 program operation.

The GET command flow chart is shown in Figure 5-7. At the start, the controller places the GET command on the bus, causing the 9914 GPIA to interrupt the Model 220/230's microprocessor. This action causes the instrument to stop what it is currently doing and check the programmed trigger mode. If the instrument is in the T2 mode (Start On GET), program operation will begin; if the instrument is in the T3 (Stop On GET) trigger mode, program operation will cease.

NOTE

The GET command has no effect on the instrument except to trigger program operation. Other parameters are not affected by the GET command.

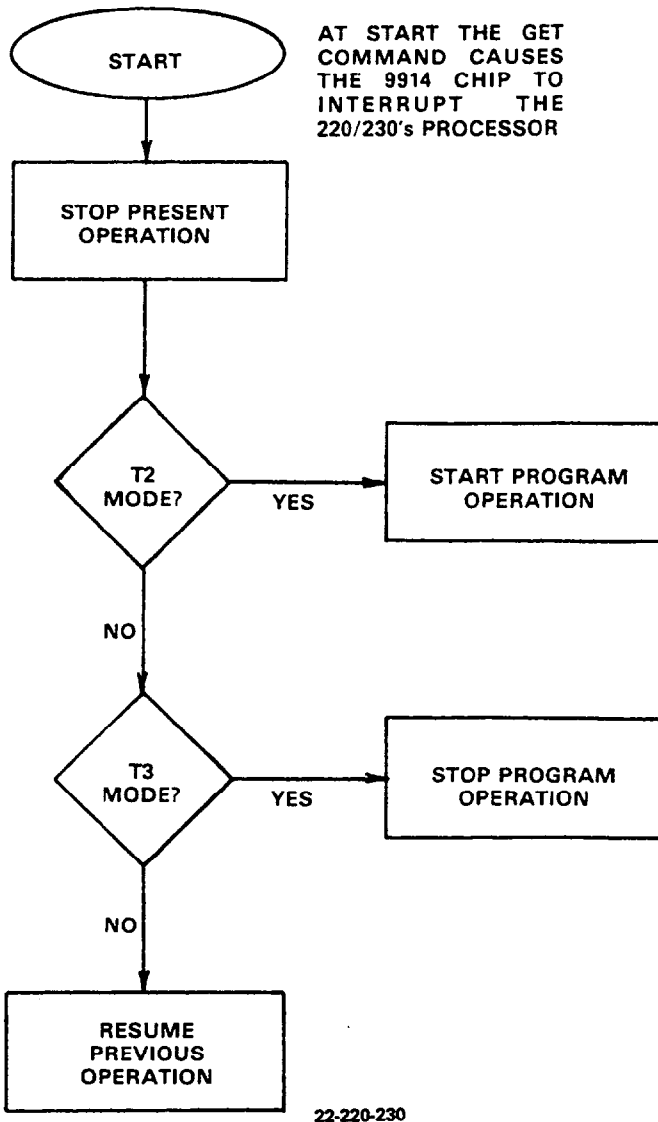

Figure 5-7. GET Command Flow Chart

5.9 GTL (GO TO LOCAL)

Go To Local takes instruments out of the remote mode of operation.

The GTL command flow chart is shown in Figure 5-8. At the start, the controller places the GTL command on the bus. This clears the remote bit in the 9914 GPIA. The front panel REMOTE indicator is then turned off.

NOTE

GTL does not restore front panel control operation of the Model 220/230. REN must be set false before front panel operation is restored once LLO (Local Lockout) is sent. Some instruments may have local operation restored with the GTL command.

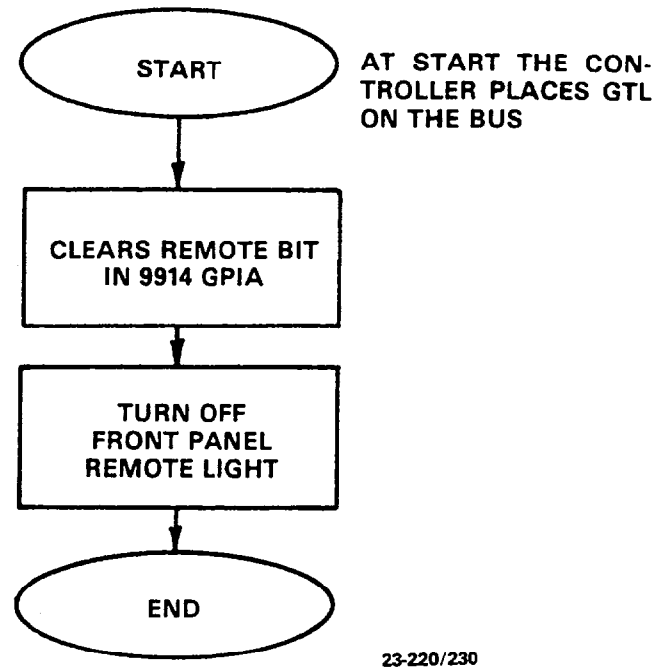

Figure 5-8. GTL Command Flow Chart

5.10 SDC (SELECTIVE DEVICE CLEAR)

Selective Device Clear affects only a single addressed instrument. Usually, instruments are returned to initialized conditions when they respond to an SDC command. The Model 220/230 will return to the default conditions listed in Table 4-2 when responding to an SDC command.

Figure 5-9 shows the command flow chart for the SDC command. At the start, the SDC command causes the 9914 GPIA to interrupt the Model 220/230's processor. The programmable parameters are then set to the default values. Also, program memory is cleared of previously stored data and display and buffer pointers are set to one.

5.11 DEVICE-DEPENDENT COMMANDS

Device-dependent commands are instrument programming commands. The purpose of the commands in this group is to program certain instrument operating parameters. Generally, these commands are sent as ASCII alpha characters usually following by numeric parameters.

Figure 5-10 shows the device-dependent command flow chart for the Model 220/230. At the start, the command causes the 9914 GPIA to interrupt the processor. If the execute (X) character is not received, the instrument returns to the previous operation without executing any commands. Once the X character is received, the machine state register is updated to agree with the temporary register, and appropriate operating modes are changed.

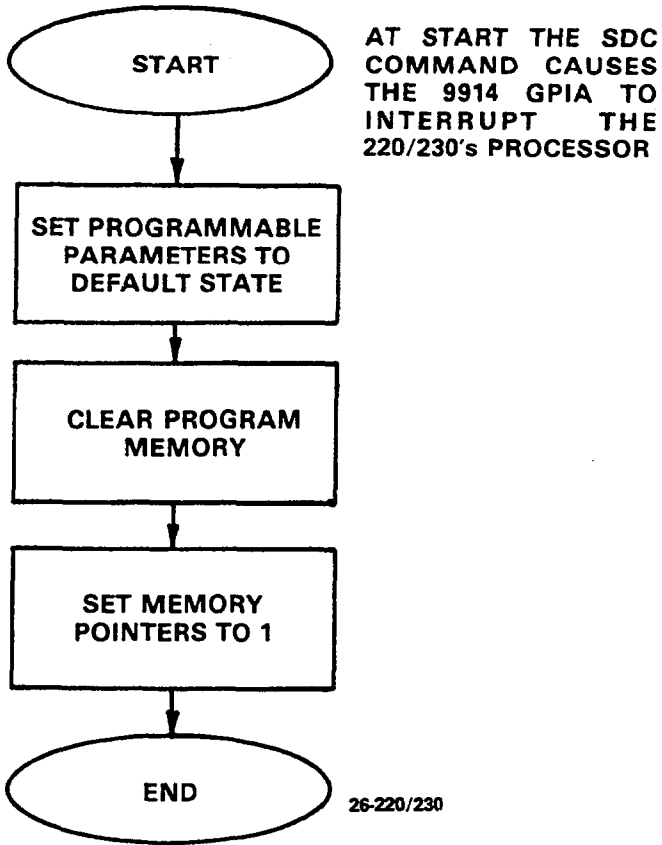

Figure 5-9. SDC Command Flow Chart

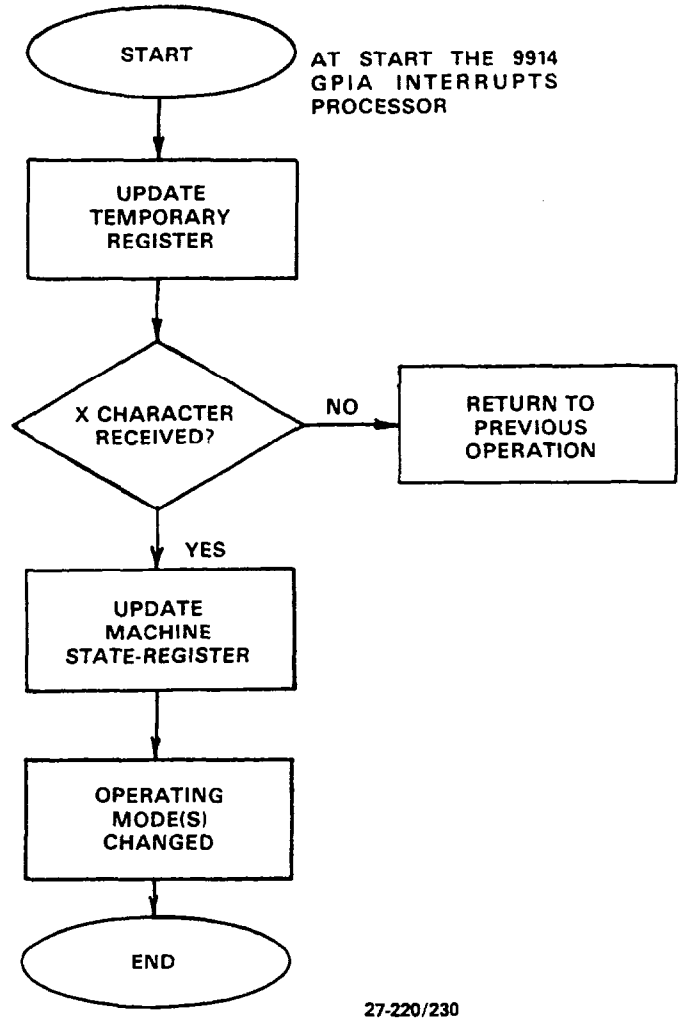

Figure 5-10. Device-Dependent Command Flow Chart



Service Form

Model No. _____ Serial No. _____ Date _____

Name and Telephone No. _____

Company _____

List all control settings, describe problem and check boxes that apply to problem. _____

- | | | |
|--------------------------------------------------|----------------------------------------------------------|--------------------------------------------------------------------|
| <input type="checkbox"/> Intermittent | <input type="checkbox"/> Analog output follows display | <input type="checkbox"/> Particular range or function bad; specify |
| <input type="checkbox"/> IEEE failure | <input type="checkbox"/> Obvious problem on power-up | <input type="checkbox"/> Batteries and fuses are OK |
| <input type="checkbox"/> Front panel operational | <input type="checkbox"/> All ranges or functions are bad | <input type="checkbox"/> Checked all cables |

Display or output (check one)

- | | |
|-----------------------------------|------------------------------------------------------|
| <input type="checkbox"/> Drifts | <input type="checkbox"/> Unable to zero |
| <input type="checkbox"/> Unstable | <input type="checkbox"/> Will not read applied input |
| <input type="checkbox"/> Overload | |

- | | |
|-------------------------------------------|--------------------------------------------------------------|
| <input type="checkbox"/> Calibration only | <input type="checkbox"/> Certificate of calibration required |
| <input type="checkbox"/> Data required | |

(attach any additional sheets as necessary)

Show a block diagram of your measurement system including all instruments connected (whether power is turned on or not). Also, describe signal source.

Where is the measurement being performed? (factory, controlled laboratory, out-of-doors, etc.)

What power line voltage is used? _____ Ambient temperature? _____ °F

Relative humidity? _____ Other? _____

Any additional information. (If special modifications have been made by the user, please describe.)

Be sure to include your name and phone number on this service form.