

OSU Manually Operated 2 Cylinder Gas Cabinet

Operations Manual

Rev 0

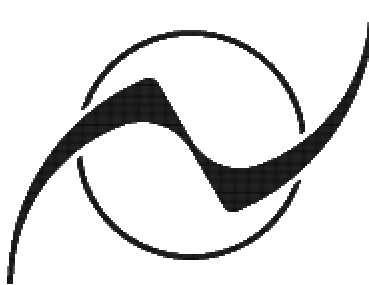

© Copyright, 2003 Process Tube Systems, Inc.

Process Tube Systems, Inc.
9025 SW Hillman Court, Suite 3132
Wilsonville, OR 97070

OSU

2 CYLINDER GAS CABINET

Table of Contents

ABOUT THIS MANUAL	3
1.0 GENERAL SYSTEM OVERVIEW	4
1.1 Purpose and Functionality	4
1.2 Standard Features	4
2.0 SYSTEM SAFETY	4
2.1 Safety Features	4-5
2.2 Safety Precautions	5
2.2.1 Personnel	5
2.2.2 Mechanical/Electrical	6
2.2.3 Installation	6
2.2.4 Equipment	6-7
2.3 Emergency Manual Off Switch (EMO) Operation	7
2.4 Lockout/Tagout	7-8
3.0 GENERAL INSTALLATION RECOMMENDATIONS	8
3.1 Equipment Unpacking and Insurance Claims	8
3.2 Personnel Training	9
3.3 Installation: Gas and Vent Lines	9
3.4 Installation: Gas Cabinet	9-10
4.0 START UP	10
4.1 Initial Start Up	10-11
4.2 Purging the Purge Cylinder CGA Connection	11
4.3 Vacuum/Purge Cycles Of Process Gas Cylinder CGA Connection	11-15
5.0 GAS CABINET OPERATION	15
5.1 Process Gas Delivery	15-16
6.0 MANUAL VALVE CONTROL	17
7.0 SYSTEM ALARMS	17
7.1 Alarm Messages	17-18
8.0 GENERAL MAINTENANCE RECOMMENDATIONS	18
9.0 MAINTENANCE PERSONNEL	19
10.0 CABINET MAINTENANCE PROCEDURES OVERVIEW	19-20
10.1 Process Cylinder Change Out Procedure	20
10.1.2 Leak Check Port Valve Operation	20
10.2 Component Change Out Procedure	20
10.3 Purge Cylinder Change Out Procedure	21
11.0 SERVICING THE GAS CABINET	21
11.1 Service Records Recommendations	21

11.2	Accessibility	21
11.3	Utilities	21
	11.3.1 Electrical	21
	11.3.2 Process Gas Line Out	21
	11.3.3 House Nitrogen Supply	21
	11.4.3 Purge Supply Out	21
12.0	WARRANTY AND SERVICE	22

OPERATION GUIDE FOR 2 CYLINDER GAS CABINET

About This Manual

Three sections comprise documentation for the OSU 2 Cylinder Gas Cabinet. This manual is the first section. The second section contains technical drawings. The third section contains cut sheets for all major components.

This manual provides a basic overview description of the OSU 2 Cylinder Gas Cabinet, an operational guide to features, step by step instructions required to operate the unit using the touch pad screen, and a description of alarm features and safety interlocks. Read this manual in its entirety before operating the Gas Cabinet.

This manual is a guide for the operation of the OSU 2 Cylinder Gas Cabinet. This manual is believed to be complete and accurate at the time of publication. If the procedures are used for purposes over and above the capabilities specified herein, confirmation of their validity and suitability should be obtained; otherwise, PTS, Inc., does not guarantee results and assumes no obligation or liability. In no event shall PTS, Inc., be liable for incidental or consequential damages in connection with the use of this manual.

1.0 GENERAL SYSTEM OVERVIEW

The OSU 2 Cylinder Gas Cabinet is an automatic process gas delivery system designed for one (Kr/F2) cylinder and one purge gas cylinder. The system delivers process gas to the tool at an operator controlled delivery pressure.

Gas Cabinet operation is a combination of manually controlled valves and a touch keypad with graphical display screen. Using the touch keypad the operator can activate system options.

The system is equipped with a series of safety interlocks designed to shut down the system or alert the operator to system malfunction. The operator is notified of alarm conditions by a visual warning light and text error messages displayed on the touch pad's graphical display screen, and a series of Alarm History screens detailing Alarm events.

1.1 Purpose and Functionality

- Manual gas delivery combined with minimal touch key initiated options.
- Vacuum/purge capability to allow cylinder change out to be accomplished without contamination by atmospheric gases or particles.
- Alarm indicators to monitor alarm conditions
- Emergency Manual Off (EMO) button provides emergency shut down capability.

1.2 Standard Features

- Meticulous construction of autogenously welded, electropolished, 316L stainless steel piping and components.
- Manifold with minimal internal volume improves purging efficiency.
- Pressure monitors upstream and down stream of process gas delivery line and purge line provide real time monitoring of operations.

2.0 SYSTEM SAFETY

2.1 Safety Features

The OSU 2 Cylinder Gas Cabinet is equipped with the following safety features:

- All primary electrical connections and electronic systems, including controller module, are isolated from all gases in a separate enclosure located on top of the gas Cabinet
- Electrical enclosure equipped with nitrogen supplied "Z" purge in accordance with Class I Division II area requirements
- An Emergency Manual Off switch (EMO), with easily identifiable yellow housing and red button, is located on the front of the electrical enclosure for local

system shutdown. (See Safety Section 2.3 for details on operation of Emergency Manual Off switch)

- Lockout/Tagout switch located on left side of electrical enclosure provides operator with a means of physically closing off the Gas Cabinet electrical connection to prevent unauthorized use. (See System Safety 2.4 for details on operation of lockout/tagout switch)
- All gas delivery lines, valves, regulators, and gauges are constructed of 316L stainless steel
- All gas fittings and connections are stainless steel VCR type
- All internal wiring and pneumatic lines are labeled with chemically resistant labeling

2.2 Safety Precautions

WARNING!

FOLLOW ALL SAFETY PRECAUTIONS TO THE LETTER!

Under no circumstances attempt to circumvent gas control equipment safety precautions.

Gas control and associated equipment are potentially hazardous and must not be used by persons that have not been formally trained.

Only by strictly adhering to all safety precautions can risk of personal injury or damage to equipment be avoided.

2.2.1 Personnel

This manual cannot replace formal training in compressed gas equipment operating principles and safety. This section is intended only as a reminder to adequately trained users that follow accepted safety practices.

Failure to follow recommended procedures may result in personal injury and equipment failure or contamination.

Personnel working with hazardous gases or contaminated components must be provided with suitable protective gear.

Should fire, release of toxic or otherwise hazardous gases, or any other potentially dangerous situations arise, press the Emergency Manual Off switch (EMO), then immediately evacuate all personnel from the location.

For the effects to the physical environment and material handling instructions for the gases used in the OSU 2 Cylinder Gas Cabinet refer to the Material Safety Data Sheets (MSDS) that should be available for review to all concerned personnel.

2.2.2 Mechanical/Electrical

Mechanical or electrical maintenance should follow lockout/tagout procedures as described in OSHA document 29 CFR 1910.147 (Control of Hazardous Energies, Lockout (Tagout) and 29 CFR 1910.331-335 (Electrical Safety-Related Work Practices) Chapter XVII (Edition 01 August 1992).

Because 120 VAC electrical power is applied to the equipment, a shock hazard exists if the electrical enclosure is entered during operation. Disconnect electrical power prior to disassembly, prior to replacement of electrical components, and prior to connecting or disconnecting wiring of the unit.

2.2.3 Installation

Only trained personnel should execute installation, operation, and maintenance of gas control equipment.

Follow all installation, operation, and maintenance instructions to the letter. Always replace all components, fasteners, labels, and other items exactly as originally installed. Do not modify any part of the system without authorization.

2.2.4 Equipment

Equipment not in adequate operating condition should be shut down immediately. Do not attempt to use equipment that is not operating properly.

Never attempt to defeat safety interlocks nor any other safety device.

Manual valve operation may override safety interlocks that would normally protect equipment and personnel during automatic valve operation. Be especially attentive when manually operating valves.

Whenever feasible close all valves before starting a maintenance procedure. If this practice is followed, accidental gas release will be minimized.

Equipment used in hazardous gas service must be purged prior to disassembly.

Vent all equipment prior to disassembly. Unexpected jet noise accompanying release of a high-pressure gas can startle co-workers and precipitate an accident.

Even though equipment may have been properly purged, trace amounts of purge gas and hazardous gases may remain. For this reason, components and piping that have been exposed to hazardous gases should be carefully labeled with the names of the gases and stored or discarded in accordance with safety ordinances and regulations.

Replacement of gas cylinders may require strenuous lifting or manipulation; if accomplished improperly, personal injury or equipment damage could result. It is the

responsibility of the user to employ safe cylinder lifting and manipulation of equipment techniques as described in NIOSH Publication 81-122.

Do not use the OSU 2 Cylinder Gas Cabinet for purposes other than which it is intended.

2.3 Emergency Manual Off Switch (EMO) Operation

The following set of instructions describe how to activate the Emergency Manual Off switch (EMO)

1. Locate EMO (yellow housing with red button) on front of electrical enclosure
2. Press red button in until it stops.
3. All pneumatic valves close
4. PLC and touch keypad remain on line

To reset EMO

1. Locate EMO (yellow housing with red button) on front of electrical enclosure
2. Turn red button left until it stops. Pull button out
3. Power is returned to Gas Cabinet and system comes on line
4. Touch screen initializes and displays Main Screen
5. Press F4 to clear the EMO alarm message
6. The Gas Cabinet is ready for use provided there are no other error alarm events

2.4 Lockout/Tagout Switch

The following instructions describe how to open and close the Lockout/Tagout switch.

To Close Lockout/Tagout switch

1. Locate Lockout/Tagout switch on upper left of electrical enclosure
2. Turn black arrow knob of switch **left** until it stops and arrow is pointing horizontal (The letter "O" is displayed on top of switch and lock holes on side of switch are exposed)

NOTE: All power to Gas Cabinet Electrical Control box is shut off. All pneumatic valves close.

3. Insert lock through switch lock holes
4. Place lock in closed position
5. Lockout/Tagout switch is now closed and secure from unauthorized use

To Open Lockout/Tagout switch

1. Locate Lockout/Tagout switch on upper side of electrical Cabinet
2. Remove lock from lockout switch
3. Turn black arrow knob of switch **right** until it stops and arrow is pointing straight up (The letter "I" is displayed on top of switch and lock holes on side of switch are covered)

4. Lockout/Tagout switch is now open and the OSU 2 Cylinder Gas Cabinet is ready for authorized use

3.0 GENERAL INSTALLATION RECOMMENDATIONS

WARNING!

TEST ALL EQUIPMENT BEFORE PLACING IN SERVICE

Operation of this equipment without prior testing, modification of this equipment, circumvention of recommended operating procedures recommended in this manual can result in injury or equipment damage.

Under no circumstances must this equipment be used for control of a hazardous gas until suitability for service has been demonstrated. PTS assumes no liability for damages resulting from equipment operation. The user is ultimately responsible for equipment integrity and safety.

Follow all installation and operation instructions to the letter; should questions arise, call a supervisor or contact the PTS Technical Service Department for advice (503.682.4080).

When working with components that contact process or purge gases always wear new latex gloves to avoid contact with toxic residues and fingerprint contamination of clean surfaces (example: face-seal connections).

Pneumatic supply tubing is best cut with a plastic tubing cutter rather than scissors or diagonal pliers. Plastic tubing cutters are available from tool distributors.

Upon disassembly, always inspect manifold face-seal connector gasket sealing surfaces for dirt, scratches, dents, pitting or corrosion. Clean or replace affected parts before assembly.

3.1 Equipment Unpacking And Insurance Claims

Exteriors of all packages should be carefully inspected on arrival as described below.

The OSU 2 Cylinder Gas Cabinet is shipped FOB the PTS factory, title to purchased goods passes to the customer upon pickup by the carrier. Damage sustained during transit accordingly is the responsibility of the carrier, with whom insurance claims for damage should be filed. Please inspect all shipping cartons immediately upon receipt. Should damage or stains be observed, immediately notify the carrier requesting that an insurance claims agent be present when the carton is opened. Should any damage be discovered, retain the carton, the contents, and all packaging materials for inspection by the insurance.

3.2 Personnel Training

Only trained personnel should operate equipment. Installation of equipment should be entrusted only to personnel that are trained and experienced in electromechanical assembly techniques and who thoroughly understand gas control equipment.

Persons that do not understand the principles of gas control equipment operation can injure themselves and co-workers. They can also damage equipment, resulting in unexpected down time and expense.

All personnel responsible for equipment installation or operation must fully understand the specific procedures to be accomplished and all associated safety requirements before installation or operation begins.

If facility personnel are not confident in their abilities to install or operate the equipment, PTS Field Service should be contacted for assistance. PTS specialists are available to assist equipment owners and provide authoritative training in all aspects of equipment installation, operation, and maintenance.

3.3 Installation: Gas and Vent Lines

All connections on all process gas, purge gas, venturi supply and vent lines outside the Gas Cabinet shall be installed in accordance with pertinent safety ordinances and regulations.

Label the equipment per federal and state OSHA standards. Specifically tag all process gas and nitrogen gas supply lines with the name and flow direction in accordance with NFPA regulations.

3.4 Installation: Gas Cabinet

The following instructions describe how to install the pneumatic and electrical inlet/outlet lines of the OSU 2 Cylinder Gas Cabinet. For electrical and assembly drawings of this system reference the Technical Drawings section of this manual.

NOTE: An approximate area of 30 inches wide x 88 inches tall is required to set the OSU 2 Cylinder Gas Cabinet in place. An additional 60 inches of clearance is necessary in front of the Cabinet for operation and maintenance access.

1. Secure Gas Cabinet using all four bolt holes located at bottom of Cabinet.

NOTE: PTS recommends through bolting (3/4-inch diameter bolts) on elevated concrete floors. For slab floor installation, fully imbed 3/4-inch wedge anchor (Hilti-Kwikset II or equal).

2. Connect ¼” process gas outlet line (welded).
3. Connect ¼” secondary purge connection at MV 11 (VCR)
4. Connect ¼” House N2 (or inert gas supply) line for Venturi supply (welded).
5. Connect ¼” N2 (or inert gas supply) inlet line to connection located on outside of electrical enclosure. (connection for pneumatic gas and enclosure purge gas). Suggested pneumatic gas supply pressure is 80 psig
6. Leak check all external piping connections to Gas Cabinet to confirm proper sealing using facility leak check procedures.
7. Connect the following electrical connections located at rear of electrical enclosure
 - a. Power to 120V/5 amp/50/60Hz power inlet (Recommended minimum wire size is 14 gauge)
 - b. Remote Low Cyl Alarm interface
 - c. Remote Life Safety
 - d. Remote General Alarm interface
9. Connect process gas pigtail connection to process gas cylinder.
10. Set Switch Gauge, PSW02, to pressure that will indicate when process cylinder is low.
11. Connect 580 CGA pigtail connection to He purge gas cylinder.
12. Set Switch Gauge, PSW01, to pressure that will indicate when purge cylinder is low.

NOTE: After connecting process gas cylinder a leak check of the fitting is required. However, it is necessary to complete the Initial Start Up procedure first (see section 4.1).

4.0. START UP

The following set of instructions describe initial start up of the 2 Cylinder Gas Cabinet as well as required steps to power up the system. The steps are:

- Initial Start Up
- Purging the Purge Cylinder CGA Connection
- Vacuum/Purge Cycles of the Process Gas Cylinder CGA Connection
- Leak Check Process Gas Cylinder CGA Connection.
- Purge to Tool (optional)

WARNING: All required installation connections must be in place and functional before start up operation of the Gas Cabinet begins.

4.1 Initial Start Up (Power On)

1. Confirm all regulators are set for zero output. (Regulators turned counter clockwise and “backed all the way out.”)

2. Confirm Emergency Manual Off (EMO) switch is actuated (pushed in) to prevent system startup when power is supplied to system.
3. Confirm Lockout/Tagout switch is in the “OFF” position.
4. Confirm facilities N2 (or inert gas supply) electrical enclosure supply does not exceed 100 psig.
5. Set Gas Cabinet purge regulator pressure to 80 psig (located inside electrical enclosure).
6. Confirm power supply to Gas Cabinet functional.

120VAC / 5 amps/50-60 Hz

7. On outside front of electrical enclosure door set N2 (or inert gas supply) purge flow meter to 10 scfh. Allow to purge for 5 minutes before activating power to system.
8. Turn Lockout/Tagout switch to “ON” position.
9. Gas Cabinet is now ready to power up.
10. Pull out red EMO switch knob located on right side of electrical enclosure.
11. System powers up.

4.2 Purging the Purge Cylinder CGA Connection

1. Confirm Purge Gas Cylinder connected to purge CGA fitting and cylinder valve closed. Close MV02 and MV03.
2. Open Purge Gas Cylinder Valve. Open MV01 slightly for a minimum of 10 seconds to purge CGA connection. Then close MV01.

DANGER

Opening MV01 results in high pressure gas release. Do not open MV01 suddenly. Protect ears and eyes. Do Not Place Hands, Feet or Body beneath MV01.

4.3 Vacuum/Purge Cycles of Process Gas Cylinder CGA Connection

Step 1 The Vacuum Cycle

1. Confirm process cylinder valve connected to CGA fitting and cylinder valve closed
2. Confirm AV01 and AV02 are closed. If open, Press F3 on Keypad to close.
3. Open process gas regulator (R02) turning handle clockwise.

NOTE: Open regulator about half way

DANGER

DO NOT OPEN PROCESS CYLINDER VALVE

4. Close manual valves MV01, MV02, MV03, MV04, MV05, MV07, MV09, MV11
5. Open MV10, MV08, MV06

NOTE: It is suggested to open MV10 first to begin the vacuuming of the manifold. MV10 controls the vacuum supply from the Facility.

WARNING

Always confirm that **VACUUM VENTURI** supply is operational before performing any maintenance functions

6. After placing the manual valves in their correct position use the touch pad on the electrical enclosure to begin the vacuum process
 - a. On the Electrical Enclosure Press F3 of the key pad (PURGE ON/OFF) to initiate the vacuum cycle. Valves AV01 and AV02 open and the function screen readout displays:

Purge Gas On
Process Gas On

Confirm that valves AV01 and AV02 are open. The valve “winkers” will have a green dot when open and appear black when closed.

- b. The system is now under vacuum. Vacuum duration is determined by the Facility.
- c. To end the vacuum cycle close manual valves MV06, MV8 and MV10 and press F3 to close Valves AV01 and AV02. The function screen readout displays:

Purge Gas Off
Process Gas Off

Refer to the chart below for Valve settings during the Vacuum portion of the Vacuum/Purge Cycle.

Process Cylinder Change Out Vacuum Cycle Valve Sequence

Valve Type	Valve Name	Valve Status	
		Open	Closed
Manual Valves	MV01		X
	MV02		X
	MV03		X
	MV04		X
	MV05		X
	MV06	X	
	MV07		X
	MV08	X	
	MV09		X
	MV10	X	
	MV11		X
Air Actuated Valves	AV01	X	
	AV02	X	

Step 2 The Purge Cycle

1. Confirm process cylinder valve closed
2. Confirm AV01 and AV02 closed. If open, Press F3 on Keypad to close.
3. Confirm process gas regulator (R02) set to allow delivery of process gas
4. Close manual valves MV11, MV10, MV09, MV08, MV07, MV05, MV01
5. Confirm purge regulator set for zero “0” gas flow output. Turn regulator handle counter clockwise until “backed all the way out.
6. Open MV02, MV03, MV04, MV06
7. Open Purge Cylinder Valve. Set purge regulator delivery pressure.

NOTE: Never set the purge gas delivery pressure (gauge PI01) above the maximum gauge reading of the process gas delivery gauge (PI02) or process cylinder pressure switch gauge (PSW02).

8. Press F3 on the key pad (PURGE ON/OFF) to initiate the purge cycle for the process cylinder change out. The following message appears on screen:

Purge Gas On
Process Gas On

Valves AV01 and AV02 open. Confirm that valves AV01 and AV02 are open. The valve “winkers” will have a green dot when open and appear black when closed. The system is now under positive pressure.

9. After approximately 5 seconds, Press F3 (PURGE GAS OFF) to isolate the process cylinder. Valves AV01 and AV02 close.
10. After completing step 9, close all open manual valves.

Process Cylinder Change Out Purge Cycle Valve Sequence

Valve Type	Valve Name	Valve Status	
		Open	Closed
Manual Valves	MV01		X
	MV02	X	
	MV03	X	
	MV04	X	
	MV05		X
	MV06	X	
	MV07		X
	MV08		X
	MV09		X
	MV10		X
	MV11		X
Air Actuated Valves	AV01	X	
	AV02	X	

NOTE: Repeat the Vacuum/Purge Cycle a minimum of 10 times ending on the vacuum cycle. During a process cylinder change out after a production run the Vacuum/Purge Cycle is typically repeated 25-30 times. Refer to your facilities requirements for this procedure.

DANGER

DO NOT OPEN PROCESS CYLINDER VALVE AT ANY TIME DURING THE PROCESS CYLINDER CHANGE PROCEDURE

Step 3: Leak Check Process Gas Cylinder CGA Connection

1. Close all manual valves MV01, MV02, MV03, MV04, MV05, MV08, MV09, MV10, MV11
2. Connect Leak Detector to Leak Check Port (MV07).
3. Open MV06, MV07
4. Open AV02. Press F2.
5. Leak check connection using facilities standard operating procedures
6. Close MV06, MV07.
7. Close AV02. Press F2.
8. Disconnect Leak Detector.

After completing the leak check of the process gas cylinder, the Gas Cabinet is ready for operation. See section 10.2.1 for leak check port valve operation.

Step 4: Purge To Tool (Optional)

To purge the gas delivery lines all the way to the tool complete the following steps.

1. Confirm process cylinder valve closed
2. Confirm AV01 and AV02 closed. If open, Press F3 on Keypad to close.
3. Confirm process gas regulator (R02) set to allow delivery of process gas
4. Close manual valves MV11, MV10, MV08, MV07, MV05, MV01
5. Confirm purge regulator set for gas flow output
6. Open MV02, MV03, MV04, MV06, MV09
7. Open Purge Cylinder Valve. Set purge regulator delivery pressure.

NOTE: Never set the purge gas delivery pressure above the maximum pressure capability of the process gas delivery gauge (PI02) or process cylinder pressure switch gauge (PSW02).

8. Press F3 on the key pad (PURGE ON/OFF) to initiate the purge cycle.
The following message appears on screen:

Purge Gas On
Process Gas On

Valves AV01 and AV02 open. Confirm that valves AV01 and AV02 are open. The system is now purging to the tool. The valve “winkers” will have a green dot when open and appear black when closed. To discontinue purge to tool Press F3 (PURGE GAS OFF). Valves AV01 and AV02 close.

9. Close all manual valves.

Purge to Tool Valve Sequence

Valve Type	Valve Name	Valve Status	
		Open	Closed
Manual Valves	MV01		X
	MV02	X	
	MV03	X	
	MV04	X	
	MV05		X
	MV06	X	
	MV07		X
	MV08		X
	MV09	X	
	MV10		X
	MV11		X
Air Actuated Valves	AV01	X	
	AV02	X	

5.0 GAS CABINET OPERATION

Primary operation of the Gas Cabinet involves a combination of manual and automatic functions. This combination allows the operator to flow process gas or to perform maintenance functions on the Gas Cabinet.

DANGER

NEVER FLOW PROCESS GAS AND PERFORM MAINTENANCE OPERATIONS AT THE SAME TIME.

A touch pad screen enables the operator to activate Gas Cabinet functions. F2 enables process gas on (AV02). F3 enables vacuum/purge on (AV01 and AV02) for maintenance operations. F4 acknowledges alarm and resets cabinet for operation after an alarm event. F1 allows the operator to scroll quickly through active alarms.

5.1 Process Gas Delivery

The OSU Gas Cabinet delivers process gas to the tool through one process out line. Process gas delivery is a combination of manual valve adjustments, setting the regulator to control delivery pressure and activating the Process Gas On option using the function keypad. Prior to start up all manual valves should be in the closed position and the

process gas regulator set for zero output. The regulator handle will be “backed out all the way” when the regulator is set for zero output. The actual sequence of steps to follow when opening valves is shown below. A chart displays the positions of all valves during gas delivery following these step-by-step instructions.

1. Confirm the following manual valves are closed. MV01, MV02, MV03, MV04, MV05, MV07, MV08 and MV10, MV11. They remain closed during process gas delivery.
2. Confirm process gas cylinder is closed
3. Confirm process regulator (R02) is set for zero psi output.
4. Open the process gas cylinder valve.
5. On the function key pad press F2 to turn process gas on. Pressing F2 opens pneumatic valve AV02.

NOTE: During initial startup and immediately after a cylinder change the gas pressure reading on the process cylinder switch gauge (PSW02) will not be above the cylinder empty set point. The Cylinder Empty warning alarm may activate during initial process gas flow or after a process cylinder change out. If you have not already done so, preset the switch gauge to indicate the cylinder empty set point. Press F4 and F2 at the same time to clear the alarm and activate process cylinder gas flow (process cylinder and AV02 valve opened).

6. Open MV06. MV06 allows process gas flow from the pigtail to the regulator.
7. Set regulator (R02) to desired process gas delivery pressure
8. Confirm gas delivery pressure is correct by checking pressure gauge PI02.
9. Open MV09. Opening MV09 allows gas to flow from the Cabinet to the tool

Valve Settings During Process Gas Delivery

Valve Type	Valve Name	Valve Status	
		Open	Closed
Manual Valves	MV01		X
	MV02		X
	MV03		X
	MV04		X
	MV05		X
	MV06	X	
	MV07		X
	MV08		X
	MV09	X	
	MV10		X
	MV11		X
Air Actuated Valves	AV01	X	
	AV02		X

6.0 MANUAL VALVE CONTROL

All manual valves use visible indicators to designate valve operational status, either opened or closed.

7.0 SYSTEM ALARMS

There are two general alarm types: warning alarms and error alarms. Warning alarms notify the operator that the system is able to function but operates outside the limits of system parameters. Error Alarms shut down the system to prevent damage or personal injury.

Once an alarm condition is corrected, the operator must clear the alarm from the touch pad screen by pressing F4. In the case of an error alarm, process gas flow cannot restart until the alarm condition ends and the alarm message cleared.

The error alarm is activated by four (4) alarm conditions: Emergency Off, Exhaust Failure, Purge Cylinder Low and Process (Gas) Excess Flow

There are two (2) warning alarms which appear on screen, Process Cylinder Low and Loss of Electrical Purge.

Emergency Cabinet shutdown is achieved by pushing in the EMO button on the electrical cabinet or by activating the button from a remote location. When the EMO is activated all air actuated valves close and the touch screen remains powered up to enable the operator to monitor system conditions.

7.1 Alarm Messages

Below is a list of alarm messages displayed on the touch pad screen when that alarm event occurs.

Emergency Off (EMO) – This alarm is an operator controlled alarm that shuts down mechanical operation of the pneumatic valves. The alarm can be activated from a remote location or locally at the cabinet.

Exhaust Failure – detects loss of exhaust within the cabinet enclosure. All pneumatic valves close.

Process Gas Excess Flow – detects excess process gas flow on delivery manifold using EFS switch. Alarm light is red until the excess flow condition has passed, then light will shut off. When this alarm event is detected the alarm light is red and a message appears on screen.

Purge Cylinder Low - the operator sets the pressure value using the PSW01 switch gauge that indicates the N2 cylinder is low. When this alarm event is detected the alarm light is red and a message appears on screen.

Process Cylinder Low– the operator sets the pressure value using the PSW02 switch gauge that indicates the process cylinder is low. When this alarm event is detected the alarm light is red and a message appears on screen.

Loss of Enclosure Purge – indicates loss of enclosure purge inside the electrical cabinet. When this alarm event is detected the alarm light is red and a message appears on screen.

8.0 GENERAL MAINTENANCE RECOMMENDATIONS

Installation and maintenance should be executed only by personnel trained and experienced in general electromechanical assembly and repair and who thoroughly understand gas control equipment.

To minimize equipment contamination, maintenance operations should be completed as quickly as possible. Gather required tools and materials beforehand and make sure enough time is allotted for the job.

Inspect face-seal connector gasket sealing surfaces for dirt scratches, dents, pitting or corrosion. Clean or replace affected parts before assembly.

Always install new gaskets when reassembling face-seal connections.

Tighten face-seal connections exactly 1/8 turn beyond finger tight. Over tightening, can damage the connection; under tightening can cause leakage. Always wear new latex gloves to avoid contact with toxic residues on used components and fingerprint contamination on new components.

For inboard testing with a helium-mass spectrometer leak detector, leakage at any connection should not exceed 1×10^{-8} sccs. Pneumatic and chemical supply tubing is best cut with a plastic tubing cutter rather than scissors or diagonal pliers. Plastic tubing cutters are available from tool distributors.

Whenever feasible close all process gas delivery valves before starting a maintenance procedure. If this practice is followed, accidental process gas release will be minimized.

Always follow touch screen prompts to the letter.

Below is a list of safety equipment needed to perform maintenance on the OSU 2 Cylinder Gas Cabinet. Always perform maintenance on the system in a well ventilated area. Refer to manufacturer's requirements before coming in contact with process gas products.

Safety Equipment
Eye Goggles
Latex gloves
Protective Clothing certified for process gas protection

9.0 MAINTENANCE PERSONNEL

Only trained personnel should operate equipment. Maintenance of equipment should be entrusted only to personnel trained and experienced in electromechanical assembly and repair techniques.

Personnel that do not understand the principles of gas control equipment operation can injure themselves and co-workers. They can also damage equipment, resulting in unexpected down time and expense.

All personnel responsible for equipment operation or maintenance must fully understand the specific procedures to be accomplished and all associated safety requirements.

If facility personnel are not confident in their abilities to maintain or operate the equipment, Process Tube Systems, Inc. Field Service (503-682-4080) should be contacted for assistance. PTS, Inc. specialists are available to assist equipment owners and provide authoritative training in all aspects of equipment operation and maintenance.

WARNING!

IMPROPER LIFTING OF HEAVY EQUIPMENT CAN CAUSE INJURY

As the equipment is heavy, only workers trained in NIOSH-approved lifting techniques should be assigned to either installation or removal efforts.

In this way, personal injury and damage to equipment can be effectively avoided.

10.0 GAS CABINET MAINTENANCE PROCEDURES OVERVIEW

NOTE: Control of manual valves and pneumatic valves is the same for all general maintenance operations performed on the process gas delivery system. Always use manual valves to isolate the maintenance area to avoid system contamination.

NOTE: Read Section 4 in its entirety for step by step instructions of gas cabinet operation during maintenance procedures.

The following cabinet maintenance descriptions include process gas cylinder change out, process gas component change out (regulators, filters, switch gauges, etc.), and purge cylinder change out. All process cylinder and process gas component change out procedures require a series of vacuum/purge cycles. These cycles must be performed prior to, as well as, after cylinder or component replacement.

Purge cylinder change out does not use a vacuum/purge cycle to complete the purge cylinder change out procedure.

A seven step process is used to complete maintenance procedures on the process gas delivery system. These steps are:

1. Purge To Tool
2. Thoroughly Vacuum/Purge the system.
3. Using manual valves isolate the area of maintenance.
4. Perform the maintenance.
5. Vacuum/Purge the system again.
6. Leak check the system.
7. Place the system back on line.

10.1 Process Cylinder Change Out Procedure

This operation occurs when process cylinder pressure falls below the switch gauge set point (PSW02). When cylinder pressure falls below the switch gauge set point the system alarms out and it is time to change the process cylinder. This procedure requires following operations: purge to tool, vacuum cycle/purge cycle, cylinder change out, vacuum/purge cycle, and final leak check of the cylinder connection. Each vacuum/purge cycle must be repeated as many times as necessary to clean out process gas from the process gas delivery system and to clean the lines of any contamination after a process cylinder change. Typical facility vacuum purge cycle requirements are 25 –30 cycles. The steps required to complete a cylinder change out are detailed in section 4.

10.1.2 Leak Test Valve Operation

One three-way manual valve (MV07) is provided for leak testing. When in the closed position gas passes through the manual valve but the leak test port is closed. This is the position of the valve during normal operation.

When in the open position gas passes through the valve *and* to the leak detector.

10.2 Component Change Out Procedure

To change out a regulator, filter, switch gauge, etc. follow the seven basic steps used to change a process cylinder. Thoroughly Purge to Tool, Vacuum/Purge the system. Isolate the area of maintenance by closing manual and pneumatic valves. Perform the maintenance. Vacuum/Purge the system again. Leak check the system. Place the system back on line.

10.3 Purge Cylinder Change Out Procedure

The purge cylinder change out is an entirely manual operation. Listed below are the steps required to complete a purge cylinder change out.

1. Close Purge Gas Cylinder valve. Close MV02 and MV03.
2. Open MV01. Bleed off pressure. Close MV01
3. Remove and Replace Purge Gas Cylinder
4. Open Purge Gas Cylinder Valve. Open and Close MV01 briefly to purge CGA connection
5. Open MV02 and MV03.

11.0 SERVICING THE GAS CABINET

In the event, the OSU 2 Cylinder Gas Cabinet requires repairs Process Tube Systems, Inc. (503-682-4080) should be contacted for prompt and cost-effective quotes for repairs.

11.1 Service Record Recommendations

It is advised to keep thorough and complete service records for all maintenance activities on the OSU 2 Cylinder Gas Cabinet.

11.2 Accessibility

Access to fuses and other parts within the electrical enclosure is obtained by unlocking the electrical enclosure door and tilting door forward.

Access to regulators valves and other parts within the gas Cabinet is obtained by unlocking the Cabinet door, turning the door latch, and swinging the door open. At least two feet of clearance is required to accomplish this. Replacement of gas cylinders is described in section 10.1, Process Cylinder Change Out Procedure and section 10.3, Purge Cylinder Change Out Procedure.

11.3 Utilities

11.3.1 Electrical

120VAC - 50/60 HZ

11.3.2 Process Gas Line Out

¼" Line Out

11.3.3 House Nitrogen Supply

¼" Line Gas Cabinet Inlet

¼" Line Electrical Cabinet Inlet

11.3.4 Purge Supply Out

¼" Line Out

12.0 WARRANTY AND SERVICE

Process Tube Systems, Inc. (503-682-4080), the manufacturer, warrants each system to be free from defects in workmanship under normal use and service for a period of one (1) year after delivery to the original purchaser. This warranty is limited to repairing or replacing, at the manufacturer's option, any part that shall, upon examination by the manufacturer, be determined to be defective, within one (1) year of delivery. The warranty shall cover all parts and labor necessary to make repairs within that first year. All shipping costs incurred shall be paid by original purchaser.

The provisions of this warranty shall not apply to any system, which has been subject to misuse, negligence, or accident in installation or operation. This warranty is void if the equipment has been repaired, altered, or serviced in a manner not specified by the manufacturer. The original purchaser shall, upon request by the manufacturer, furnish reasonable evidence that the defect arose from causes placing the liability on the manufacturer. This warranty is expressly in lieu of any other warranties, expressed or implied. Major components manufactured by other companies bear the warranties of their manufacturers.

OSU MANUAL 2 CYLINDER GAS CABINET Drawing List

Drawing No.	Drawing Description
OS01000-001S REV 1	GAS SCHEMATIC MANUAL 2 CYLINDER CABINET
OS01000-001A REV 0	TOP ASSEMBLY MANUAL 2 CYLINDER CABINET
OS01200-001A REV 0	GAS ASSEMBLY MANUAL 2 CYLINDER CABINET
OS0100-001L REV 0	LABEL LAYOUT 2 CYLINDER CABINET
LI01000-001E REV 1 (2Total)	ELECTRICAL SCHEMATIC MANUAL 2 CYLINDER GAS CABINET
PT20300-001A REV 3 (2 Total)	CONTROLLER ASSEMBLY MANUAL 2 CYLINDER GAS CABINET

REV.	DESCRIPTION	DATE
1	DRAWN OUTPUT	10/20/92

FUSE	AMPS	VOLTS	CLASS
F1	4	250	217 5X20

- NOTE:
1. BOND ALL EXPOSED NONCURRENT-CARRYING METAL PARTS TO THE GROUNDING TERMINAL OR ENCLOSURE.
 2. UNLESS NOTED OTHERWISE CONDUCTORS TO BE 18AWG
 3. TAG ALL CONDUCTORS WITH CIRCUIT IDENTIFIER AT BOTH ENDS
 4. USE BELOW NFPA 79 WIRING COLORS:

NFPA 79 ELECTRICAL STANDARD FOR INDUSTRIAL MACHINERY 16.1.2 AND 16.1.3	
ELECTRICAL CONDUCTOR COLOR	PURPOSE
GREEN WITH OR WITHOUT ONE OR MORE YELLOW STRIPES ** 2	EQUIPMENT GROUNDING CONDUCTOR WHERE INSULATED OR COVERED
BLACK	UNGROUNDING LINE /LOAD/CONTROL CONDUCTORS AT LINE VOLTAGE
RED	UNGROUNDING AC CONTROL CONDUCTORS AT LESS THAN LINE VOLTAGE
BLUE	UNGROUNDING DC CONTROL CONDUCTORS
ORANGE	UNGROUNDING CONTROL CIRCUIT CONDUCTORS THAT MAY REMAIN ENERGIZED WHEN THE MAIN DISCONNECTING MEANS IS IN THE OFF POSITION.
WHITE OR GRAY	GROUNDING CIRCUIT CONDUCTORS
WHITE/BLUE	GROUNDING (CURRENT-CARRYING) DC CIRCUIT CONDUCTORS
WHITE/YELLOW	GROUNDING (CURRENT-CARRYING) AC CONTROL CIRCUIT CONDUCTORS THAT MAY REMAIN ENERGIZED WHEN THE MAIN DISCONNECTING MEANS IS IN THE OFF POSITION
** EXCEPTION	OTHER COLORS WHERE THE INSULATION OR COVER IS IDENTIFIED AT ALL POINTS OF ACCESS
** EXCEPTION	FOR GROUNDING CONTROL CIRCUITS, FROM THE TRANSFORMER TERMINAL TO THE GROUNDING TERMINAL ON THE CONTROL PANEL.

NOTE: CONNECT REMOTE ESTOP W/14 AWG CONDUCTORS OR NC CONTACT W/5AMP RATING FOR LIFE SAFETY. OPENING CIRCUIT REMOVES POWER TO GAS SOLENOIDS. INSTALL JUMPER IF NOT USED.

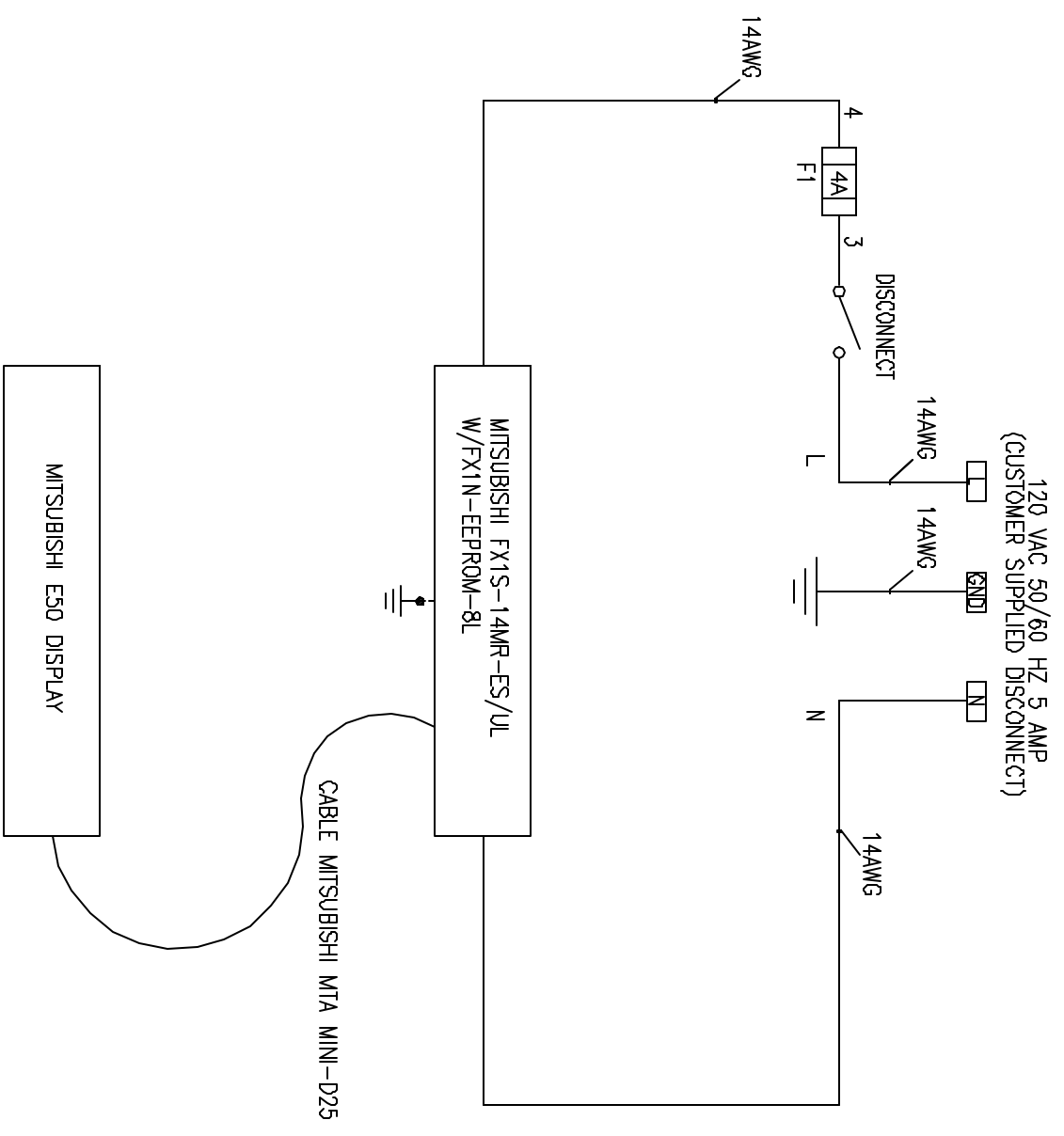
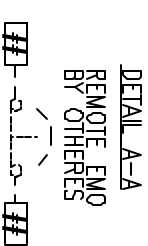

1
2
3
4
5
6
7
8
9
10
11
12
13
14
15
16
17
18
19
20

THE DOCUMENT CONTAINS CONFIDENTIAL OR PROPRIETARY INFORMATION OF PROCESS TUBE SYSTEMS INC. REVIEW THE DOCUMENT AND THE INFORMATION CONTAINED HEREIN IS TO BE REPRODUCED, COPIED, OR TRANSMITTED IN ANY MANNER WITHOUT THE WRITTEN PERMISSION OF PROCESS TUBE SYSTEMS INC. AND MUST BE RETURNED TO THE ORIGINAL SOURCE OR DESTROYED UPON THE REQUEST OF PROCESS TUBE SYSTEMS INC.

DRAWN BY: XXXX CHECKED BY: XXXX DATE: XXXX	APPROVED BY: XXXX DATE: XXXX		PROCESS TUBE SYSTEMS INC. ELECTRICAL SCHEMATIC MANUAL 2 CYLINDER CABINET SIZE: 1/8" X 11" X 11" PART NO: LD1000-001E SHEET 1 OF 2
---	---	--	---

REV.	DESCRIPTION	DATE
1	CHANGED OUTPUTS	10/05/02

REVISION BLOCK

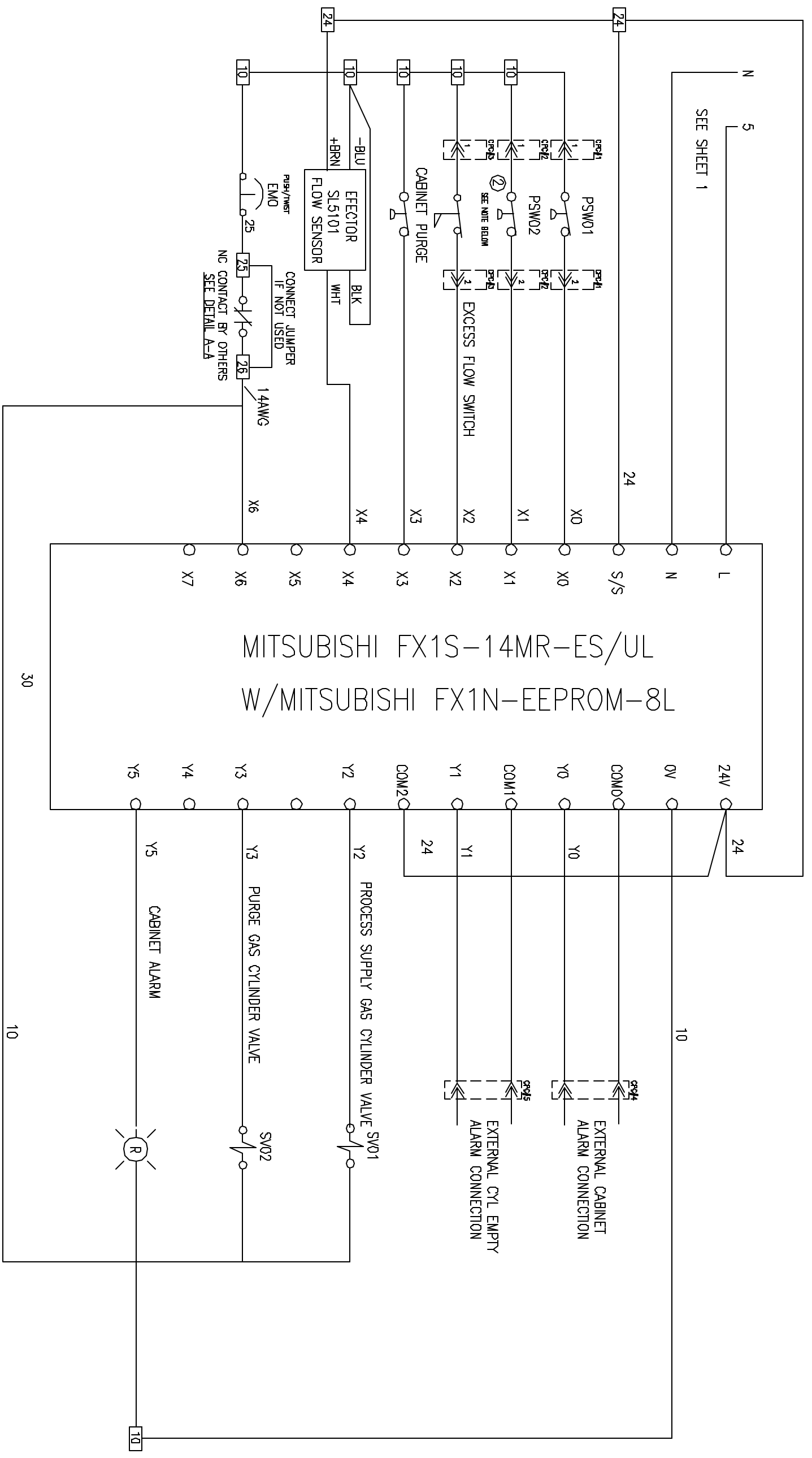

MITSUBISHI FX1S-14MR-ES/UL
W/MITSUBISHI FX1N-EEPROM-8L

NC CONTACT BY OTHERS
SEE DETAIL A-A

NOTE: 1 TOTALLY ENCLOSED DOOR SWITCH CABLE TO PASS THROUGH GROMMET IN
BOTTOM OF CONTROLLER.

2 SWAGelok SWITCH GAUGES REQUIRE THREE WIRE CONTROL. SEE DETAIL
BELOW

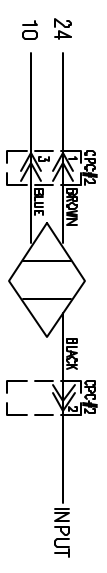

3 CONNECT ALL I/O DEVICES DIRECTLY TO PLC TERMINAL UNLESS
OTHERWISE NOTED. DO NOT USE INTERMEDIATE TERMINAL BLOCK.

NOTE: EFFECTOR FLOW SENSOR IS LOCATED IN
EXHAUST DUCTING OUTSIDE OF CONTROL
ENCLOSURE

THIS DOCUMENT CONTAINS CONFIDENTIAL INFORMATION. ANY DISCLOSURE OF THIS INFORMATION TO ANY OTHER PERSON WITHOUT THE WRITTEN PERMISSION OF PROCESS TUBE SYSTEMS INC. IS STRICTLY PROHIBITED. THIS DOCUMENT IS THE PROPERTY OF PROCESS TUBE SYSTEMS INC. AND IS NOT TO BE REPRODUCED OR TRANSMITTED IN ANY FORM OR BY ANY MEANS, ELECTRONIC OR MECHANICAL, INCLUDING PHOTOCOPYING, RECORDING, OR BY ANY INFORMATION STORAGE AND RETRIEVAL SYSTEM.	PROCESS TUBE SYSTEMS INC. 101000-001E
TITLE OF DRAWING ELECTRICAL SCHEMATIC MANUAL 2 CYLINDER CABINET	SHEET NO. 1
DRAWING NUMBER 101000-001E	DATE 10/05/02
DESIGNED BY B	CHECKED BY B
DRAWN BY B	APPROVED BY B

REV	DESCRIPTION	DATE
0	INITIAL RELEASE	11/21/02

REVISION BLOCK

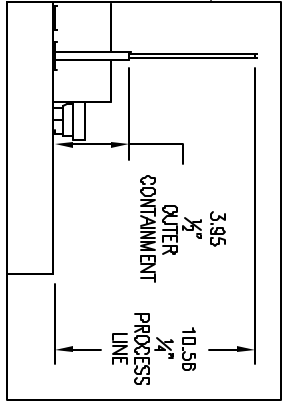

DUAL CONTAINED PROCESS OUTLET HEIGHT (BACK VIEW)

CONNECTIONS CALLED OUT ARE WHAT EXISTS ON THE CABINET

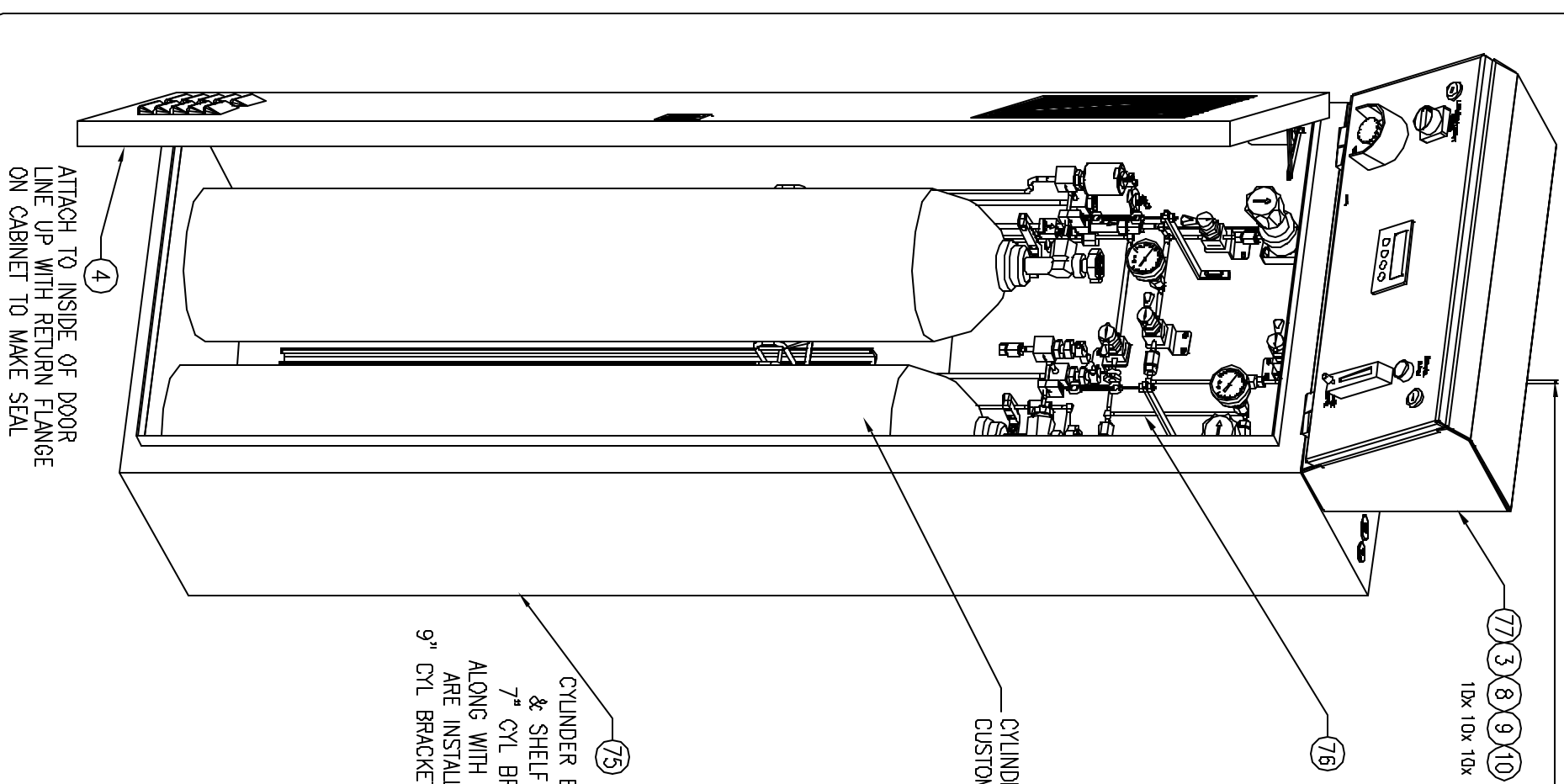
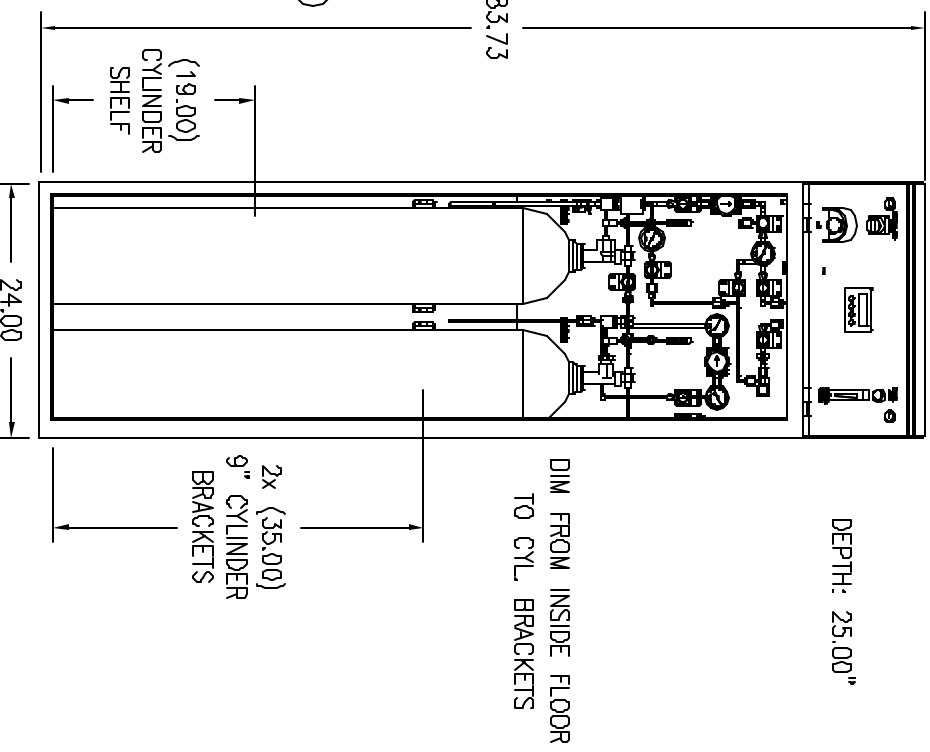

CYLINDERS ARE CUSTOMER SUPPLIED

CYLINDER BRACKETS, CHAINS & SHELF ARE INCLUDED. 7" CYL BRACKET & SHELF ARE INSTALLED ON LEFT SIDE 9" CYL BRACKET ONLY ON THE RIGHT

ATTACH TO BACK OF CONTROLLER

LIFE SAFETY-0.82
120VAC POWER INLET-2.32

6" EXHAUST DUCT 12.00

- 3.82-REMOTE LOW CYL ALARM 4 PIN CPC
- 5.57-REMOTE GEN. ALARM 4 PIN CPC
- 8.00
- 11.37-PROCESS OUTLET (1/4" INNER TUBE, 1/2" OUTER)
- 13.37-N2 VENTURI SUPPLY (1/4" FVCR)
- 20.89-VENTURI VENT (1/2" MVCR)
- 22.46-EXTERIOR PURGE LINE (1/4" FVCR)
- 23.20-N2 PURGE SUPPLY (1/4" SWAGELOK)

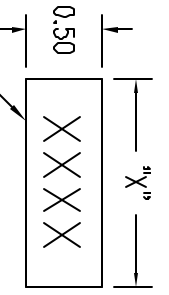

MAKE ALL LABELS WITH 1/2" TAPE W/ .25" HIGH LETTERS

ITEM	PART #	DESCRIPTION	REV	QTY
78	OS01999-001	SERIAL PLATE	D	TBD
77	PT20300-001A	ELECTRICAL ASSEMBLY	3	PTS
76	OS01200-001A	GAS ASSEMBLY	D	PTS
75	OS01101-001	CABINET MODIFICATION	D	TBD
16	9162K266	REDUCER COUPLING	MCMASTER	1
15	64575132	SPRINKLER PENDANT	MCMASTER	1
14	70706	#8 HEX NUT	FASTENAL	2
13	71057	#8 LOCK WASHER	FASTENAL	2
12	71008	#8 FLAT WASHER	FASTENAL	2
11	73724	8-32 BHSS 3/4" LING	FASTENAL	2
10	71059	#10 LOCK WASHER	FASTENAL	10
9	71009	#10 FLAT WASHER	FASTENAL	10
8	73449	10-32 SHCS 5/8" LING	FASTENAL	10
7	BPF-1/2	1/2" GROMMET PLUG	CAPILUG	1
6	NI-4-VCR-2-GR-VS	1/4" GASKET	SWAGelok	2
5	SL5101	FLOW SENSOR	EJECTOR	1
4	93085K14	5/8x3/8 D GASKET	MCMASTER	16"
3	1/8" THK FURCON 300AR	1/2" WIDE STRIP N STOCK	INDUST GASK	5.25'
2	AN931-A8-20	1/2" GROMMET (1.25 GROOVES)	SERVICE RUBBER	2
1	AN931-A4-16	1/4" GROMMET (1.00 GROOVES)	SERVICE RUBBER	2

PROCESS TUBE SYSTEMS INC.

TOP ASSEMBLY

MANUAL 2 CYLINDER CABINET

THE REMOTE CONTROLLER COMPARTMENT IS PROVIDED BY THE CUSTOMER. THE REMOTE CONTROLLER COMPARTMENT IS TO BE REPRODUCED BY THE CUSTOMER. THE REMOTE CONTROLLER COMPARTMENT IS TO BE REPRODUCED BY THE CUSTOMER. THE REMOTE CONTROLLER COMPARTMENT IS TO BE REPRODUCED BY THE CUSTOMER.

REV	DESCRIPTION	DATE
0	INITIAL RELEASE	11/21/02

REV.	REVISION BLOCK	DATE
0	INITIAL RELEASE	11/25/02

ITEM	MATERIAL (TAPE COLOR/TEXT COLOR)	TEXT	QTY
A	1/4" WIDE TAPE (WHITE/GREEN)	He	3
B	1/4" WIDE TAPE (WHITE/GREEN)	He	4
C	1/4" WIDE TAPE (BLACK/YELLOW)	Kr/F2	1
D	1/4" WIDE TAPE (BLACK/YELLOW)	Kr/F2	1

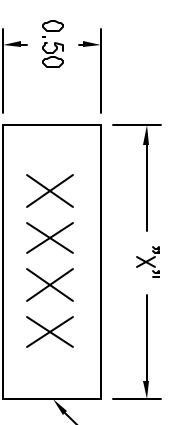
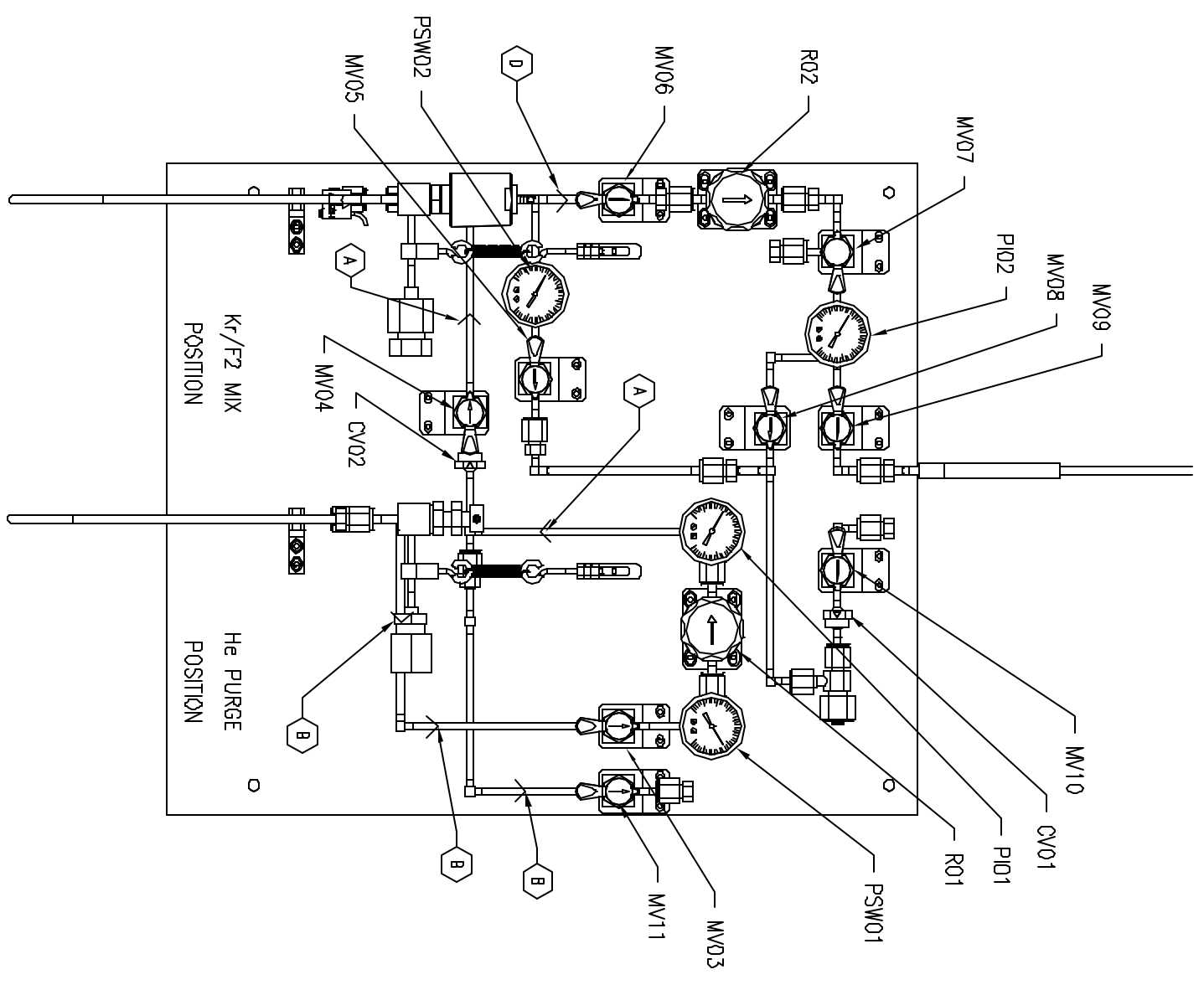
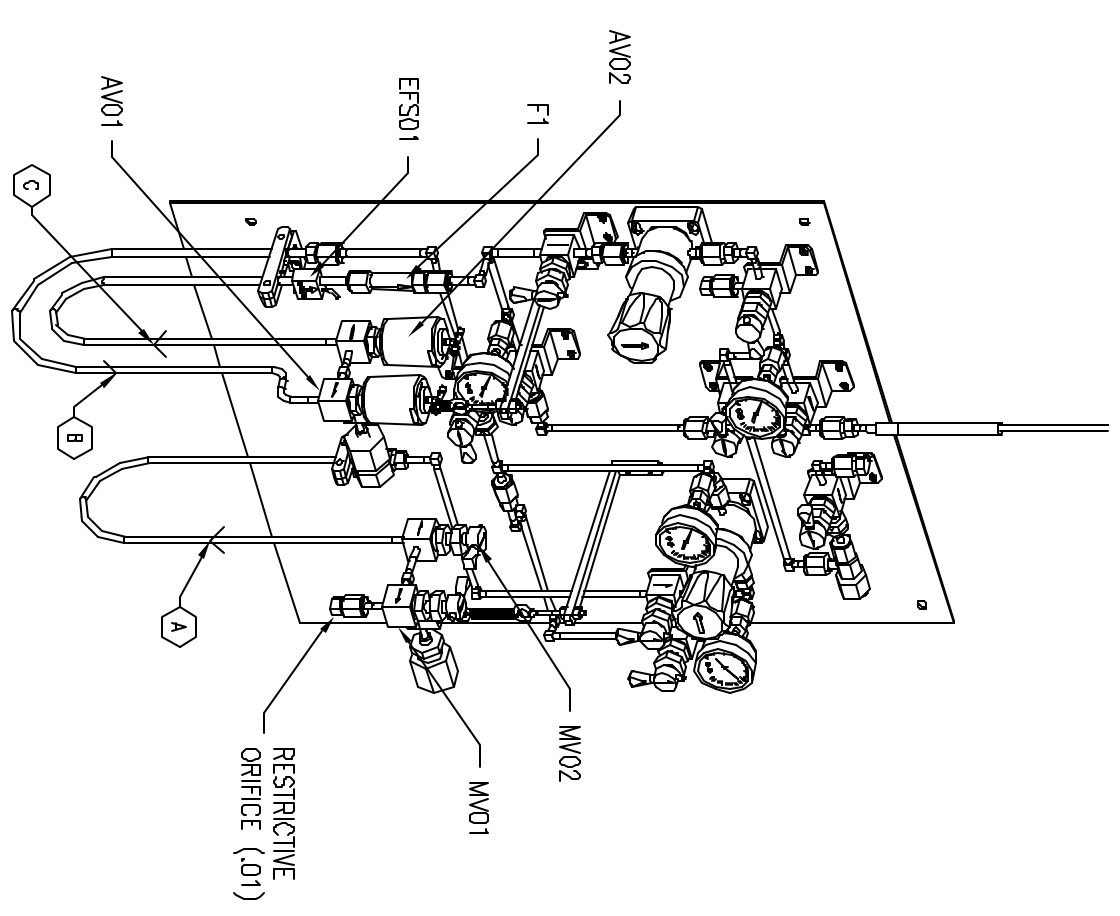

MAKE ALL LABELS WITH 1/2" TAPE W/ .25" HIGH LETTERS

THIS DOCUMENT CONTAINS CONFIDENTIAL OR PROPRIETARY INFORMATION OF PROCESS TUBE SYSTEMS INC. REPRODUCTION OF THIS DOCUMENT IS STRICTLY PROHIBITED. ANY REPRODUCTION OF THIS DOCUMENT WITHOUT THE WRITTEN PERMISSION OF PROCESS TUBE SYSTEMS INC. IS STRICTLY PROHIBITED. ANY REPRODUCTION OF THIS DOCUMENT WITHOUT THE WRITTEN PERMISSION OF PROCESS TUBE SYSTEMS INC. IS STRICTLY PROHIBITED.

PROCESS TUBE SYSTEMS INC. 2 CYLINDER CABINET LABEL LAYOUT	TITLE OR DESCRIPTION 2 CYLINDER CABINET LABEL LAYOUT	DRAWN BY J. J. JONES	CHECKED BY J. J. JONES	DATE 11/25/02
--	---	-------------------------	---------------------------	------------------

REV.	DESCRIPTION	DATE
0	INITIAL RELEASE	1/22/02

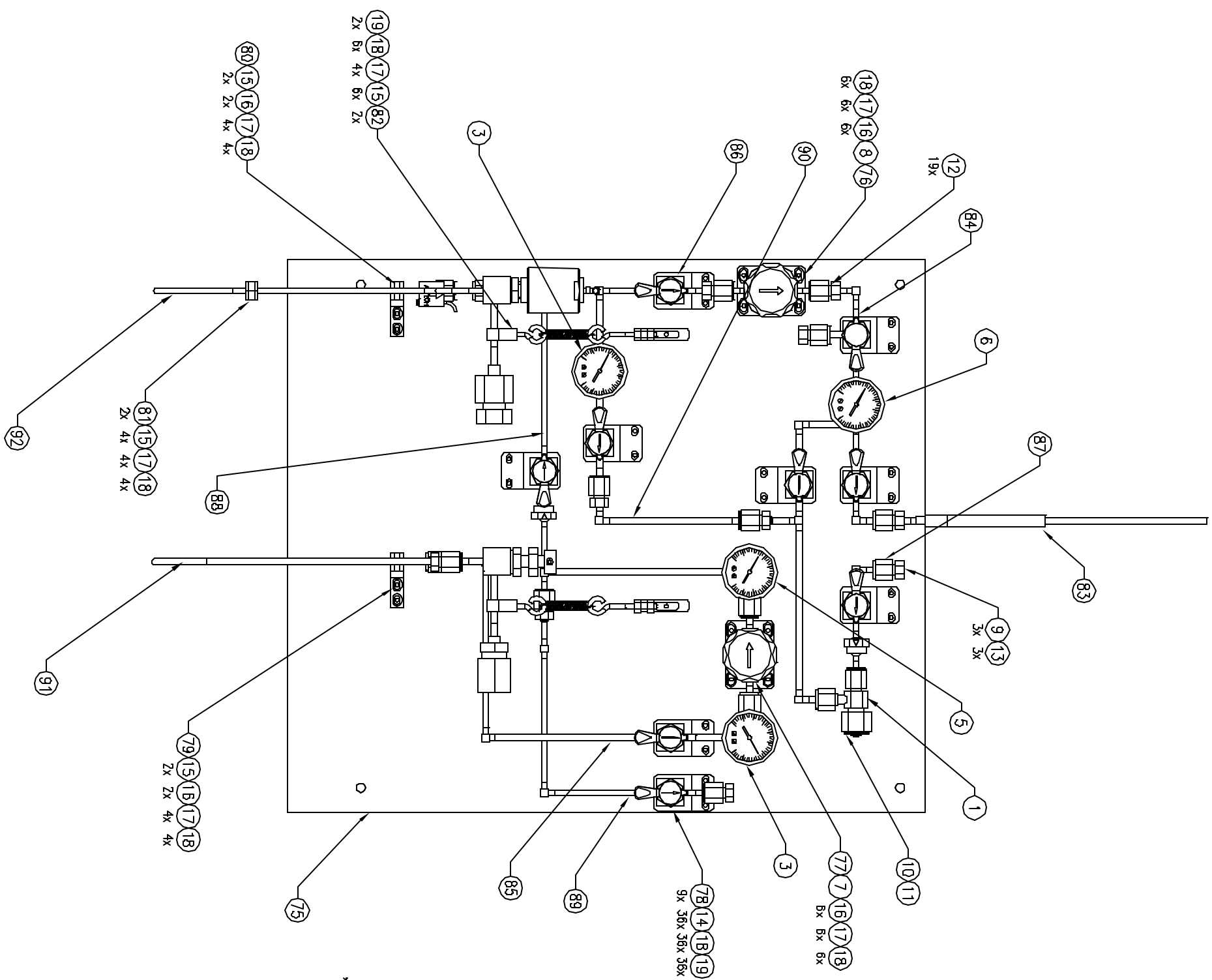
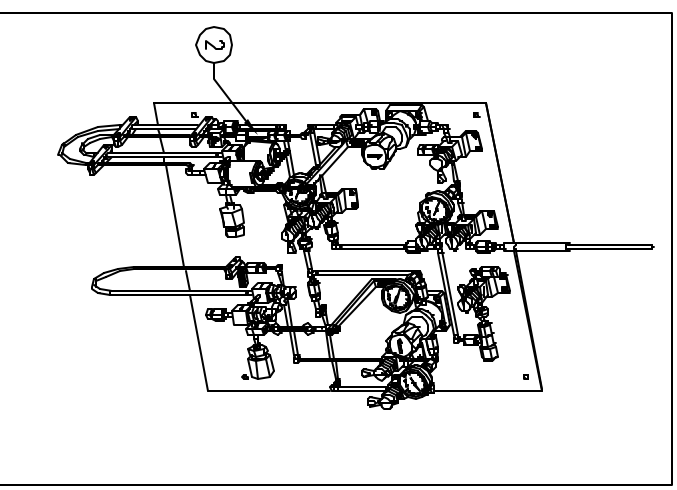

*^{1/4"} INDICATES COMPONENTS THAT MUST BE RECORDED ON FORM TITLED COMPONENT SERIAL LOG

92	OS01232-001	679 CGA PIGTAIL	0	PTS	1
91	OS01231-001	580 CGA PURGE PIGTAIL	0	PTS	1
90	U01220-001	WELDMENT #1	0	PTS	1
89	OS01215-001	MANIFOLD #6	0	PTS	1
88	OS01214-001	MANIFOLD #5	0	PTS	1
87	U01213-001	MANIFOLD #4	0	PTS	1
86	U01212-001	MANIFOLD #3	1	PTS	1
85	U01211-001	MANIFOLD #2	0	PTS	1
84	U01210-001	MANIFOLD #1	1	PTS	1
83	PT10221-002	WELDMENT #2 VER-002	0	PTS	1
82	PT50600-016A	PICTAL SUPPORT (8.34LG)	0	TBD	2
81	PT10103-001	DOUBLE TUBE PICTAL CLAMP	0	TBD	2
80	PT10102-001	DOUBLE 1" TUBE CLAMP	0	TBD	1
79	PT10101-001	SINGLE 1" TUBE CLAMP	0	TBD	1
78	PTS110-001	V.V. BRACKET(1.00 TALL)	3	TBD	9
77	PTS102-002	REG. BASE (.75THK)	9	TBD	1
76	PTS100-002	REG. BASE (.75THK)	0	TBD	1
75	U01201-001	GAS PANEL	0	TBD	1
19	71009	#10 FLAT WASHER	45	FASTENAL	1
18	71057	#10 LOCK WASHER	69	FASTENAL	1
17	11082-00262	#10 FLAT WASHER	24	FASTENAL	1
16	73449	10-32 SHCS 5/8" LONG	16	FASTENAL	1
15	73448	10-32 SHCS 1/2" LONG	17	FASTENAL	1
14	73447	10-32 SHCS 3/8" LONG	36	FASTENAL	1
13	NI-4-VCR-2-GR-VS-BL	1/4" BLIND GASKET	3	CAJON	3
12	NI-4-VCR-2-GR-VS	1/4" GASKET	19	CAJON	19
11	NI-8-VCR-2-VS	1/2" GASKET (NO RETAINER)	1	CAJON	1
10	SS-8-VCR-CP	1/2" CAP	1	CAJON	1
9	SS-4-VCR-P	1/4" PLUG	3	CAJON	3
8	AP1515-SH-2PW-FV4-FV4	3500 x 150psi REGULATOR	1	APTECH	1
7	AP1010-S-2PW-FV4-FV4	3500 x 100psi REGULATOR	1	APTECH	1
6	PGU-50-PC160-C-4SFM	30-D-160psi GAUGE	1	SMAGELOK	1
5	PGU-50-PC100-C-4SFM	30-D-100psi GAUGE	1	SMAGELOK	1
4	-	NOT USED	-	-	-
3	PGU-50-P-3000-C-4FSM-IS	0-3000psi SW GAUGE	2	SMAGELOK	2
2	GFE400XIV4	1/4" INLINE FILTER	1	PALL	1
1	AP7D-S-3PW-MW4-MW6-MW4	VACUUM GENERATOR	1	APTECH	1

PROCESS TUBE SYSTEMS INC.

GAS ASSEMBLY

2 CYLINDER CABINET

REV. 001A
0501200-001A
0

SHEET 1 OF 1

THIS DOCUMENT CONTAINS CONFIDENTIAL OR PROPRIETARY INFORMATION OF PROCESS TUBE SYSTEMS INC. NEITHER THE DOCUMENT NOR THE INFORMATION CONTAINED HEREIN IS TO BE REPRODUCED, COPIED, OR TRANSMITTED IN ANY FORM OR BY ANY MEANS, ELECTRONIC OR MECHANICAL, INCLUDING PHOTOCOPYING, RECORDING, OR BY ANY INFORMATION STORAGE AND RETRIEVAL SYSTEM, WITHOUT THE EXPRESS WRITTEN PERMISSION OF PROCESS TUBE SYSTEMS INC. THIS DOCUMENT IS THE PROPERTY OF PROCESS TUBE SYSTEMS INC. AND MAY BE RETURNED TO THE ISSUING OFFICE AT THE END OF THE SERVICE PERIOD.

REV.	DESCRIPTION	DATE
4	UPREV ON FILE P/S	12/9/02

LABEL (BACK OF CABINET):
N2 PURGE INLET
100psi MAX

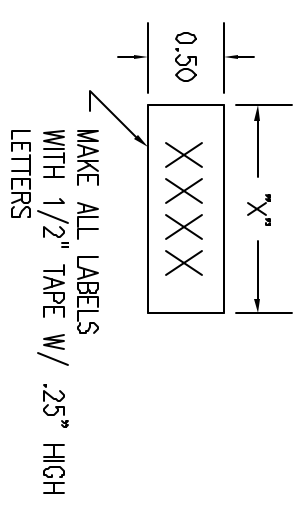
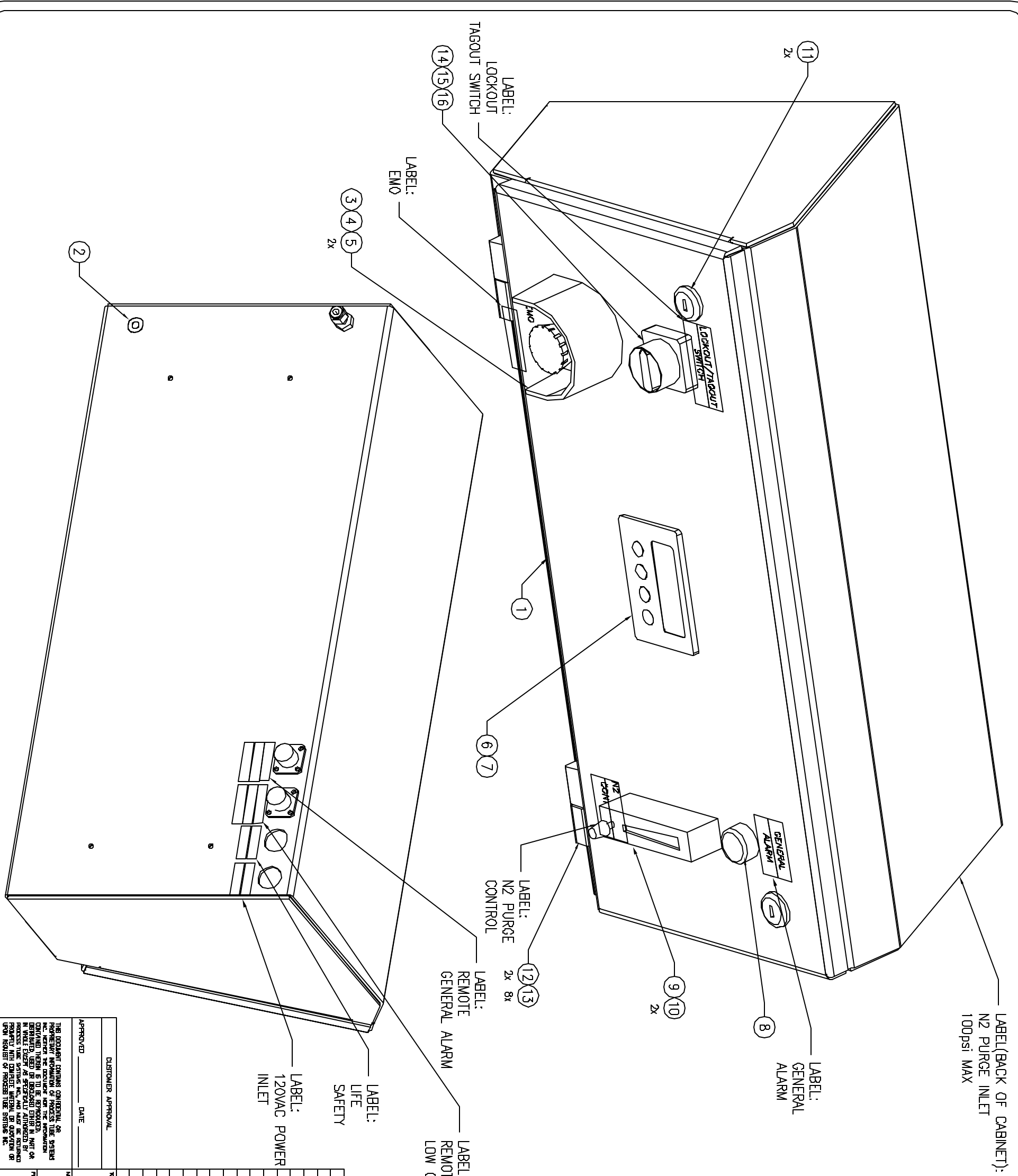

ITEM	PART#	DESCRIPTION	REV	MANUF.	QTY
16	ENT500315.05	PROTECTIVE COVER	-	ENTRELEC	1
15	ENT47134915	LOCK OUT HANDLE ASSEMBLY	-	ENTRELEC	1
14	ENT51041117	SWITCH ASSEMBLY	-	ENTRELEC	1
13	73722	B-32 1/2" LONG BH	-	FASTENAL	8
12	G6-5-1	HINGE	-	SOUTHCO	2
11	E3-19-25	LATCH	-	SOUTHCO	2
10	B-400-1-2	1/4" MALE CONN	-	SWAGelok	2
9	VFA-5-SSV	24 VDC RED LIGHT	-	DWYER	1
8	ECX1051-24	24 VDC RED LIGHT	-	AUTO DIR	1
7	MTA-MINI-25	CABLE	-	DAIICHI	1
6	E50	INTERFACE	-	AUTO DIR	1
5	3SB3400-0C	CC CONTACT BLOCK	-	SIEMENS	2
4	3SR3921-OAK	YELLOW SHROUD	-	SIEMENS	1
3	3SR3201-1HA20	RED EMO	-	SIEMENS	1
2	9600K26	1/4" GROMMET	-	MCMASTER	1
1	1/8" TH x 1/2" W	SELF ADHESIVE GASKET	-	INDUST GAS & 17	1

PROCESS TUBE SYSTEMS INC.

CONTROLER ASSEMBLY

MANUAL 2 CYLINDER CABINET

CUSTOMER APPROVAL
APPROVED _____ DATE _____

THE DOCUMENT CONTAINS CONFIDENTIAL OR PROPRIETARY INFORMATION OF PROCESS TUBE SYSTEMS INC. REVIEWER'S SIGNATURE FOR THE INFORMATION CONTAINED HEREIN IS THE SOLE AUTHORITY FOR ANY REVISIONS TO THIS DOCUMENT. NO PART OF THIS DOCUMENT IS TO BE REPRODUCED OR TRANSMITTED IN ANY FORM OR BY ANY MEANS, ELECTRONIC OR MECHANICAL, INCLUDING PHOTOCOPYING, RECORDING, OR BY ANY INFORMATION STORAGE AND RETRIEVAL SYSTEM, WITHOUT THE WRITTEN PERMISSION OF PROCESS TUBE SYSTEMS INC.

REVISIONS	DATE	DESCRIPTION
1	12/9/02	INITIAL RELEASE
2		
3		
4		

REV.	DESCRIPTION	DATE
4	UP REV ON REV 75	12/9/02

REVISION BLOCK

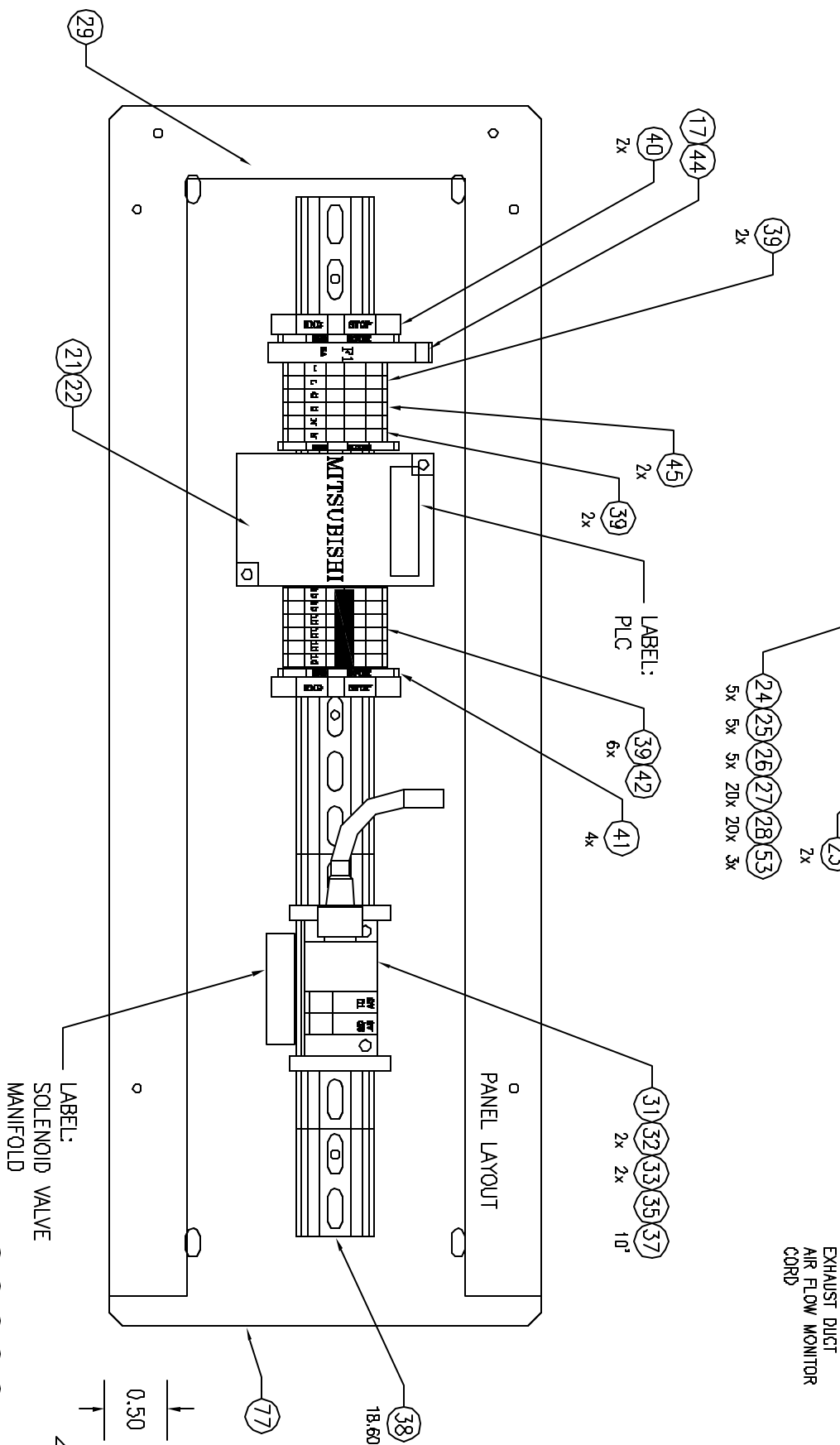
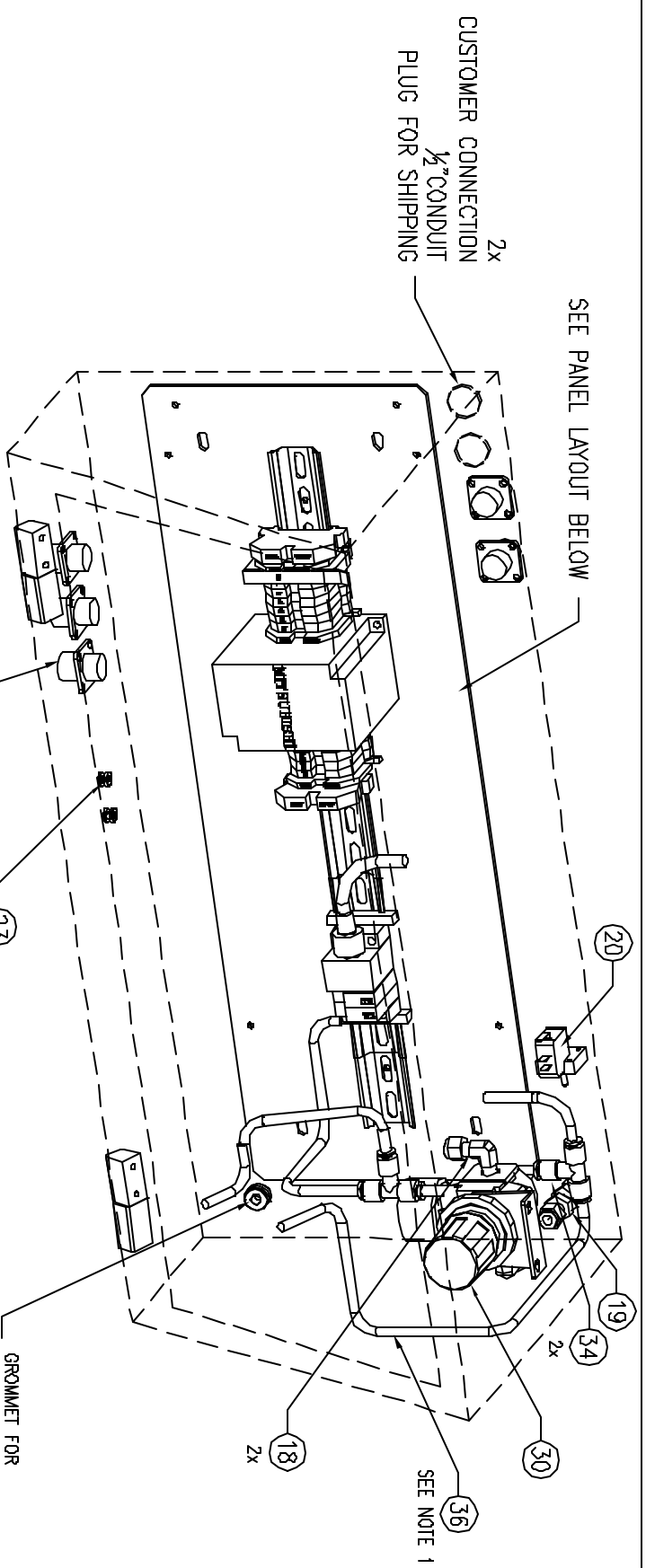
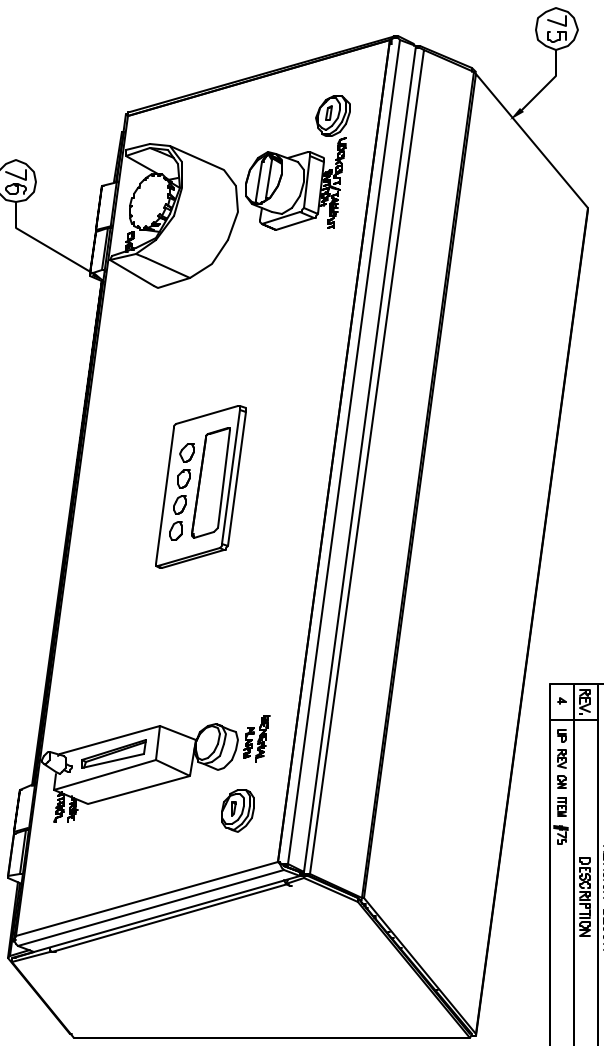

NOTE:
1. USE 1/4" POLY TUBING AS REQUIRED. MAKE SURE TO HAVE ENOUGH SLACK FOR DOOR TO OPEN & CLOSE EASILY.

MAKE ALL LABELS WITH 1/2" TAPE W/ .25" HIGH LETTERS

- 48 49 50 51 52
- 1' 8" 1' 2' 8"
- 43 46 47
- 12 24 10
- NOT SHOWN

ITEM	PART#	DESCRIPTION	REV	MANUF.	QTY
77	PT20303-001	CONTROLLER BACK PANEL	0	TBD	1
76	PT20302-001	CONTROLLER DOOR	2	TBD	1
75	PT20301-001	CONTROLLER BOX	5	TBD	1
53	54010-1	CABLE SHRINK BOOT	-	AMP	3
52	16MTWSTRWHBLU500	16AWG WH/BLU WIRE	-	PLATT	8
51	14MTWSTRBLK500	14AWG BLK WIRE	-	PLATT	2
50	14MTWSTR-GRNYEL	14AWG BRN/LW WIRE	-	PLATT	1
49	16MTWSTRBLU500	16AWG BLU WIRE	-	PLATT	8
48	14MTWSTRBLU500	14AWG WH/ WIRE	-	PLATT	1
47	BM-005081	14AWG BLU FERRULE	-	CONNECTORS	10
46	BM-005041	16AWG RD FERRULE	-	CONNECTORS	24
45	DN-G10	GROUND BLOCK	-	CONNECTORS	2
44	DN-F10	FUSE HOLDER	-	CONNECTORS	2
43	DN-LB	BLANK TERM BLK LABELS	-	CONNECTORS	12
42	DN-82J10	JUMPER STRIP (6 POS)	-	CONNECTORS	1
41	DC-EC1210	END COVER	-	CONNECTORS	4
40	DN-EB35	END BRACKET	-	CONNECTORS	2
39	DN-T10	TERMINAL BLOCK	-	CONNECTORS	10
38	DN-R35S1	35MM DIN RAIL	-	CONNECTORS	1.55'
37	TUB07C	1/8" POLY TUBE	-	SMC	10'
36	TUB07B	1/4" POLY TUBE	-	SMC	3'
35	KOL07-32-X13	1/4" x 10-32 ELBOW	-	SMC	1
34	KQ2T07-00	1/4" TEE	-	SMC	1
33	KOL01-32-X13	1/8"-10-32 ELBOW	-	SMC	2
32	VQ110-5F	24 VDC SOLENOID	-	SMC	2
31	W3011-02CS1-D	2 POSITION SOL MAN	-	SMC	1
30	MAR2000N02BG	REGULATOR	-	SMC	1
29	IBOT1015W	3/4" WIRE WAY	-	IBOXXO	4'
28	66399-6	SOCKET	-	AMP	20
27	66400-6	PIN	-	AMP	20
26	208082-1	CABLE CLAMP	-	AMP	5
25	208429-1	4 PIN PLUG ASSY	-	AMP	5
24	208430-3	4 PIN GPC 50 FINE RECP?	-	AMP	5
23	GT-2105-55B	1/8" GROUND	-	SERVICE RUB	2
22	FX1N-EEPROM-BL	EEPROM	-	MTSUBISHI	1
21	FX1S-14MR-ES/UL	PLC	-	MTSUBISHI	1
20	9011-020	PRESSURE SWITCH	-	WORUD MAG	1
19	SS-400-61	1/4" SWAGE BULKHEAD	-	SWAGelok	1
18	B-400-2-4	1/4" MALE ELBOW	-	SWAGelok	2
17	LR0215004	FUSE 5X20 4AMP	-	PLATT	1

PROCESS TUBE SYSTEMS INC.

CONTROLER ASSEMBLY

MANUAL 2 CYLINDER CABINET

PT20300-001A 4

OSU 2 Cylinder CABINET

Manufacturer's Parts Index

Part Number	Description	Manufacturer
REGULATORS		
AP1010-S-2PW-FV4-FV4	3500-100 psi regulator	AP TECH
AP1515-SH-2PW-FV4-FV4	3500-150 psi regulator	AP TECH
NAR2000N02BNG	pneumatic control regulator	SMC
VALVES		
AP3625-S-3PW-TW4-TW4	¼" 3-PORT manual valve	AP TECH
AP3625-S-2PW-TW4-TW4	¼" manual valve	AP TECH
AP3625-S-2PW-TW4-TW4	¼" manual valve "B" pattern	AP TECH
VQ110-5F	24 VDC Solenoid valve	SMC
VV3Q11-02SC1-D	solenoid manifold	SMC
CHECK VALVE		
AP 64-S-TW4-TW4	¼" check Valve	AP TECH
VACUUM GENERATOR		
AP70-S-3PW-MV4-MV6-MV4	Vacuum Generator	AP TECH
EXCESS FLOW SWITCH		
AP74-002-S-2PWB-TW4-TW4	EFS Switch 2 SLPM	AP TECH

Manufacturer's Parts Index (cont.)

Part Number	Description	Manufacturer
PRESSURE SWITCH		
9011-020	Pressure Switch	World Magnetics
FLOW METERS		
VFA-5-SSV	Flow meter	Dwyer
FILTERS		
GLFPF3000VMM4	¼" MVCR ½ SLPM Filter	PALL
GAUGES		
PGU-50-PC100-4FSM	30-0-100 psi	Swagelok (Wika)
PGU-50-PC160-4FSM	30-0-160 switch gauge	Swagelok (Wika)
PGU-50-P3000-C-- 4FSM-IS	30-0- 3000 psi switch gauge	Swagelok (Wika)

Regulators

Compressed air regulators are available in modular or inline models, in port sizes from 1/8" to 2".

Contents

R07 Miniature General Purpose Filter 1/8" and 1/4" ports	ALE-5-2
R46 Miniature, Non-repairable General Purpose Filter 1/4" to 3/8" ports	ALE-5-4
R72G/R Excelon General Purpose Filter 1/4" to 3/8" ports	ALE-5-6
R73G/R Excelon General Purpose Filter 1/4" to 1/2" ports	ALE-5-8
R74G/R Excelon General Purpose Filter 3/8" to 3/4" ports	ALE-5-10
R64G/R Olympian Plus General Purpose Filter 1/4" to 3/4" ports	ALE-5-12
R68G Olympian Plus General Purpose Filter 3/4" to 1-1/2" ports	ALE-5-14
R17G General Purpose Filter 3/4" to 1-1/2" ports	ALE-5-16
R18G General Purpose Filter 1-1/2" and 2" ports	ALE-5-18



R07



R46



R72G/R



R73G/R



R74G/R



R64G/R

Product available
1st quarter of 2001



R68



R17



R18

Miniature Series 07 General Purpose Regulator 1/8" and 1/4" Port Sizes

- Compact design
- Full flow gauge ports
- Low torque, non-rising adjusting knob
- Snap action knob locks pressure setting when pushed in
- Standard relieving models allow reduction of outlet pressure even when the system is dead-ended
- Can be disassembled without the use of tools or removal from the air line



Ordering Information. Models listed include PTF threads, relieving diaphragm, 5 to 100 psig (0.3 to 7 bar) outlet pressure adjustment range*, with gauge.

Port Size	Model Number	Flow† scfm (dm ³ /s)	Weight lbs (kg)
1/8"	R07-100-RGKA	14 (6.5)	0.31 (0.19)
1/4"	R07-200-RGKA	15 (7)	0.31 (0.19)

† Approximate flow at 100 psig (7 bar) inlet pressure, 90 psig (6.3 bar) set pressure and a droop of 14.5 psig (1 bar) from set.

Alternative Models

Port Size	Substitute
1/8"	1
1/4"	2

Option	Substitute
Not applicable	0

Option	Substitute
Standard	0
Low flow seat	2

R 0 7 - ★ ★ ★ - ★ ★ ★ ★

Threads	Substitute
PTF	A
ISO Rc taper	B
ISO G parallel	G

Outlet Pressure Adjustment Ranges*	Substitute
1 to 10 psig (0.1 to 0.7 bar)	A
5 to 50 psig (0.3 to 3.5 bar)	E
5 to 100 psig (0.3 to 7 bar)	K

Gauges	Substitute
With	G
Without	N

Diaphragm	Substitute
Relieving	R
Non relieving	N

* Outlet pressure can be adjusted to pressures in excess of, and less than, those specified. Do not use these units to control pressures outside of the specified ranges.

ISO Symbols

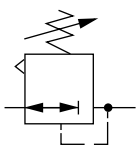

Relieving

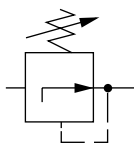

Non relieving

See Section ALE-25 for Accessories



Technical Data

Fluid: Compressed air

Maximum pressure: 300 psig (20 bar)

Operating temperature: -34° to 150°F (-35° to 65°C) *

* Air supply must be dry enough to avoid ice formation at temperatures below 2°C (35°F).

Typical flow at 150 psig (10 bar) inlet pressure, 90 psig (6.3 bar) set pressure and a droop of 15 psig (1 bar) from set:

1/8" ports: 14 scfm (6.5 dm³/s)

1/4" ports: 15 scfm (7 dm³/s)

Gauge ports:

1/8" PTF with PTF main ports

1/8" ISO Rc with ISO Rc main ports

1/8" ISO Rc with ISO G main ports

Materials:

Body: Zinc

Bonnet: Acetal

Valve: Brass/nitrile

Valve seat: Acetal

Elastomers: Nitrile

Typical Performance Characteristics

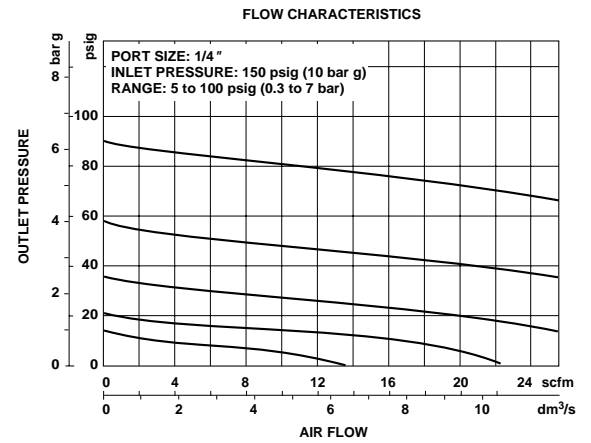

Service Kits

Item	Type	Part number
Service kit	Relieving	3407-02
	Non relieving	3407-01

Service kit includes slip ring, diaphragm, standard valve seat with o-ring, valve, valve spring.

All Dimensions in Inches (mm)

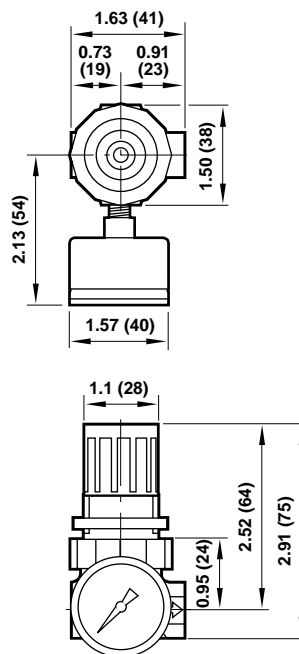

Panel mounting hole diameter 1.19" (30 mm)
Maximum panel thickness 0.25" (6 mm)

Miniature Non-repairable Pressure Regulator 1/4" Port Size

- Reliable pressure regulation at air flows up to 13 scfm (6 dm³/s)
- Compact design and light weight construction
- Wrench flats for easy installation
- Relieving piston design allows reduction of downstream pressure when the system is dead-ended
- Choice of left to right or right to left flow



Ordering Information. Model listed has left to right flow, 5 to 125 psig (0.3 to 8.5 bar) outlet pressure adjustment range*, and PTF threads. Gauge is not included.

Port Size	Model	Flow [†] scfm (dm ³ /s)	Weight lb (kg)
1/4"	R46-200-RNLA	13 (6)	0.2 (0.09)

† Typical flow with 150 psig (10 bar) inlet pressure, 90 psig (6.3 bar) set pressure and 15 psig (1 bar) droop from set.

Alternative Models

R 4 6 - ★ ★ ★ - ★ ★ ★ ★

Port Size	Substitute	Threads	Substitute
1/4"	2	PTF	A
		ISO Rc taper	B
		ISO G parallel	G
Flow Direction With Knob Up and Gauge Visible	Substitute	Outlet Pressure Adjustment Ranges*	Substitute
Left to Right	00	5 to 50 psig (0.3 to 3.5 bar)	E
Right to Left	02	5 to 125 psig (0.3 to 8.5 bar)	L
		5 to 150 psig (0.3 to 10 bar)	M
Piston Type	Substitute	Gauge	Substitute
Relieving	R	With	G
		Without	N

* Outlet pressure can be adjusted to pressures in excess of, and less than, those specified. Do not use these units to control pressures outside of the specified ranges.

ISO Symbols

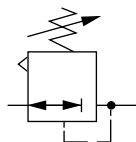

Relieving

See Section ALE-25 for Accessories



Technical Data

Fluid: Compressed air

Maximum pressure: 250 psig (17 bar)

Operating temperature*: -30° to 150°F (-34° to 65°C)

*Air supply must be dry enough to avoid ice formation at temperatures below 35°F (2°C).

Typical flow with 150 psig (10 bar) inlet pressure, 90 psig (6.3 bar) set pressure and 15 psig (1 bar) droop from from set: 13 scfm (6 dm³/s)

Gauge ports:

1/8 PTF with PTF main ports

Rc1/8 with ISO G and ISO Rc main ports

Materials

Body: Zinc

Knob: Nylon

Valve: Nitrile compound

Valve seat: Acetal

Elastomers: Nitrile

Typical Performance Characteristics

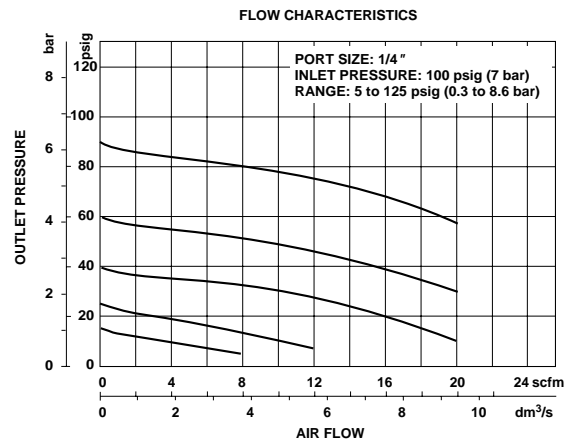
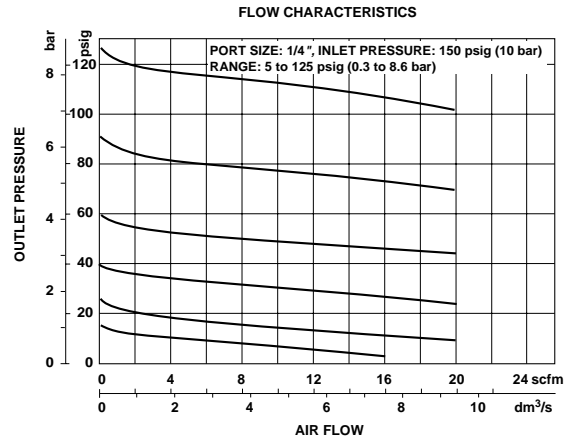

All Dimensions in Inches (mm)

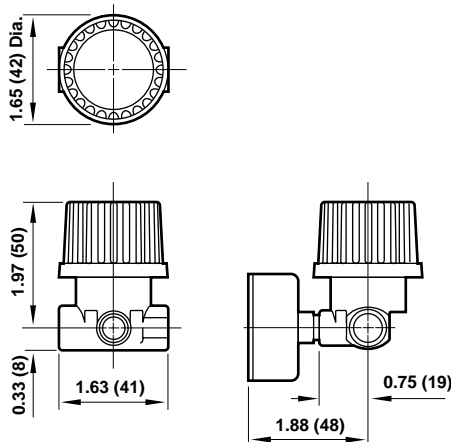

- Excelon design allows in-line or modular installation
- Full flow gauge ports
- Balanced valve design for optimum pressure control
- Push to lock adjusting knob with tamper resistant accessory
- R72R reverse flow option
- Modular installations with Excelon 72, 73, and 74 series can be made to suit particular applications



Ordering Information. Models listed include unidirectional flow, PTF threads, knob adjustment, relieving diaphragm, 5 to 150 psig (0.3 to 10 bar) outlet pressure adjustment range* with gauge.

Port Size	Model	Flow [†] scfm (dm ³ /s)	Weight lb (kg)
1/4"	R72G-2AK-RMG	70 (33)	0.79 (0.36)
3/8"	R72G-3AK-RMG	70 (33)	0.79 (0.36)

† Typical flow with 150 psig (10 bar) inlet pressure, 90 psig (6.3 bar) set pressure and a 15 psig (1 bar) droop from set.

Alternative Models

		R 7 2 ★ - ★ ★ ★ - ★ ★ ★				
Flow Type	Substitute				Gauge	Substitute
Standard	G				With	G
Reverse flow	R				Without	N
Port Size	Substitute				Outlet Pressure Adjustment Range*	Substitute
1/4"	2				5 to 30 psig (0.3 to 2 bar)	C
3/8"	3				5 to 60 psig (0.3 to 4 bar)	F
					5 to 150 psig (0.3 to 10 bar)	M
Threads	Substitute				Diaphragm	Substitute
PTF	A				Relieving	R
ISO Rc taper	B		Non relieving	N		
ISO G parallel	G				Adjustment	Substitute
					Knob	K
					T-bar	T

* Outlet pressure can be adjusted to pressures in excess of, and less than, those specified. Do not use these units to control pressures outside of the specified ranges.

ISO Symbols

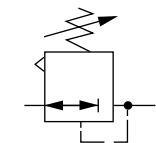

R72G Relieving

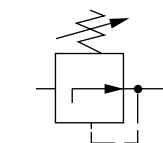

R72G Non Relieving

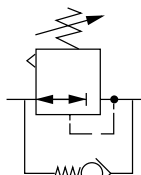

R72R Relieving

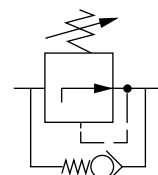

R72R Non Relieving

See Section ALE-25 for Accessories



Technical Data

Fluid: Compressed air

Maximum pressure: 300 psig (20 bar)

Operating temperature*: -30° to 150°F (-34° to 65°C)

* Air supply must be dry enough to avoid ice formation at temperatures below 35°F (2°C).

Approximate flow at 150 psig (10 bar) inlet pressure, 90 psig (6.3 bar) set pressure and a droop of 15 psig (1 bar) from set: 70 scfm (33 dm³/s)

Gauge ports:

1/8" PTF with PTF main ports

1/8" ISO Rc with ISO Rc main ports

1/8" ISO Rc with ISO G main ports

Materials:

Body: Zinc

Bonnet: Acetal

Valve: Brass

Elastomers: Nitrile

Bottom plug: Acetal

Typical Performance Characteristics

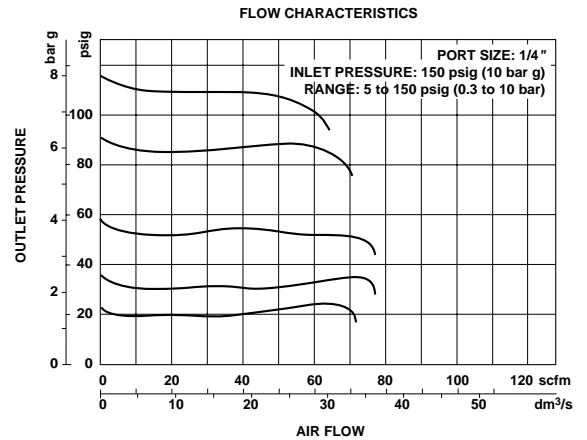

Service Kits

Item	Type	Part Number
Service kit	Relieving	4381-500
	Non relieving	4381-501

Service kit includes diaphragm assembly, valve assembly, valve spring and o-rings.

All Dimensions in Inches (mm)

Panel mounting hole diameter: 1.57" (40 mm)

Maximum panel thickness: 0.16" (4 mm)

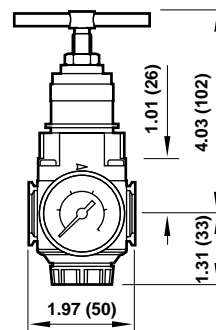
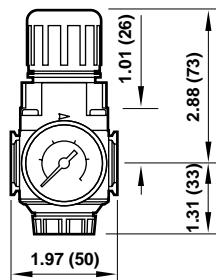
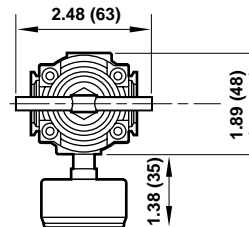
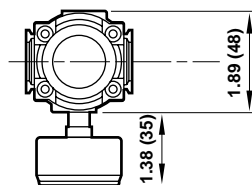

- Excelon design allows in-line or modular installation
- Full flow gauge ports
- Balanced valve design minimizes effect of variation in the inlet pressure on the outlet pressure
- Standard relieving models allow reduction of downstream pressure when the system is dead-ended
- Optional reverse flow models available for use downstream of directional control valves
- Modular installations with Excelon 72, 73, and 74 series can be made to suit particular applications



Ordering Information. Models listed include uni-directional flow, PTF threads, knob adjustment, relieving diaphragm, 5 to 150 psig (0.3 to 10 bar) outlet pressure adjustment range*, with gauge.

Port Size	Model	Flow [†] scfm (dm ³ /s)	Weight lb (kg)
1/4"	R73G-2AK-RMG	91 (43)	1.36 (0.6)
3/8"	R73G-3AK-RMG	144 (68)	1.36 (0.6)
1/2"	R73G-4AK-RMG	144 (68)	1.36 (0.6)

† Typical flow with 150 psig (10 bar) inlet pressure, 90 psig (6.3 bar) set pressure and 15 psig (1 bar) droop from set.

Alternative Models

Flow Type	Substitute	R 7 3 ★ - ★ ★ ★ - ★ ★ ★	Gauge	Substitute									
Uni-directional	G		<table border="1"> <thead> <tr> <th>Port Size</th> <th>Substitute</th> </tr> </thead> <tbody> <tr> <td>1/4"</td> <td>2</td> </tr> <tr> <td>3/8"</td> <td>3</td> </tr> <tr> <td>1/2"</td> <td>4</td> </tr> </tbody> </table>	Port Size	Substitute	1/4"	2	3/8"	3	1/2"	4	With	G
Port Size	Substitute												
1/4"	2												
3/8"	3												
1/2"	4												
Reverse	R	Without	N										
Threads	Substitute	<table border="1"> <thead> <tr> <th>Threads</th> <th>Substitute</th> </tr> </thead> <tbody> <tr> <td>PTF</td> <td>A</td> </tr> <tr> <td>ISO Rc taper</td> <td>B</td> </tr> <tr> <td>ISO G parallel</td> <td>G</td> </tr> </tbody> </table>	Threads	Substitute	PTF	A	ISO Rc taper	B	ISO G parallel	G	Outlet Pressure Adjustment Range*	Substitute	
Threads	Substitute												
PTF	A												
ISO Rc taper	B												
ISO G parallel	G												
Adjustment	Substitute	<table border="1"> <thead> <tr> <th>Adjustment</th> <th>Substitute</th> </tr> </thead> <tbody> <tr> <td>Knob</td> <td>K</td> </tr> <tr> <td>T-bar</td> <td>T</td> </tr> </tbody> </table>	Adjustment	Substitute	Knob	K	T-bar	T	5 to 60 psig (0.3 to 4 bar)	F			
Adjustment	Substitute												
Knob	K												
T-bar	T												
Diaphragm	Substitute	5 to 150 psig (0.3 to 10 bar)	M										
Relieving	R	10 to 250 psig (0.7 to 17 bar)	S										
Non relieving	N												

* Outlet pressure can be adjusted to pressures in excess of, and less than, those specified. Do not use these units to control pressures outside of the specified ranges.

ISO Symbols

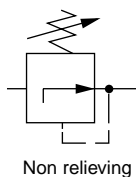
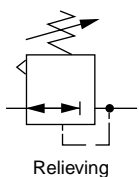

See Section ALE-25 for Accessories



Technical Data

Fluid: Compressed air

Maximum pressure: 300 psig (20 bar)

Operating temperature*: -30° to 175°F (-34° to 80°C)

*Air supply must be dry enough to avoid ice formation at temperatures below 35°F (2°C).

Typical flow with 150 psig (10 bar) inlet pressure, 90 psig (6.3 bar) set pressure and 15 psig (1 bar) droop from from set: 144 scfm (68 dm³/s)

Gauge ports:

1/4 PTF with PTF main ports

Rc1/4 with ISO Rc main ports

Rc1/8 with ISO G main ports

Materials

Body: Aluminum

Bonnet: Aluminum or Zinc

Valve: Brass

Elastomers: Nitrile

Bottom plug: Acetal

All Dimensions in Inches (mm)

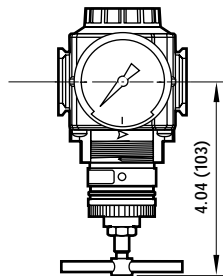
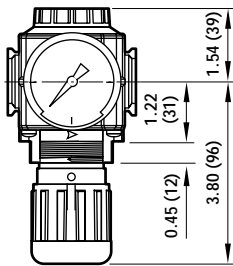
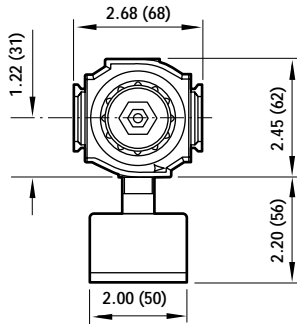

Panel mounting hole diameter: 1.89" (48 mm)

Panel thickness: 0.06" to 0.25" (2 to 6 mm)

Typical Performance Characteristics

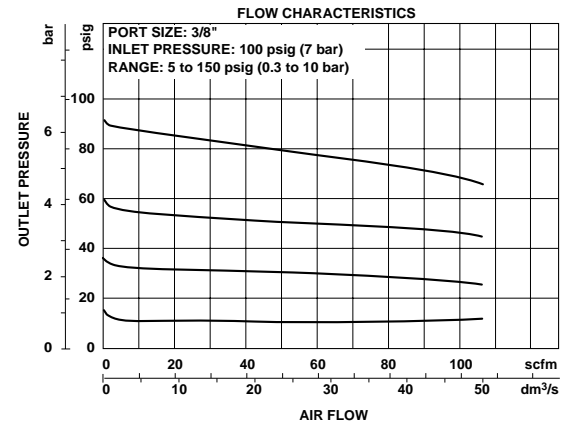
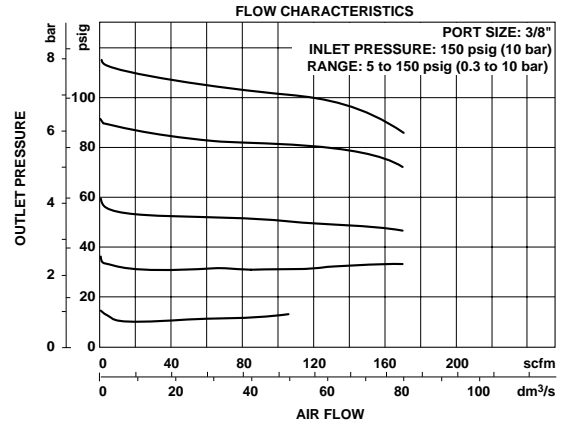

Service Kits

Item	Type	Part Number
Service kit	Relieving	4381-600
	Non-relieving	4381-601

Service kit includes diaphragm assembly, valve assembly, valve spring, bottom plug o-ring.

Excelon 74 Pressure Regulator
3/8", 1/2", 3/4" Port Sizes

- Excelon design allows in-line or modular installation
- Full flow gauge ports
- Balanced valve design minimizes effect of variation in the inlet pressure on the outlet pressure
- Standard relieving models allow reduction of downstream pressure when the system is dead-ended
- Optional reverse flow models available for use downstream of directional control valves
- Modular installations with Excelon 72, 73, and 74 series can be made to suit particular applications



Ordering Information. Models listed include uni-directional flow, PTF threads, knob adjustment, relieving diaphragm, 5 to 150 psig (0.3 to 10 bar) outlet pressure adjustment range*, with gauge.

Port Size	Model	Flow [†] scfm (dm ³ /s)	Weight lb (kg)
3/8"	R74G-3AK-RMG	208 (98)	1.80 (0.82)
1/2"	R74G-4AK-RMG	220 (105)	1.77 (0.80)
3/4"	R74G-6AK-RMG	220 (105)	1.73 (0.78)

† Typical flow with 150 psig (10 bar) inlet pressure, 90 psig (6.3 bar) set pressure and a droop of 15 psig (1 bar) from set.

Alternative Models

R 7 4 ★ - ★ ★ ★ - ★ ★ ★

Flow Type	Substitute
Uni-directional	G
Reverse	R

Port Size	Substitute
3/8"	3
1/2"	4
3/4"	6

Threads	Substitute
PTF	A
ISO Rc taper	B
ISO G parallel	G

Adjustment	Substitute
Knob	K
T-bar	T

Gauge	Substitute
With	G
Without	N

Outlet Pressure Adjustment Range*	Substitute
5 to 60 psig (0.3 to 4 bar)	F
5 to 150 psig (0.3 to 10 bar)	M
10 to 250 psig (0.7 to 17 bar)**	S

Diaphragm	Substitute
Relieving	R
Non relieving	N

* Outlet pressure can be adjusted to pressures in excess of, and less than, those specified. Do not use these units to control pressures outside of the specified ranges.

** Units with 250 psig (17 bar) outlet pressure range are available only with the T-bar adjustment; therefore substitute **T** at the 7th position and **S** at the 9th position.

See Section ALE-25 for Accessories



Technical Data

Fluid: Compressed air

Maximum pressure: 300 psig (20 bar)

Operating temperature*: -30° to 175°F (-34° to 80°C)

*Air supply must be dry enough to avoid ice formation at temperatures below 35°F (2°C).

Typical flow with 150 psig (10 bar) inlet pressure, 90 psig (6.3 bar) set pressure and a droop of 15 psig (1 bar) from set: 220 scfm (105 dm³/s)

Gauge ports:

1/4 PTF with PTF main ports

Rc1/4 with ISO Rc main ports

Rc1/8 with ISO G main ports

Materials:

Body: Aluminum

Bonnet : Aluminum

Valve: Brass

Elastomers: Nitrile

Bottom plug: Acetal

All Dimensions in Inches (mm)

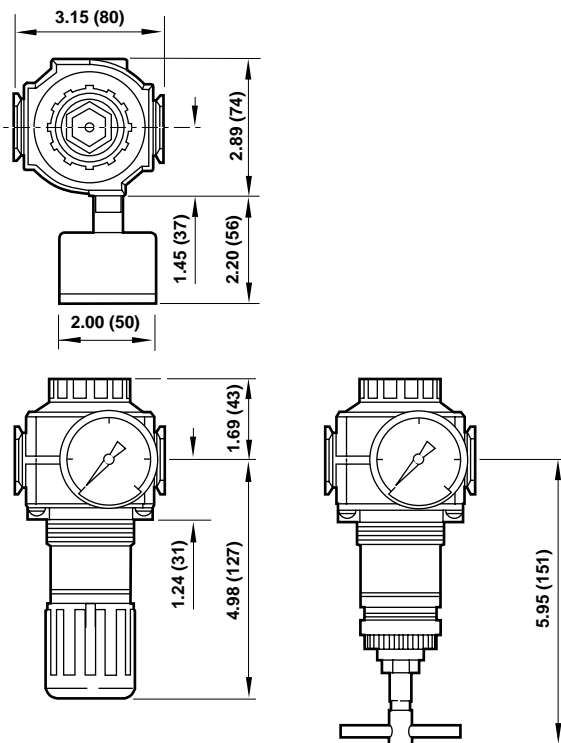

Panel mounting hole diameter: 2.06" (52 mm)

Panel thickness: 0.06" to 0.25" (2 to 6 mm)

ISO Symbols

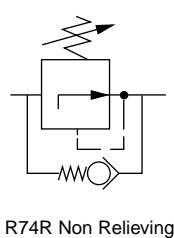
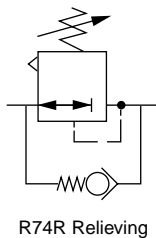
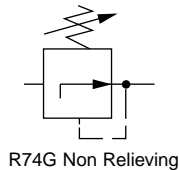
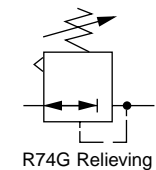

Typical Performance Characteristics

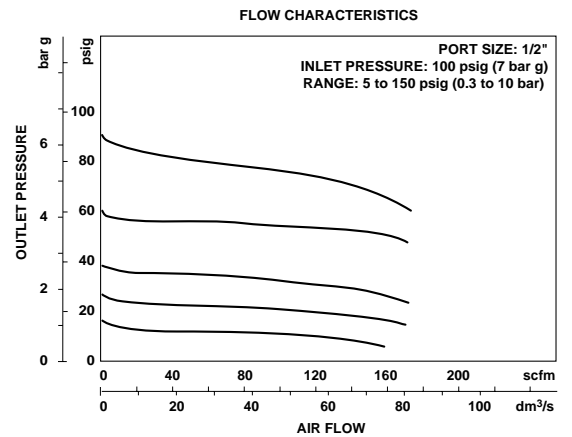
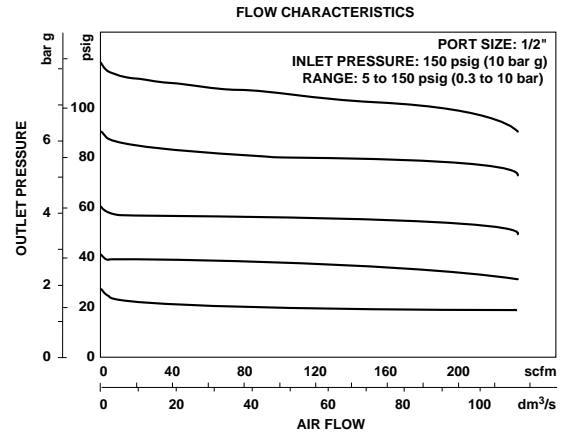

Service Kits

Item	Type	Part Number
Service kit	Relieving	4381-700
	Non relieving	4381-701

Service kit includes diaphragm assembly, valve assembly, valve spring, bottom plug o-ring.

Olympian Plus Regulator
1/4", 3/8", 1/2", 3/4" Port Sizes

- Olympian Plus plug in design
- High flow general purpose regulator
- Push to lock adjusting knob with tamper resistant option
- Mount in any orientation



Ordering Information. Models listed include unidirectional flow, PTF threads, knob adjustment, relieving diaphragm, 5 to 150 psig (0.3 to 10 bar) outlet pressure adjustment range* with gauge.

Port Size	Model	Flow [†] scfm (dm ³ /s)	Weight lb (kg)
1/4"	R64G-2AK-RMG	74 (35)	3.42 (1.54)
3/8"	R64G-3AK-RMG	170 (80)	3.38 (1.52)
1/2"	R64G-4AK-RMG	254 (120)	3.31 (1.49)
3/4"	R64G-6AK-RMG	N.A.	4.11 (1.85)

† Typical flow with 150 psig (10 bar) inlet pressure, 90 psig (6.3 bar) set pressure and a 15 psig (1 bar) droop from set.

For replacement regulator (without yoke) substitute 'N' at the 5th and 6th digits eg: R64G-NNK-RMN.

Alternative Models

R 6 4 ★ - ★ ★ ★ - ★ ★ ★

Flow Type	Substitute
Standard	G
Reverse flow	R

Port Size	Substitute
1/4"	2
3/8"	3
1/2"	4
3/4"	6

Threads	Substitute
PTF	A
ISO Rc taper	B
ISO G parallel	G

Gauge	Substitute
With	G
Without	N

Outlet Pressure Adjustment Range*	Substitute
5 to 60 psig (0.3 to 4 bar)	F
5 to 150 psig (0.3 to 10 bar)	M
10 to 250 psig (0.7 to 17 bar)	S**

Diaphragm	Substitute
Relieving	R
Non relieving	N

Adjustment	Substitute
Knob	K
T-bar	T

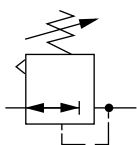
ISO Symbols

Relieving

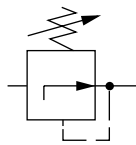

Non Relieving

* Outlet pressure can be adjusted to pressures in excess of, and less than, those specified. Do not use these units to control pressures outside of the specified ranges.

** Units with 250 psig (17 bar) outlet pressure range are available only with the T-bar adjustment; therefore substitute **T** at the 7th digit and **S** at the 9th position.

See Section ALE-25 for Accessories



Technical Data

Fluid: Compressed air

Maximum pressure: 250 psig (17 bar)

Operating temperature*: -30° to 175°F (-34° to 80°C)

* Air supply must be dry enough to avoid ice formation at temperatures below 35°F (2°C).

Typical flow at 150 psig (10 bar) inlet pressure, 90 psig (6.3 bar) set pressure and a droop of 15 psig (1 bar) from set: 254 scfm (120 dm³/s)

Gauge Ports:

1/8" PTF with PTF main ports

1/8" ISO Rc with ISO Rc main ports

1/8" ISO Rc with ISO G main ports

Materials:

Body: Zinc

Bonnet: Aluminium

Yoke: Zinc

Valve: Brass

Elastomers: Synthetic rubber

Typical Performance Characteristics

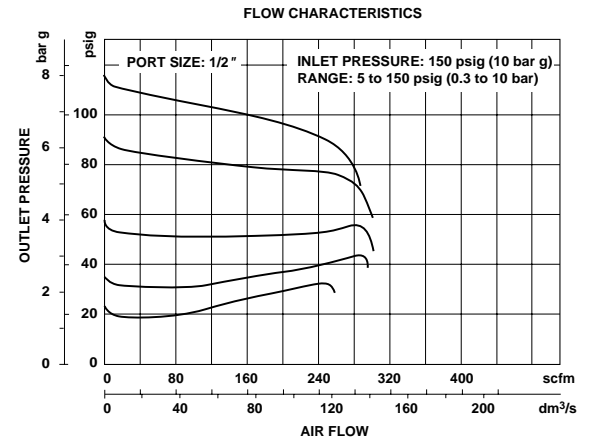

Service Kits

Item	Type	Part Number
Service kit	Relieving	4381-200
	Non relieving	4381-201

Service kit includes port and bottom plug 'O' rings, valve assembly, valve spring and diaphragm.

All Dimensions in Inches (mm)

Panel mounting hole diameter: 2.06" (52 mm)

Maximum panel thickness: 0.25" (6 mm)

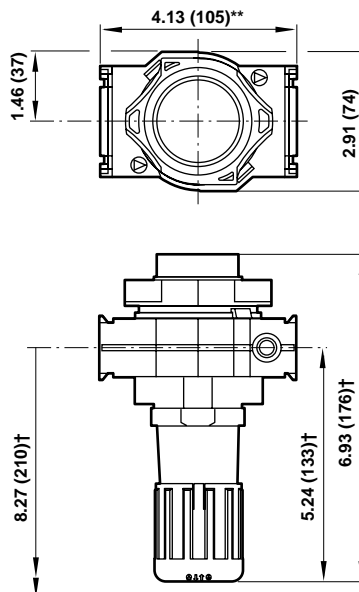

† Reduces by 4 mm with knob in locked position. Add 37 mm for unit with 'T' handle.

** 6.18" (157 mm) for models with 3/4" ports

- Olympian plug in design
- Robust and compact
- High flow unit with large valve and diaphragm
- Push to lock adjusting knob with tamper resistant option
-



68 Series products are available 1st quarter of 2001. Visit www.norgren.com for the latest data on this series.

Excellent flow and regulation characteristics



Ordering Information. Models listed include PTF threads, knob adjustment, relieving diaphragm, 5 to 120 psig (0.4 to 8 bar) outlet pressure adjustment range* without gauge.

Port Size	Model	Weight lb (kg)
3/4"	R68G-6AK-RLN	4.53 (2.04)
1"	R68G-8AK-RLN	4.53 (2.04)
1-1/4"	R68G-AAK-RLN	4.62 (2.08)
1-1/2"	R68G-BAK-RLN	4.71 (2.12)

Alternative Models

Port Size	Substitute	Threads	Substitute	Option	Substitute	Gauge	Substitute	Outlet Pressure Adjustment Range*	Substitute	Type	Substitute
3/4"	6	PTF	A	Adjusting knob	K	With	G	0 to 60 psig (0 to 4 bar)	F	Relieving	R
1"	8	ISO Rc taper	B	T-bar	T	Without	N	5 to 120 psig (0.4 to 8 bar)	L	Non relieving	N
1-1/4"	A	ISO G parallel	G					10 to 250 psig (0.7 to 17 bar)	S**	Relieving, Viton option	F
1-1/2"	B	None	N							Non relieving, Viton option	E
None	N										

ISO Symbol

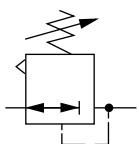

Relieving

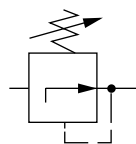

Non Relieving

* Outlet pressure can be adjusted to pressures in excess of, and less than, those specified. Do not use these units to control pressures outside of the specified ranges.

** Units with 250 psig (17 bar) adjustment range are available only with the T-bar adjustment; therefore substitute **T** at the 7th digit and **S** at the 9th position.



Technical Data

Fluid: Compressed air

Maximum pressure:
290 psig (20 bar)

Operating temperature*:
0° to 175°F (-20° to 80°C)

* Air supply must be dry enough to avoid ice formation at temperatures below 35°F (2°C).

Typical flow at 150 psig (10 bar) inlet pressure, 95 psig (6.3 bar)
(90 psig) set pressure and a droop of 15 psig (1 bar) from set:
381

Typical Performance Characteristics

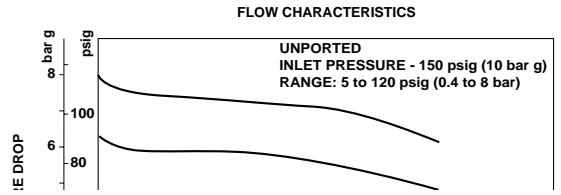

68 Series products are available 1st quarter of 2001. Visit www.norgren.com for the latest data on this series.

scfm (180 dm³/s) *TBA from Lab Tests*
Gauge ports: PTF 1/8

AIR FLOW

All Dimensions in Inches (mm)

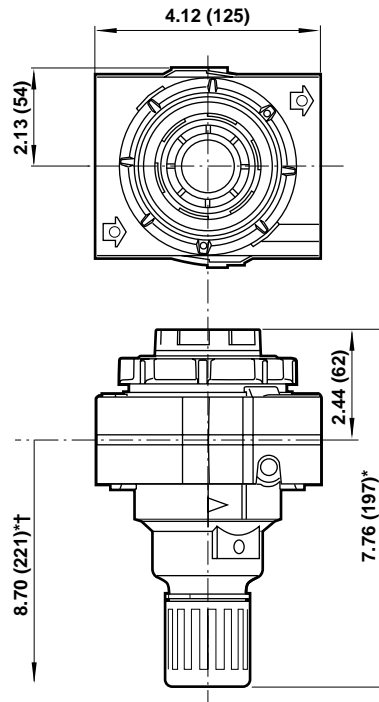

- * Reduces by 0.16" (4 mm) with knob in locked position. Add 1.46" (37 mm) for unit with T-handle
- † Minimum clearance required to remove unit.

17 Series General Purpose Regulator 3/4", 1", 1-1/4", and 1-1/2" Port Sizes

- Accurate and quick response to changes in flow demand and line pressure variations
- Balanced valve minimizes effect of changes in inlet pressure on outlet pressure
- Standard relieving models allow reduction of outlet pressure even when the system is dead-ended
- Full flow gauge ports
- Low torque, non-rising adjusting knob
- Integral locking device on knob adjustment
- Can be serviced without removal from the air line



Ordering Information. Models listed are knob adjustment, relieving type with gauge, 5 to 125 psig (0.3 to 8.5 bar) outlet pressure adjustment range*, and PTF threads.

Port Size	Model Number	Flow† scfm (dm ³ /s)	Weight lbs (kg)
3/4"	R17-600-RGLA	440 (208)	2.31 (1.05)
1"	R17-800-RGLA	480 (227)	2.02 (0.92)
1-1/4"	R17-A00-RGLA	400 (189)	2.68 (1.22)
1-1/2"	R17-B00-RGLA	440 (208)	2.59 (1.18)

† Typical flow with 150 psig (10 bar) inlet pressure, 90 psig (6.3 bar) set pressure and a 15 psig (1 bar) droop from set.

Alternative Models

R 1 7 - ★ ★ ★ - ★ ★ ★ ★

Port Size	Substitute
3/4"	6
1"	8
1-1/4"	A
1-1/2"	B

Option	Substitute
Not applicable	0
Adjustment	Substitute
Knob	0
T-bar	1

Diaphragm	Substitute
Relieving	R
Non relieving	N

Threads	Substitute
PTF	A
ISO Rc taper	B
BSPP (1-1/2" ported units only)	C
ISO G parallel (not available with 1-1/2" ported units)	G

Outlet Pressure Adjustment Ranges*	Substitute
5 to 50 psig (0.3 to 3.5 bar)	E
5 to 125 psig (0.3 to 8.5 bar)	L
10 to 250 psig (0.7 to 17 bar)	S

Gauge	Substitute
With	G
Without	N

* Outlet pressure can be adjusted to pressures in excess of, and less than, those specified. Do not use these units to control pressures outside of the specified ranges.

ISO Symbols

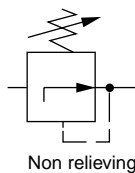
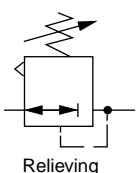

See Section ALE-25 for Accessories



Technical Data

Fluid: Compressed air

Maximum pressure: 300 psig (20 bar)

Operating temperature: -30° to 175°F (-34° to 80°C)*

* Air supply must be dry enough to avoid ice formation at temperatures 35°F (2°C).

Typical flow at 150 psig (10 bar) inlet pressure, 90 psig (6.3 bar) set pressure, and a droop of 15 psig (1 bar) from set: 480 scfm (227 dm³/s)

Gauge ports:

1/4" PTF with PTF main ports

R1/4 with ISO Rc, ISO G, and BSPP main ports

Materials

Body: Aluminum

Bonnet: Aluminum

Bottom plug: Acetal

Valve: Aluminum and nylon

Elastomers: Nitrile

Typical Performance Characteristics

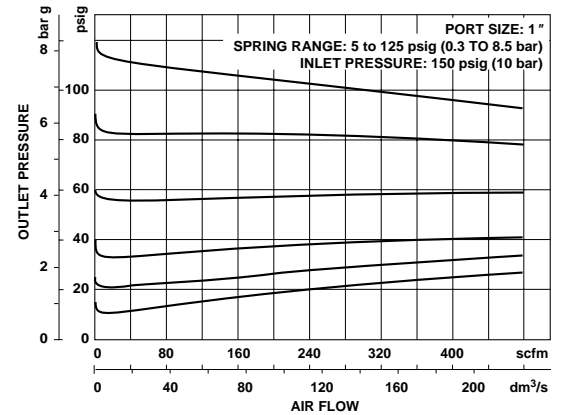

Service Kits

Item	Type	Part number
Service kit	Relieving	5578-02
	Non relieving	5578-01

Service kit contains, diaphragm, all o-rings, valve, and valve spring.

All Dimensions in Inches (mm)

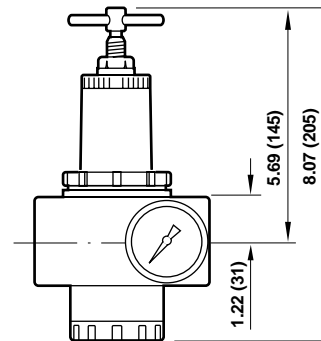
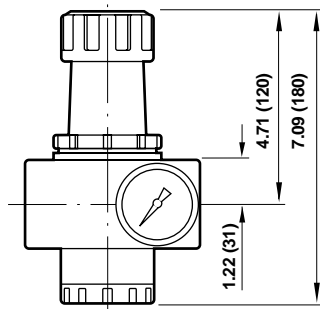
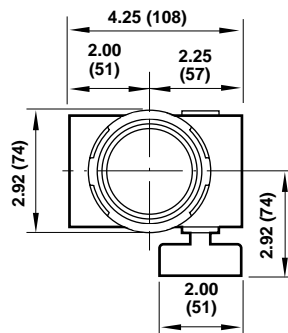

Panel mounting hole diameter: 2.28" (58 mm)

Panel thickness: 0.06" to 0.16" (2 to 4 mm)

18 Series General Purpose Pressure Regulator 1-1/2" and 2" Port Sizes

- The R18 with the conventional integral pilot provides good pressure regulation, rapid response to changing flow demands, and excellent stability.
- The R18 with the feedback integral pilot provides superior pressure regulation under changing flow demands where changes in flow demand are not sudden or cyclic.
- Balanced valve minimizes effect of changes in inlet pressure on outlet pressure
- Constant bleed feature in pilot regulator provides quick response and minimum dead-band
- Exceptionally high relief flow
- Full flow gauge ports
- Low torque, non-rising adjusting knob
- Integral locking device on knob adjustment



Ordering Information. Models listed include R40 conventional integral pilot, relieving diaphragm, with gauge, 5 to 125 psig (0.3 to 8.5 bar) outlet pressure adjustment range*, and PTF threads.

Port Size	Model	Flow [†] scfm (dm ³ /s)	Weight lb (kg)
1-1/2"	R18-B05-RGLA	2000 (944)	8.48 (3.85)
2"	R18-C05-RGLA	2000 (944)	8.27 (3.75)

† Typical flow with 100 psig (0.7 bar) inlet pressure, 90 psig (6.3 bar) set pressure and a droop of 15 psig (1 bar) from set.

Alternative Models

Port Size	Substitute	Pilot Regulator Type	Substitute	Port Threads	Substitute	Outlet Pressure Adjustment Ranges*	Substitute	Gauge	Substitute	Diaphragm	Substitute
1-1/2"	B	R40 Conventional	05	PTF	A	5 to 50 psig (0.3 to 3.5 bar)	E	With	G	Relieving	R
2"	C	R41 Feedback**	06	ISO Rc taper	B	5 to 125 psig (0.3 to 8.5 bar)	L	Without	N	Non relieving	N
				ISO G parallel	G	10 to 250 psig (0.7 to 17 bar)	S				

* Outlet pressures can be adjusted to pressures in excess or, and less than, those specified. Do not use these units to control pressures outside of the specified ranges.

** Requires relieving diaphragm and 250 psig (17 bar) spring (R in 7th position and S in 9th position) e.g. R18-B06-RNSG.

ISO Symbols

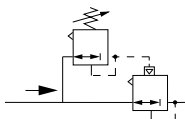

R18 with Conventional Pilot Regulator

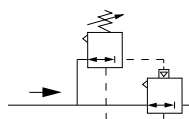

R18 with Feedback Pilot Regulator

See Section ALE-25 for Accessories



Technical Data

Fluid: Compressed air

Inlet pressure range: 10 psig (0.7 bar) minimum to 450 psig (31 bar) maximum

Operating temperature: -30° to 175°F (-34° to 80°C) *

* Air supply must be dry enough to avoid ice formation at temperatures below 35°F (2°C)

Typical flow with 100 psig (0.7 bar) inlet pressure, 90 psig (6.3 bar) set pressure, and a droop of 115 psig (bar) from set: 2000 scfm (944 dm³/s)

Gauge ports:

1/4" PTF with PTF main ports

G1/4 with ISO G main ports

R1/4 with ISO Rc main ports

Exhaust port:

3/4" PTF with PTF main ports

G3/4 with ISO G main ports

R3/4 with ISO Rc main ports

Maximum bleed rate: 0.25 scfm (0.12 dm³/s) at 50 psig (3.5 bar) outlet pressure.

Materials

Body: Aluminum

Bonnet: Aluminum

Bottom Plug: Aluminum

Valve

Integral Pilot Regulator: Teflon

Pilot Operated Regulator: Aluminum

Elastomers: Nitrile

Typical Performance Characteristics

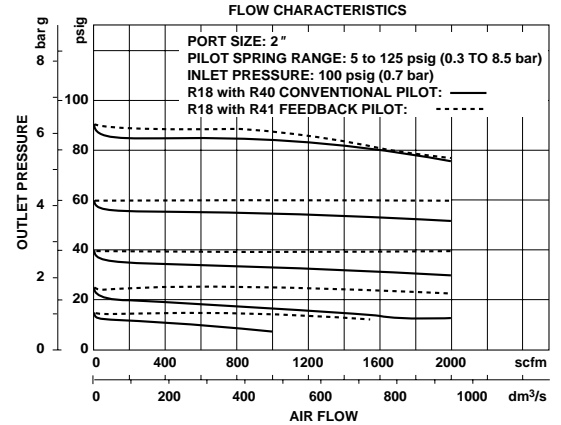

Service Kits

Item	Type	Part number
Service kits	R18 Pilot operated regulator**	5945-40
	R40 and R41 Pilot regulators†	5945-41

** Contains filter screen and all o-rings for R18 pilot operated regulator.

† Contains diaphragm, valve spring, valve, guide bushing, filter screen, and all o-rings for R40 and R41 pilot regulators.

All Dimensions in Inches (mm)

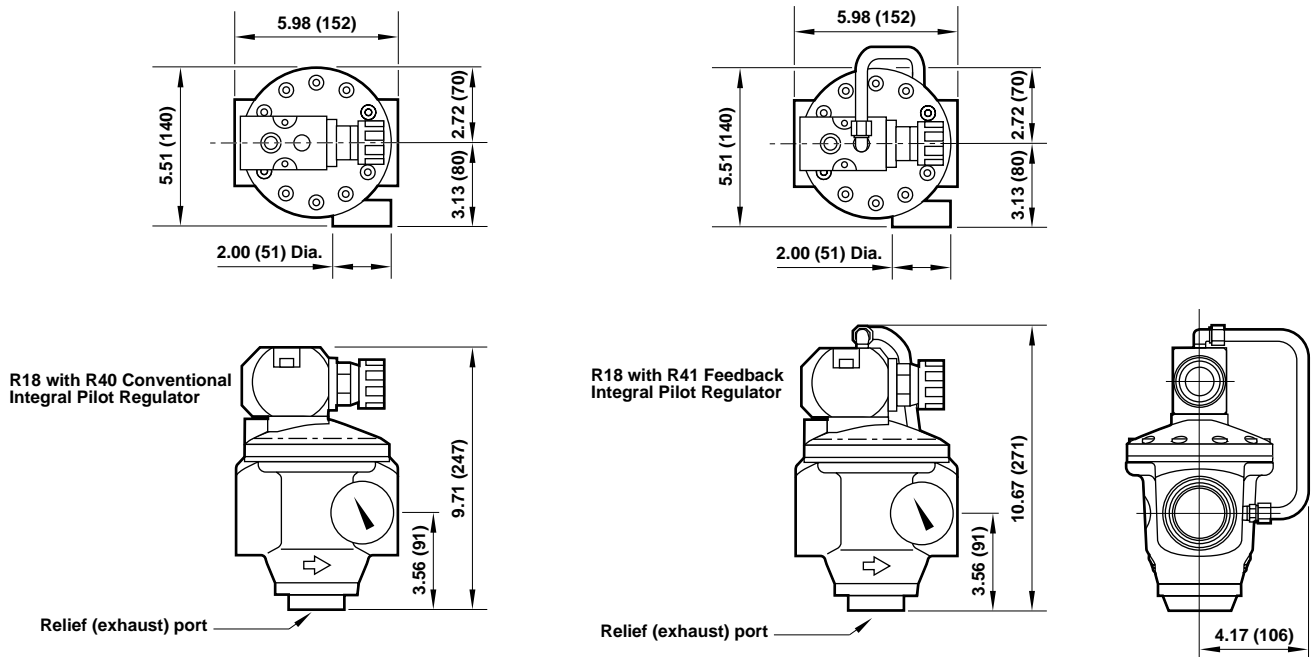



Ultramet-L Gaskleen® 4000 Series Assembly

Description

The Ultramet-L Gaskleen 4000 Series assembly is a unique, all 316L stainless steel filter capable of ≥ 3 nanometer (0.003 μm) filtration of semiconductor process gases.

- All 316L stainless steel construction
- State-of-the-art stainless steel medium
- Excellent particle removal efficiency vs. pressure drop
- Accommodates extremely high flow rates for the assembly size
- Excellent gas displacement and desorption characteristics
- High temperature and pressure capabilities
- Compact size for ease of installation
- Wide variety of fitting options available
- 100% helium leak checked
- Cleanroom manufactured and packaged

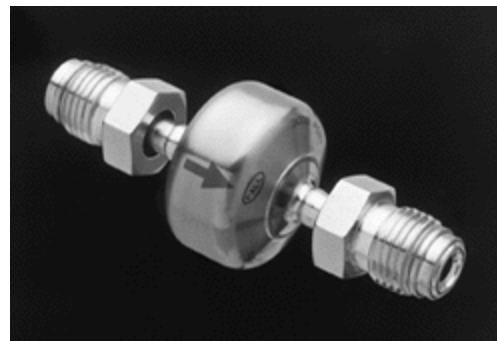

Specifications ▲

Materials

- Electropolished 316L stainless steel housing
- $\leq 7 \mu\text{in } R_a$ internal surface finish
- Cr:Fe (1:1) Chromium enriched internal surface chemistry
- VAR PLUS housing exceeds typical VIM VAR specifications
- All 316L stainless steel medium

Removal Rating

- $\geq 0.003 \mu\text{m}$

Connections

- 1/4" Gasket Seal, male (VCR¹ compatible)
- 1/4" Compression Seal, male (Swagelok¹ compatible)
- 1/4" Buttweld (Square Butt)

Operating Conditions

- Maximum Operating Pressure:
3000 psig @ 100°F/207 bar @ 38°C;
1685 psig @ 840°F/116 bar @ 450°C
- Maximum Allowable Differential Pressure:
125 psid @ 100°F/8.6 bar @ 38°C;
60 psid @ 840°F/4.1 bar @ 450°C

Particle Removal Characteristics

- 10⁹ particle reduction up to 6 slpm/0.2 scfm
- 10⁴ particle reduction up to 75 slpm/2.6 scfm

Leak Rating

- 100% helium leak tested to 10⁻⁹ atm cc/sec
- Design validated to 10⁻¹¹ atm cc/sec

¹VCR and Swagelok are trademarks of Swagelok Co.

Pressure Drop vs. Gas Flow Rate ▲

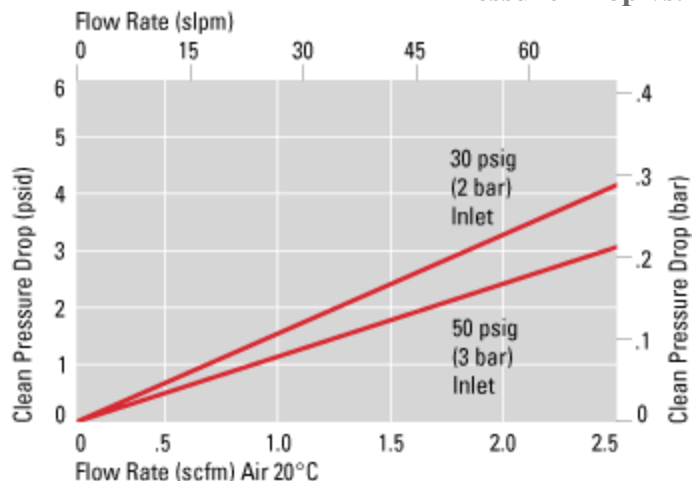

Dimensions ▲

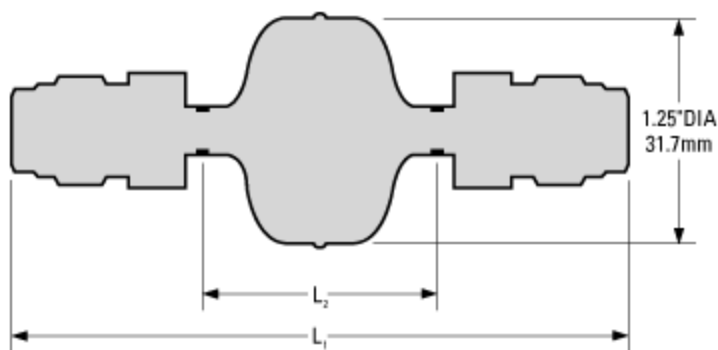

Part Number Information ▲

Part Number	Description	Length (in / mm)
GLFF4000VM4	1/4" Gasket Seal (VCR Compatible) Male/Male	3.31 / 84 (L ₁)
GLFF4000SM4	1/4" Compression Seal (Swagelok Compatible) Male/Male	2.88 / 73 (L ₁)
GLFF4000BW4	1/4" Butt weld	1.75 / 45 (L ₂)
GLFF4000VMM8	1/2" Gasket Seal (VCR Compatible) Male/Male	3.31 / 84 (L ₁)

[Home](#) |
 [Search](#) |
 [Product Finder](#) |
 [Contact Pall](#) |
 [Investor Information](#) |
 [Newsletters](#) |
 [Policies](#) |
 [Site Map](#)

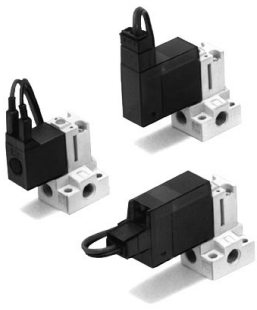

3 Port Solenoid Valve Series *VQ100*

How to Order Valve

VQ1 1 0 [] 5 F [] [] Q

Series VQ
Compact 3 port valve

Actuation

1	Normally closed
---	-----------------

Functions

—	Standard style (1W)
H	High pressure style (1.5W)
Y ⁽¹⁾	Low wattage style (0.5W)
L*	Latching style Positive COM
N*	Latching style Negative COM
U*	Large flow capacity style

* Option
Note 1) Except for latching and large flow capacity style.

Coil Rated Voltage

5	24V DC
6	12V DC
9	Other(50V or less)

Port size

—	Without sub-plate
M3	With sub-plate
M5	With sub-plate

Manual override

—	Non-locking push flush style
	Latching style: Push locking slotted style
B*	Locking slotted style

* Option
Note) Latching manual override: Push locking style only.

Electrical entry

F	Plug-in style With indicator light and surge voltage suppressor (only for plug-in manifold)	
L	L plug connector, With lead wire and light and surge voltage suppressor.	
LO	L plug connector, Without connector, With indicator light and surge voltage suppressor	
M	M plug connector, With lead wire and light and surge voltage suppressor.	
MO	M plug connector, Without connector, With indicator light and surge voltage suppressor	
G	Grommet	

Note) Grommet: No latching and large flow capacity.

Protective class class III (Mark:)

For safety precautions, precautions for products, product specifications, external dimensions, and model selection procedures, see the comprehensive catalog (Best Pneumatics) or the catalog for each individual product.

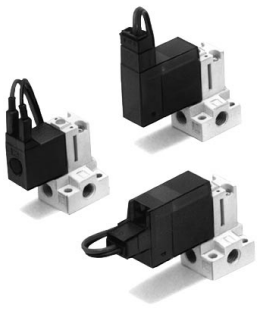

3 Port Solenoid Valve Series *VQ100*

How to Order Manifold

Plug Lead Unit Manifold

Applicable Solenoid Valve
(Plug lead style)
VQ1□0□-□L-Q
VQ1□0□-□M-Q
VQ1□0□-□G-Q



Note) Normally closed and normally open style cannot be mounted on the same manifold.

VVQ1000-10A-2

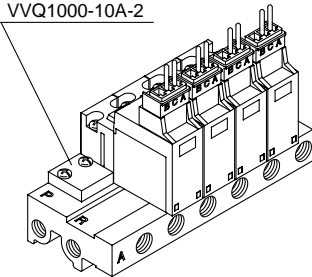

VV3Q 1 2 08 01N - Q

Series

1	VQ100
---	-------

Manifold base

2	Plug lead unit
2U	Plug lead unit U type (large flow capacity) mounting base

Stations

02	2 stations
⋮	⋮
20	20 stations

Port size* and thread

—	M5, Rc(PT)1/8
01N	NPT1/8
01T	NPTF1/8
01F	G(PF)1/8

* Only thread port size 1/8 style (2U type, P/E port) has choice of thread.

How to Order Manifold Assembly

Specify the model numbers of valve and option together with the manifold base part number.

〈Example〉

Plug lead unit manifold with cable (3m)

VV3Q12-05-Q 1 set Manifold base No.

* VQ110-5L-Q 4 sets Valve No. (1st to 4th stations)

* VVQ100-10A-2 1 set Blank plate part No. (5th station)

Put the "*" mark at the beginning of the part number of valves etc. to be mounted on the manifold.

Write sequentially from the 1st station on the D side.

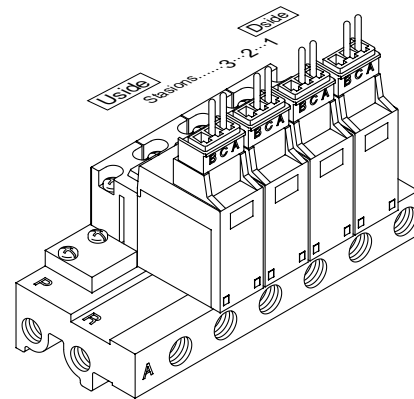

⚠ Protective class class III (Mark: ⚡)

⚠ For safety precautions, precautions for products, product specifications, external dimensions, and model selection procedures, see the comprehensive catalog (Best Pneumatics) or the catalog for each individual product.

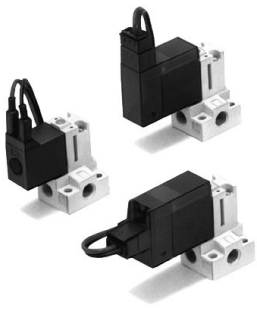

3 Port Solenoid Valve Series *VQ100*

How to Order Manifold

How to Order Manifold Assembly

Plug-in Unit Manifold

VV3Q 1 1 — 08 C U 1 — D — Q

Applicable Solenoid Valve (Plug-in style)

VQ1□0□-□F-Q

- Consult SMC for mounting latching style.
- Possible to mount U type (large flow capacity).

Series ●

1	VQ100
---	-------

Manifold base ●

1	Plug-in unit
---	--------------

Stations ●

02	2 stations
⋮	⋮
18	18 stations

Electrical entry ●

C	Multi-connector
---	-----------------

Connector location ●

U	Top entry
S	Side entry

Cable length ●

0	Without cable
1	With cable (1.5m)
2	With cable (3m)
3	With cable (5m)

Option ●

—	None
D	DIN rail mounted (With standard length of DIN rail)
DO ⁽¹⁾	DIN rail mounted (Without DIN rail)



Note 1) Order DIN rail separately.

Specify the model numbers of valve and option together with the manifold base part number.

< Example >

Plug-in unit manifold with cable (3m)

VV3Q11-05CU2-Q 1 set ——— Manifold base part No.
 * **VQ110-5F-Q** 4 set ——— Valve part No. (1st to 4th stations)
 * **VVQ100-10A-1** 1 set ——— Blank plate (5th station)

Put the "*" mark at the beginning of the part number of valves etc. to be mounted on the manifold.

Write sequentially from the 1st station on the D side.

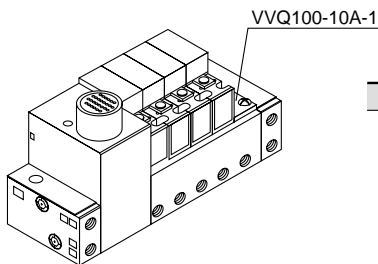
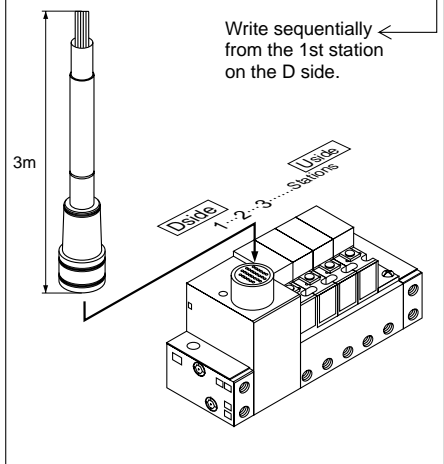

⚠ Protective class class III (Mark: ⚡)

⚠ For safety precautions, precautions for products, product specifications, external dimensions, and model selection procedures, see the comprehensive catalog (Best Pneumatics) or the catalog for each individual product.

Swagelok®

Pressure Gauges

Ultrahigh-Purity



Features

- 1 1/2 and 2 in. (40 and 50 mm) dial sizes
- Accuracy in accordance with ASME B40.1
- 316L VAR end connections
- Swagelok® VCR® face seal fittings

Features

Swagelok offers Bourdon tube pressure gauges to monitor positive system pressure and vacuum. Gauges are available for use in a wide range of applications, from bulk gas distribution to process tool applications. Gauges meet ASME B40.1 standards and are 100 % factory calibrated and helium leak tested to ensure the consistent, accurate performance you demand.

Technical Data

- **Accuracy:**
ASME B40.1 Grade A ($\pm 2\%$ / 1% / 2% of span)
(2 in. [50 mm] dial)
ASME B40.1 Grade B ($\pm 3\%$ / 2% / 3% of span)
(1 1/2 in. [40 mm] dial)
- **Range:**
–30 in. Hg vacuum to 200 psi (–1 to 13.6 bar) for compound gauges
0 to 3000 psi (0 to 200 bar) for positive-pressure gauges
- **Operating Temperature:**
Ambient: –40 to 140°F (–40 to 60°C)
Media: –40 to 212°F (–40 to 100°C)
- **Temperature Error:**
 $\pm 0.4\%$ for every 18°F (10°C) temperature change from 68°F (20°C)

Testing

Every ultrahigh-purity gauge is helium leak tested to a maximum rate of 2×10^{-9} std cm³/s.

Cleaning and Packaging





Gauges are assembled, cleaned, and packaged in a Class 10 work area; gauges are double bagged and vacuum sealed in cleanroom bags, and meet ASME B40.1, level IV.

Materials of Construction

Component	Material
<i>End connection (socket)</i>	316L VAR, electropolished
<i>Bourdon tube</i>	316L SS
Case	304 SS
Movement	300 series SS
Lens	Snap-in acrylic (1 1/2 in. [40 mm]) Twist-lock polycarbonate (2 in. [50 mm])
Dial	Aluminum
Pointer	Aluminum

Wetted components shown in *italics*.

End Connections

End Connection		Designator
1/4 in. female VCR face seal fitting		4FSF
1/4 in. male rotatable VCR face seal fitting		4FSM
1/4 in. male integral VCR face seal fitting		4FFM
1 1/2 in. surface mount (SEMI PR3.1 compliant)		4MSM

Dimensions and Pressure Ranges

Lower Mount Gauges

2 in. (50 mm) Lower Mount Gauge Dimensions

Dimensions, in inches (millimeters), are for reference only, subject to change.

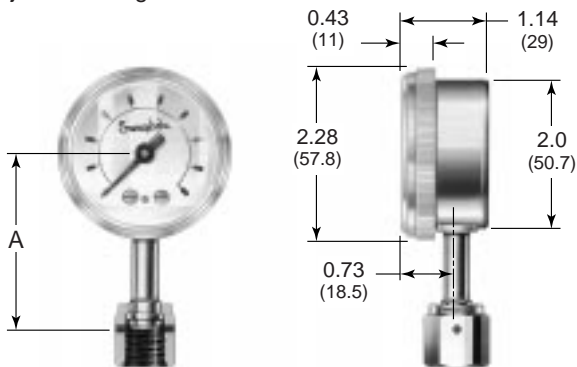

End Connection		Dimensions, in. (mm)	Weight, oz (g)
Type	Size		
Female VCR face seal fitting	1/4	2.32 (58.9)	4.4 (125)
Male rotatable VCR face seal fitting			4.0 (113)
Male integral VCR face seal fitting		1.88 (47.8)	

Pressure Range Designators

Pressure Range, psi (bar)			Pressure Range, MPa		
Minimum	Maximum psi (bar)	Pressure Range Designator	Minimum	Maximum MPa	Pressure Range Designator
–30 in. Hg (–1 bar)	15 (1)	C15	–0.1 MPa	0.1	C01
	30 (2)	C30		0.2	C02
	60 (4)	C60		0.4	C04
	100 (6.8)	C100		0.7	C07
	200 (13.6)	C200		1.1	C11
0 psi (0 bar)	15 (1)	15	0 MPa	0.1	01
	30 (2)	30		0.2	02
	60 (4)	60		0.4	04
	100 (6.8)	100		0.7	07
	160 (11)	160		1.1	11
	200 (13.6)	200		1.4	14
	300 (20)	300		2.1	21
	600 (40)	600		4.0	40
	1000 (68)	1000		7.0	70
	3000 (200)	3000		21	210

Center Back Mount Gauges

2 in. (50 mm) Center Back Mount Gauge Dimensions

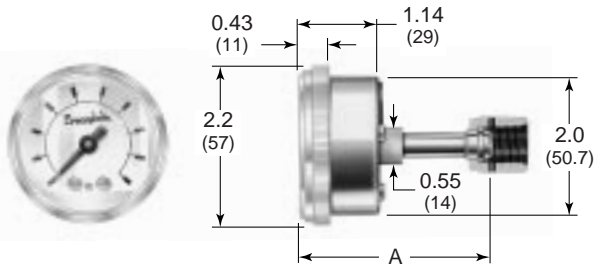

End Connection		Dimensions, in. (mm)		Weight, oz (g)
Type	Size	A		
Female VCR face seal fitting	1/4	2.80 (71)		4.75 (135)
Male rotatable VCR face seal fitting				4.5 (128)
Male integral VCR face seal fitting		2.23 (56.6)		

Pressure Range Designators

Pressure Range, psi (bar)		
Minimum	Maximum, psi (bar)	Pressure Range Designator
-30 in. Hg (-1 bar)	15 (1)	C15
	30 (2)	C30
	60 (4)	C60
	100 (6.8)	C100
	160 (11)	C160
0 psi (0 bar)	30 (2)	30
	60 (4)	60
	100 (6.8)	100

Pressure Range, MPa		
Minimum	Maximum, MPa	Pressure Range Designator
-0.1 MPa	0.2	C02
	0.4	C04
	0.7	C07
	1.1	C11
	1.4	C14
0 MPa	0.2	02
	0.4	04
	0.7	07

1 1/2 in. (40 mm) Center Back Mount Gauge Dimensions

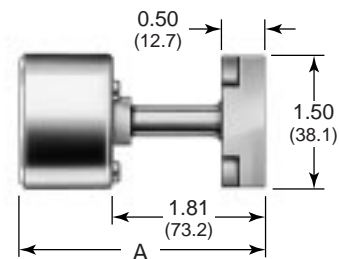
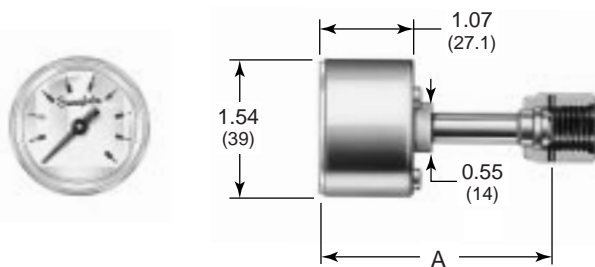

End Connection		Dimensions, in. (mm)		Weight, oz (g)
Type	Size	A		
Female VCR face seal fitting	1/4	2.57 (65.3)		3.36 (95)
Male rotatable VCR face seal fitting				3.28 (93)
Surface mount	1 1/2	2.88 (73.2)		6.0 (170)

Pressure Range Designators

Pressure Range, psi (bar)		
Minimum	Maximum, psi (bar)	Pressure Range Designator
-30 in. Hg (-1 bar)	30 (2)	C30
	60 (4)	C60
	100 (6.8)	C100

Pressure Range, MPa		
Minimum	Maximum, MPa	Pressure Range Designator
-0.1 MPa	0.2	C02
	0.4	C04
	0.7	C07

Ordering Information

Create a gauge ordering number by adding the designators as shown below.

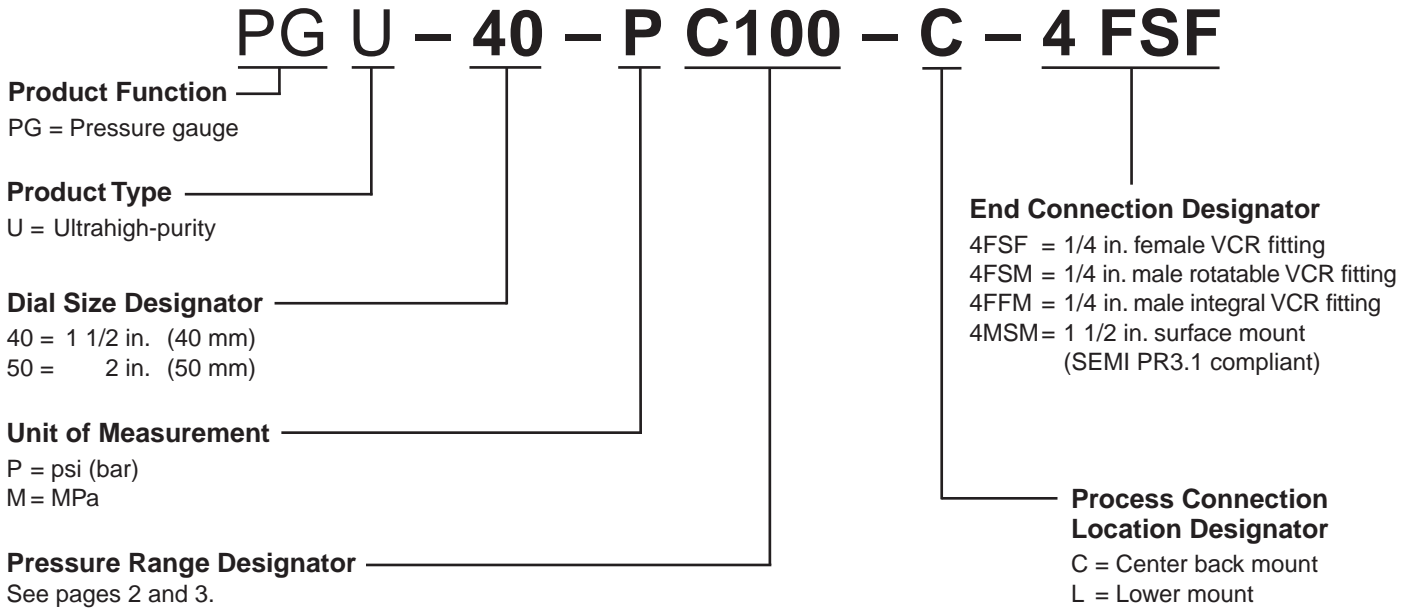

Options and Accessories

The front flange and U-clamp options are used to secure a 2 in. (50 mm) center back mount gauge to a panel.

Front Flange

Using the front flange, the gauge is inserted through the front of the panel. Screws are used to secure the flange to the face of the panel.

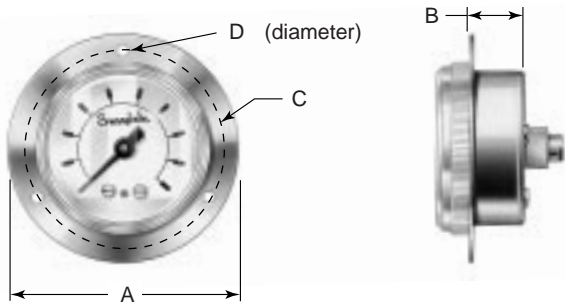

U-Clamp

The gauge is inserted into the flange of the U-clamp, and this assembly is inserted through the face of the panel. The U-clamp is tightened from behind the panel so that the back of the flange is flush against the front of the panel. The panel hides mounting hardware, and no holes are visible on the front of the panel.

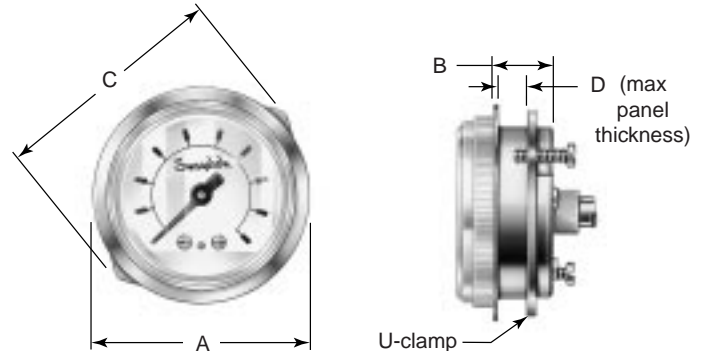

Ordering Information / Dimensions

Description	Ordering Number	Dimensions, in. (mm)			
		A	B	C	D
Front flange	SS-50PG-FF	3.00 (76.2)	0.73 (18.6)	2.57 (65.4)	0.14 (3.6)
U-clamp	SS-50PG-UC	2.63 (66.4)	0.73 (18.6)	2.79 (71)	0.38 (9.8)

Safe Product Selection

When selecting a product, the total system design must be considered to ensure safe, trouble-free performance. Function, material compatibility, adequate ratings, proper installation, operation, and maintenance are the responsibilities of the system designer and user.

Caution: Do not mix or interchange parts with those of other manufacturers.

Northeast Controls Inc. sales@northeastcontr
 Serving Industry Since 1937 201.327
201.327
Ques

SEE PRODUCTS | SEARCH US | GET HELP | GET PRICING | RESOURCES HOME | CON

Dwyer Series VF Visi Float Flowmeters



Series VF Visi-Float Flowmeters

Precision machined from solid acrylic-Used to indicate or manually control air or gas flow from .1 SCFH to 100SCFM... water from.6 GPH to 20 GPM

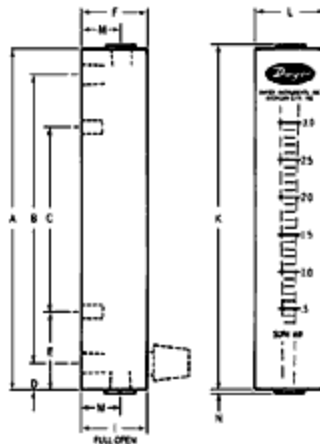

Dimensional Enlargement

Dwyer Visi-Float flowmeter bodies are cut and precision machined from solid, clear acrylic plastic blocks. This construction not only produces a handsome finished product, but permits complete visual inspection. As a result, the Dwyer Visi-Float flowmeters are especially popular for medical and laboratory equipment applications.

Scales are easy to read - The front scale location and white background provides excellent visibility. The direct reading scales are hot stamped into the plastic and will not wear off. Mid-range calibration is established with a master flowmeter. Accuracy is $\pm 5\%$ of full scale for VFA models, $\pm 3\%$ for VFB, and $\pm 2\%$ for VFC. Scales average 2" long on the VFA models, 4" long on VFB, and 5" long on VFC.







Durable and attractive construction - The machined acrylic bodies of the Dwyer Visi-Float flowmeters are practically unbreakable. Fabrication is backed by over 60 years of experience in acrylic instrument machining. The tapered bore is precision machined to a smooth surface that provides perfect visibility of the indicating float. The VFA and VFB models are available with either brass or stainless steel inlet and outlet connections and are tapped for 1/8" NPT Thread. VFB models 85 and 86 have either 1/4" back or 3/8" end connections. The VFC models have PVC 1" NPT female connections and VFCII units are equipped with acetal thermoplastic 1" NPT male fittings. VFCII fittings also include hex wrench flats to prevent stripped threads. All standard models employ Buna-N "O" rings for leak proof operation and are available with either back or end connections for horizontal or vertical piping. Precision metering valves in brass or stainless steel are available for most VFA and VFB models. VFC

models, intended for use with external metering valves, include a stainless steel guide rod and large diameter float for excellent stability and visibility at higher flow rates. Two options are offered for VFCII units, specifically designed for applications requiring FDA approved materials. Choose 316 stainless steel float and guide rod and Viton® "O" rings. See OPTIONS for ordering codes.

Easy installation - All Visi-Float flowmeters have metal mounting inserts on rear for panel mounting. They can also be supported directly by system piping.

 <p>Special Multi-Column Visi-Float Flowmeters</p>	<p>For the OEM product designer, multi-column flow meters can be custom made in an almost infinite variety of combinations. Up to 10 columns can be machined from a single block of acrylic with scale lengths up to 4" long and accuracies to ±3% of full scale. Brass or stainless steel fittings are available. Flow rates can be controlled with metering or on-off valves. Customer logos can be hot stamped on the face of these units in any color. Consult the factory regarding your special requirements.</p>
--	---

VIEW CHARTS

- Use Drop Menu To Find Other Products 
- Use Drop Menu To Find Other Products 
- Use Drop Menu To Find Other Products 
- Use Drop Menu To Find Other Products 
- Use Drop Menu To Find Other Products 
- Use Drop Menu To Find Other Products 

[NY Office](#) | [Contacts](#) | [Payment Terms](#) | [Services](#) | [About Us](#) | [Products](#) | [Search](#) | [Help](#) | [Transit](#)

Tel: 201.327.7660 | Fax: 201.327.3242 | sales@northeastcontrolsinc.com

P.O. Box 275 - 123 Pleasant Avenue - Upper Saddle River, New Jersey 07458 USA

Copyright © 2001 [Northeast Controls Inc.](#)

Warning: We digitally embed all pictures with our company watermark to prevent copyright infringement. The watermark is not visible to the "naked" eye. Pictures may not be used commercially without our written authorization. This site is designed for Internet Explorer 4.0+ and Netscape Navigator 6.0+



[Home](#)
[About Us](#)
[Pressure and Vacuum Switches](#)
[Magnetic Heads](#)
[Sales Representatives](#)
[FAQs](#)
[Site Map](#)
[Request Info/Quotation](#)
[Meet Our People](#)
[Recommend Our Web Site!](#)
[Need a word defined?](#)

[Visit our Glossary of Terms!](#)

DesignFLEX™ PSF103 Series

High Current Pressure/Vacuum Switch

[[Features](#)] - [[Specifications](#)] - [[Example Drawing](#)] - [[Ordering Guide](#)]

After reviewing the features and specifications below, click on "Ordering Guide" and build your own custom switch. Then click on "Request Information/Quotation" and send us your request for quote.

FEATURES

- Hysteresis (deadband) for compressor or refill motor control
- Field adjustable pressure set point, from 2" H₂O to 60 PSI
- Snap action basic switch, up to 25 A, 125/250 VAC
- Variety of pressure port options
- Small size and lightweight



SPECIFICATIONS

MECHANICAL

Switch Type	SPDT normally open or normally closed
Switching Medium	Air or compatible fluids
Mechanical Life	More than 10 million cycles
Proof Pressure	See chart
Weight	Less than 20 grams
Operating Temp.	+40 deg F to + 150 deg F (standard) -46 deg F to +205 deg F (consult factory)

PHYSICAL

Mounting	Use #4 screws thru mounting lugs or #2 screws thru eyelets
Case Material	Polycarbonate standard
Contact Material	Silver (Gold available on special order)
Diaphragm Material	Polyurethane standard
Electrical Connections	Terminals - .187" x .020" tab-type for use with quick disconnects (ref. AMP #2-520182-2 or equivalent)

EXAMPLE DRAWING

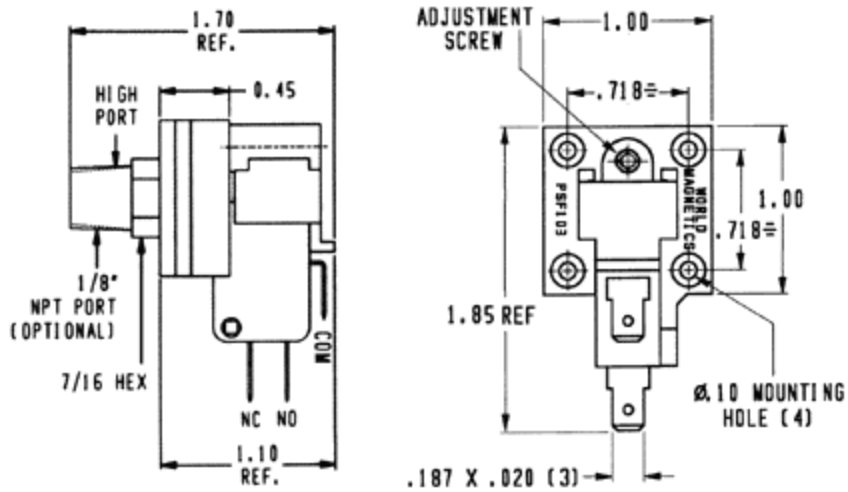

ORDERING GUIDE











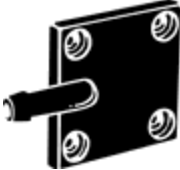

DesignFLEX™ Options: Determine a Part Number by choosing from the options below, then arranging the option numbers in this sequence:

PART NUMBER	9				-		
	PSF103 Series	<u>Pressure Cover/Port</u>	Diaphragm: 1. Polyurethane (standard) 2. Teflon			<u>Pressure Set Point</u>	

Example: Part # 9 0 1 2 - 9 0 2

- PSF103 Series
- Smooth Port .156" Diameter for 1/8" ID Tubing w/o Mtg. Lugs
- Teflon Diaphragm
- Adjustable Set Point Range: 2 to 10 inch H₂O

High Port / Housing Options			

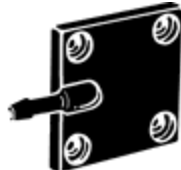
			
00. Smooth Port .156" Diameter for 1/8" ID Tubing w/Mtg. Lugs	01. Smooth Port .156" Diameter for 1/8" ID Tubing w/o Mtg. Lugs	02. Barbed Port for 3/16" ID Tubing Same Side as Terminals w/Mtg. Lugs	03. Barbed Port for 3/16" ID Tubing Opposite Terminals w/Mtg. Lugs
			
04. Barbed Port for 3/16" ID Tubing Same Side as Terminals w/o Mtg. Lugs	05. Barbed Port for 3/16" ID Tubing Opposite Terminals w/o Mtg. Lugs	06. 1/8" NPT Port w/o Mtg. Lugs	07. Flow-Thru Barbed Port for 1/8" ID Tubing w/o Mtg. Lugs
			
08. Smooth Port .250" Diameter for 7/328" ID Tubing w/o Mtg. Lugs	09. Smooth Port .250" Diameter for 7/328" ID Tubing w/Mtg. Lugs	10. Barbed Port for 1/8" ID Tubing Same Side as Terminals w/Mtg. Lugs	11. Barbed Port for 1/8" ID Tubing Opposite Terminals w/Mtg. Lugs
			
	12. Barbed Port for 1/8" ID Tubing Same Side as Terminals w/o Mtg. Lugs	13. Barbed Port for 1/8" ID Tubing Opposite Terminals w/o Mtg. Lugs	

[Return to Ordering Guide](#)

ADJUSTABLE PRESSURE SET POINT OPTIONS						
OPTIONS	IN. H ₂ O	mbar	PSI	Proof Pressure		Electrical 125/250 VAC
				Polyurethane	Teflon	

902	2 - 10	5 - 25	0.1 - 0.4	30 PSI	15 PSI	3A
903	10 - 28	25 - 69	0.4 - 1.0	30 PSI	15 PSI	10A
904	28 - 111	69 - 276	1.0 - 4.0	30 PSI	15 PSI	15A
905	111 - 416	276 - 1034	4.0 - 15.0	100 PSI	30 PSI	15A
906	416-1664	1034-4137	15.0-60.0	100 PSI	30 PSI	15A

[Return to Ordering Guide](#)

[Home](#) · [About Us](#) · [Pressure/Vacuum Switches](#) · [Magnetic Heads](#)

[Sales Representatives](#) · [FAQs](#) · [Site Map](#) · [Request Information/Quotation](#)

World Magnetics

810 Hastings Street
Traverse City, MI 49686 USA
PHONE: 231-946-3800
FAX: 231-946-0274

E-Mail: info@worldmagnetics.com

Copyright © 2002 World Magnetics

Web Site Design and Maintenance by

