

varian 

vacuum products

121 Hartwell Avenue
Lexington, Massachusetts 02173
(617) 861-7200

SD 40 Rotary Vane Pump

Instruction Manual

Manual No. 699904440
Revision 1
October 1998





**Health and Safety Clearance
 Return Authorization Policy**

In compliance with Federal OSHA Safety Standard 1910.1200, Hazard Communications «Right to Know», Varian is enforcing that standard to preclude the potential health risk to its service personnel that can occur when receiving, disassembling, or repairing potentially contaminated products.

Returned products not accompanied by this completed certificate will be held until the completed certificate is received; failure to provide this completed certificate within 30 days of notification will result in the return of held product(s) **unprocessed**.

If a product is received at Varian in a contaminated condition, the customer will be held responsible for all costs incurred to ensure the safe handling of the product.

Company Name: _____

_____ Hereby certify that the product(s) listed below have been cleaned of all hazardous residue and that the residue remaining is of a non-hazardous nature.

_____ Hereby certify that the product(s) listed below have been contaminated by the following toxic or hazardous materials:

RA Number	Model Number	Serial Number
_____	_____	_____

_____	_____	_____
Authorized Signature	Title	Date

Note: Varian Service will only accept contaminated **Turbo or Mechanical Pumps**. All other products must be decontaminated by the customer before Varian Vacuum Products Lexington will assign a Return Authorization (RA) number and authorize the return of the product (refer to the attached Return Authorization Report on the next page).

Note: **Varian Vacuum Products Lexington cannot accept any biological hazards, radioactive material, organic metals, or mercury at its facility.**

Table of contents

Warranty	3
Features	7
Safety instructions	8
Operating principle	11
Technical characteristics	16
Accessories	20
Start-up	21
Electrical connections	24
Mechanical connections	26
Maintenance	28

Warranty

Products manufactured by Seller are warranted against defects in materials and workmanship for twelve (12) months from date of shipment thereof to Customer, and Seller's liability under valid warranty claims is limited, at the option of Seller, to repair, replacement, or refund of an equitable portion of the purchase price of the Product. Items expensable in normal use are not covered by this warranty. All warranty replacement or repair of parts shall be limited to equipment malfunctions which, in the sole opinion of Seller, are due or traceable to defects in original materials or workmanship. All obligations of Seller under this warranty shall cease in the event of abuse, accident, alteration, misuse, or neglect of the equipment. In warranty repaired or replacement parts are warranted only for the remaining unexpired portion of the original warranty period applicable to the repaired or replaced parts. After expiration of the applicable warranty period, Customer shall be charged at the then current prices for parts, labor, and transportation.

Reasonable care must be used to avoid hazards. Seller expressly disclaims responsibility for loss or damage caused by the use of its Products other than in accordance with proper operating procedures.

When products are used with toxic chemicals, or in an atmosphere that is dangerous to the health of humans, or is environmentally unsafe, it will be the responsibility of the Customer to have the product cleaned by an independent agency skilled and approved in handling and cleaning contaminated materials before the product will be accepted by Varian Associates for repair and/or replacement.

Except as stated herein, Seller makes no warranty, express or implied (either in fact or by operation of law), statutory or otherwise; and, except as stated herein, Seller shall have no liability under any warranty, express or implied (either in fact or by operation of law), statutory or otherwise. Statements made by any person, including representatives of Seller, which are inconsistent or in conflict with the terms of this warranty shall not be binding upon Seller unless reduced to writing and approved by an officer of Seller.

Warranty Replacement and Adjustment

All claims under warranty must be made promptly after occurrence of circumstances giving rise thereto, and must be received within the applicable warranty period by Seller or its authorized representative. Such claims should include the Product serial number, the date of shipment, and a full description of the circumstances giving rise to the claim. Before any Products are returned for repair and/or adjustment, written authorization from Seller or its authorized representative for the return and instructions as to how and where these Products should be returned must be obtained. Any Product returned to Seller for examination shall be prepaid via the means of transportation indicated as acceptable by Seller. Seller reserves the right to reject any warranty claim not promptly reported and any warranty claim on any item that has been altered or has been returned by non-acceptable means of transportation. When any Product is returned for examination and inspection, or for any other reason, Customer shall be responsible for all damage resulting from improper packing or handling, and for loss in transit, notwithstanding any defect or non-conformity in the Product, in all cases, Seller has the sole responsibility for determining the cause and nature of failure, and Seller's determination with regard thereto shall be final.

If it is found that Seller's Product has been returned without cause and is still serviceable, Customer will be notified and the Product returned at its expense; in addition, a charge for testing and examination may be made on Products so returned.

Welcome

SD 40 pump

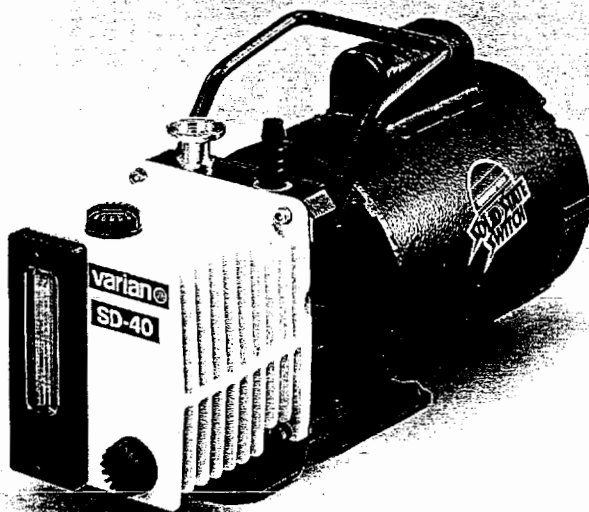

When you purchase a Varian SD series rotary vane pump, you purchase the extensive knowledge of the people who make up VARIAN.

These are the same people who provide you with the technical support on your most complex and demanding applications.

APPLICATIONS:

- RESEARCH AND DEVELOPMENT
Physics and chemistry laboratories, etc.
- INDUSTRY
Foodstuffs (freeze-drying), Pharmaceuticals,
Electronic tube manufacture,
Metallurgy, Drying systems,
Refrigeration systems, Chemical industry, etc.
- INSTRUMENTATION
Mass spectrometry, Centrifuges,
Electronic microscopes, Leak detection systems, etc.

 We suggest that you read this manual, particularly the chapter on installation and operation, before you start to use this pump so that you can obtain optimum levels of performance and complete satisfaction from this equipment.

Features

1.4 CFM rotary vane pumps. SD 40

The series 40 pump model is specially designed for integration into portable or compact systems (spectrometers, analyzers, leak detectors...). It presents the following main characteristics:

- A **direct drive motor**, making it very compact.
- An electrically insulated **handle** is used for easy carrying.
- An **anti-suckback system** ensures the tightness of the pump during accidental or voluntary shutdowns.
- A **gas ballast** enables the pumping of condensable vapours.
- The single-phase **motor** can be disassembled **independently** of the rest of the pump, without the need to drain the oil case.
- On the oil case, a **vertical sight glass** can be used to inspect the oil level easily when filling the tank and during the operation of the pump.

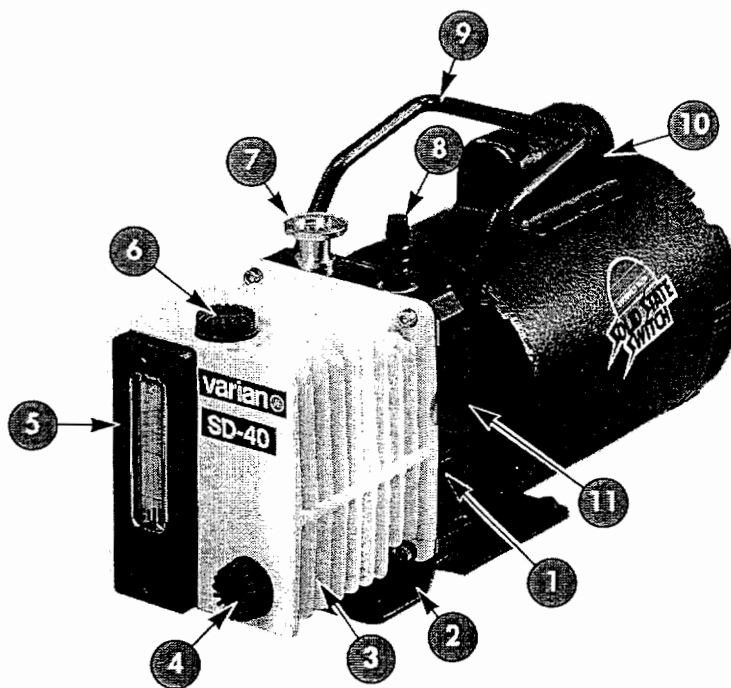

- | | |
|--------------------------|------------------------|
| 1. Central housing | 7. Inlet fitting |
| 2. Base | 8. Exhaust end fitting |
| 3. Oil case | 9. Fold-away handle |
| 4. Draining plug | 10. Electric motor |
| 5. Oil level sight glass | 11. Gas ballast |
| 6. Filling plug | |

The inlet fitting is PNEUROP ISO-KF standardized. It is fitted vertically on the pump at delivery. It can also be used to connect our accessories (*see page 20*). The exhaust fitting is a 10 mm hose nipple.

The main replacement parts are interchangeable. This enables easier disassembly-assembly operations and replacement without changing the pump's performance.

Various accessories can be used to adapt the pump to meet the requirements of your application.

The moulded aluminium pump frame supports the pumping module and the motor. All the parts of the pumping module in contact with gases are free of zinc, copper and cadmium.

The other construction materials include cast iron, aluminium alloy, stainless steel, fluorocarbons, nitril (NBR) and chemically resistant polymers.

Safety instructions

Safety instructions concerning the installation and operation of pumping systems



Before switching on the equipment, the user must read all of the start-up and operation sections of this manual and observe the safety instructions listed in the booklet of declarations of compliance supplied with the unit.

Unpacking

When you receive the equipment, unpack it carefully. Do not discard the packaging until you have ensured that the pump has not been damaged during transport. Otherwise, take the necessary measures with the transporting company and, if necessary, notify VARIAN.

For all handling, only use the devices provided for this purpose (lifting rings, handle, etc.).

The pump is not supplied filled with oil. The oil is contained in separate bottles. Similarly, it is recommended to drain the pump before redispaching the equipment.

Storage

- If the pump is to be stored, we guarantee the reliability of our equipment without particular storage precautions for up to 3 months (ambient temperature between 41°F and 149°F or 5 and 65°C).

- For storage periods of over 3 months, we recommend to fill the pump with oil during storage. For this, fill the pump and run it at ultimate vacuum (inlet orifice blocked) for approximately 1 hour in order to lubricate all the parts of the functional block (*see page 21*).

Then, stop the pump and store it with the inlet and exhaust orifices sealed: clamping ring, centring ring, plug, etc.

The shaft should be rotated by hand or by starting the pump every six months following this storage procedure.

- After 6 months storage without oil, factors such as temperature, degree of humidity, salt air, etc. may cause the deterioration of the pump components, particularly the hardening of O-rings and the "sticking" of lip seals on shafts and the gumming of oil. In this state, a pump may have operational problems, particularly oil leaks. Before any start-up (new pump as well as used), the pump must be disassembled (*see page 34*), and all the seals changed.

Note 1:

The seal kits must be stored with caution. Keep them away from heat and light (sunlight and ultraviolet light) in order to prevent the elastomers from hardening.

Installation and start-up

- The machines must be connected to an electrical installation in compliance with decree 88-1056 dated 14th November 1988, as well as any local electrical codes that apply.
- It is important to isolate the machine from the power source before any intervention on the equipment (for maintenance purposes).
- When switching off the power of equipment containing capacitors loaded with over 60 VDC or 25 VAC, take precautions when accessing the connector pins (single-phase motors, equipment with mains filter, frequency converter, monitor, etc.).
- Vane roughing pumps use lubricants, it is recommended to request information from the manufacturer on the safety data sheets concerning the product used.
- Our pumps are designed to prevent any thermal risk for user safety. However, specific operating conditions may generate temperatures which may justify particular attention on the part of the user (outer surfaces > 70°C or 158°F).

Oxygen pumping

In certain applications, mixtures containing oxygen at different concentrations, or even pure oxygen, are used.

Oils of mineral origin are combustible. Exposure to pure oxygen at high temperatures may cause them to self-ignite. In addition, they are highly oxidized during pumping and quickly lose their lubricating properties. Mineral oils must not be used for oxygen levels of over 21 % in pumped gases. In this case, perfluorinated synthetic oils must be used, see list on **page 18**.

The use of these oils requires a special pump preparation (**see page 33**).

The pump must be completely disassembled and all traces of mineral oil removed. Flushing the oil case is not adequate.



In addition, it is strongly recommended not to use fluids such as tri-aryl-phosphate-ester which are known to cause accidents.

Any accumulation of oxygen in the installation should be avoided and the oxygen or combustible mixture should be diluted with an inert gas at the exhaust: the gas flow rate should be 4 times the oxygen flow rate.

Certain combustible or explosive gases require a higher degree of dilution. Our International Support Services and Customer Services can advise you to help solve problems of this kind.

Operating principle

Oil

Its function

Oil has several important functions in the pump:

- It lubricates mechanical components (bearings, seals, rotor, vanes, etc.).
- It makes moving parts relatively tight by limiting internal leakage.
- It carries away the heat produced by the compressed gases.

Choosing the right oil

Not all oils produce the same ultimate pressure in a given pump.

Ultimate pressure depends on the saturated vapour pressure of the oil, its viscosity and its ability to dissolve gases.

Good pumping conditions are related to the type of oil used.

The choice depends on:

- Expected pump performance.
- Chemical aggression and corrosion of pumped gases.
- Accessories used.
- Desired maintenance intervals and total operating cost.

VARIAN has selected two types of oil for its pumps (*see page 18*).

Lubrication and anti-noise device

The pump is equipped with a **lubrication** system which regulates the oil flow rate required in the vacuum pump. In addition this system also ensures the gassing of the lubrication oil and therefore **the low noise level** of the pump.

Gas ballast

When condensable vapours are being pumped, gas is compressed beyond its saturated vapour pressure in the "compression" phase and can condense, impairing pump performance.

The gas ballast can be used to inject a certain quantity of air (neutral or dry gas) into the last stage of the pump

during the "compression" phase so that the partial pressure of the pumped gas is less than its saturated vapour pressure at the temperature of the pump.

Condensation is therefore impossible if this limit is not reached.

The maximum admissible vapour pressure is obtained at pump inlet for this value.

At the end of "compression", the pressure in the exhaust chamber is greater than atmospheric pressure. An anti-suckback device (valve + spring) prevents the gases and oil from being discharged to the outside via the inlet.

The saturated vapour pressure of a body is higher when the system is hot than when it is cold; therefore, the pump must reach operating temperature before pumping condensable vapours.

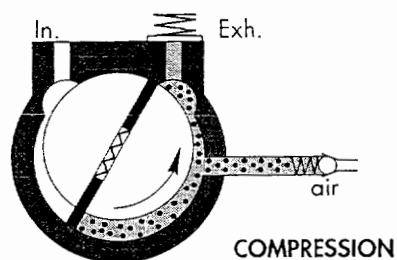

- Using the gas ballast increases the ultimate pressure of the pump as well as the temperature.

- The gas ballast control, located at the side of the housing cannot be used to set the gas injection flow rate.

- When the gas ballast control is open, the pump is not tight when stopped.

To guarantee this tightness, install an automatic gas ballast.

Operating principle of the rotary vane pump

Rotary vane pump principle

This is a volumetric pump, with two functional stages, each composed of:

- A hollow cylindrical stator with inlet and exhaust valves.
- A rotor mounted eccentrically inside the stator for pumping.
- Two vanes sliding in the rotor, forced against the stator by centrifugal force and springs.

The pumping cycle is given below for each stage:

Inlet

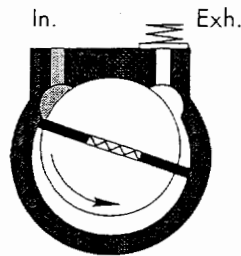

As the vane passes in front of the inlet orifice, an increasing space is formed into which the gas from the chamber to be evacuated expands. When the second vane passes, the space is closed.

Transfer

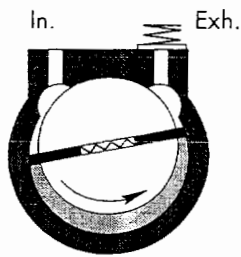

The gas trapped in the space between the two vanes is transferred to the exhaust orifice as the rotor rotates.

Compression

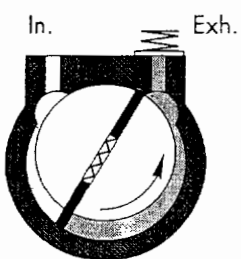

The space communicates with the exhaust, which is fitted with a valve: the gas is compressed until the safety valve is opened.

Exhaust

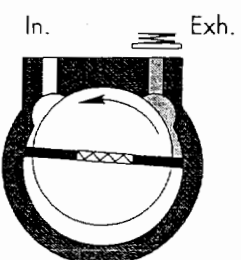

The gas is expelled into the oil casing when the pressure is sufficient to open the valve.

Two-stage rotary vane pump

To improve the backing pressure and flowrate at low pressure, two stages are connected in series. The second is similar to the first both structurally and operationally. The gases pulled in by the first (low pressure) stage are transferred to the second (high pressure) stage and discharged through the high pressure (HP) valve.

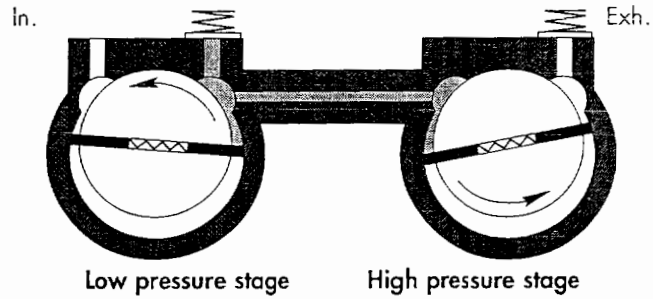

Application

Two stage rotary vane pumps are the best choice for application requiring an ultimate vacuum as low as 10^{-3} Torr (1.33×10^{-3} mbar).

Note : when operating a two stage vane pump continuously, greater than half an hour, above 1.0 Torr (1.3 mbar), the unit should be equipped with an oil mist eliminator.

Please, contact Varian if your application operates for more than half an hour above 1.0 Torr (1.3 mbar).

Regeneration of pump oil

In a pump stored with the same oil for a long time, condensed vapours may contaminate the oil bath and affect performance. This is also the case after pumping vapours and when the oil appears cloudy or discolored through the sight glass.

- Run the pump, shutting it off from the system at the inlet by a valve or a plug.
- Open the gas ballast and allow the pump to operate for 1/2 hour to 1 hour, or longer if the oil remains cloudy. This operation accelerates the temperature rise of the pump while eliminating residual vapours present in the oil bath.

Pumping condensable vapours

To pump with condensable products, it is necessary to operate with a hot pump. For this, isolate the pump from the system and allow it to operate for 1/2 hour with the gas ballast open, or 1 hour (if possible) with the gas ballast closed. When the oil bath is hot, the condensation of vapours in the pump is reduced or prevented.

Choice of pump and system

The pump's capacity to eliminate condensable vapours is related to their type, the pump temperature and the quantity of air introduced by the gas ballast. Care should be taken to limit the inlet pressure of the pump to its maximum admissible water vapor pressure.

The use of cold traps or condensers are recommended when large quantities of vapours are to be extracted. Excessively intense or prolonged pumping may cause the products condensed in the trap to be evaporated a second time.

Choice of oil

Choose an oil which facilitates the separation of pumped products which may be condensed in the oil bath (anti-emulsion oil for water-based compounds, etc.) (*see page 18*).

Assembly

The condensation of vapours at the pump exhaust is reduced if:

- the pump and oil temperature are high;
- the pressure at the exhaust is as low as possible (removal of the oil mist eliminator...);
- the condensates are collected separately from the oil bath and do not block the exhaust duct.

For this:

- avoid using any vertical ducting which promotes the condensation of products and the return of these products to the pump.

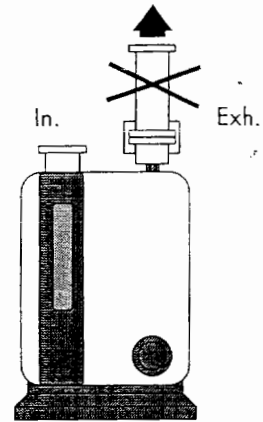

- use a condensate collector;
- we do not recommend an oil mist eliminator when pumping condensable vapors: if it is essential, do not connect it directly to the pump exhaust but place it outside the condensation zone.
- if possible, connect the exhaust to a mechanical device creating a negative pressure from 0.1 to 0.2 bar.

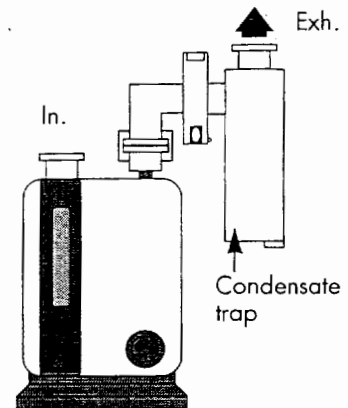

Vapor pumping procedure

- Valve off the pump from the system and increase the pump temperature, 30 minutes with gas ballast (*see page 14*).
- Start pumping and check the oil level:
 - The level drops, oil is being lost;
 - The level rises, condensates have been added to the oil.
- After pumping, regenerate the oil using gas ballast if it is cloudy or discoloured.
 - if the level is too high, change the oil and regenerate.
- Change the oil as soon as inlet pressure characteristics drop and are not improved by regeneration.

Technical characteristics

Presentation of the product range

A wide range
Specific solutions adapted to various applications

Varian oil seal rotary vane pumps are used in many vacuum technology applications.

They can be used on their own to achieve a maximum vacuum of 10^{-3} Torr (10^{-3} mbar), or in pumping assemblies, e.g. at the exhaust of a diffusion pump or turbomolecular pump.

SD series

Standard pump for several purposes (non-corrosive applications).
Pump designed to meet the requirements of analytical instrumentation and R&D.
Mass spectrometer, electronic microscopes, GC/MS, LC/MS, gas analysers, leak detectors, sterilizers, etc.

Technical characteristics

SD Model

Characteristics	Unit	SD 40	
Frequency	Hz	50	60
Number of stages		2	
Rotation speed	rpm	3000	3600
Nominal flow rate	m ³ /h cfm	2	2.4 1.4
Flow rate Pneurop method	m ³ /h cfm	1.6	2.2 1.1
Ultimate pressure with gas ballast closed	Torr/mbar Pa	$2.3 \times 10^{-3} / 3.10^{-3}$ 3.10 ⁻¹	
Ultimate pressure with gas ballast open	Torr/mbar Pa	$2.3 \times 10^{-2} / 3.10^{-2}$ 3	
Oil capacity	l	0.35	
Maximum water vapour pumping capacity	Torr/mbar Pa	22.5/30 3.10 ³	
Water vapor pumping capacity	g/h	36	35
Weight (pump + motor)*	lbs (kg)	26.4 (12)	
Inlet fitting	ISO-KF	DN 16	
Exhaust fitting	mm	Ø 10	

* These values are for pumps equipped with single-phase motors.

Note: The pressure measurements were made with a capacitive diaphragm pressure gauge measuring a total pressure in the absence of a cold trap. Measurements using a Pirani type gauge can give different pressure values.

Table of recommended oils

Recommended oils

In the vane pumps, we recommend to use only the VARIAN oils in the table below:

OIL	APPLICATION	Total ultimate pressure* (mbar)	Viscosity mm ² /s (cst)	Vapour tension 25°C (mbar)	Flash point/ self-ignition temperature
GP	Mineral oil distilled under vacuum - Pumping non-corrosive products - Low viscosity	≤ 3.10 ⁻³	40°C/54 100°C/8.1	< 4.10 ⁻⁵	213°C 244°C
CS	Mineral oil distilled under vacuum: - Pumping corrosive products - Low backstreaming	≤ 2.10 ⁻²	40°C/58 100°C/8.5	< 1.10 ⁻⁵	223°C 259°C

* Ultimate pressure measured according to Pneurop 6602 specifications on SD 40 pump.

These values are given as a rough guide only. They may vary according to the type of pump and the pumping conditions.

 Requires special preparation of pump (see page 33).

Pump dimensions
Inch (mm)

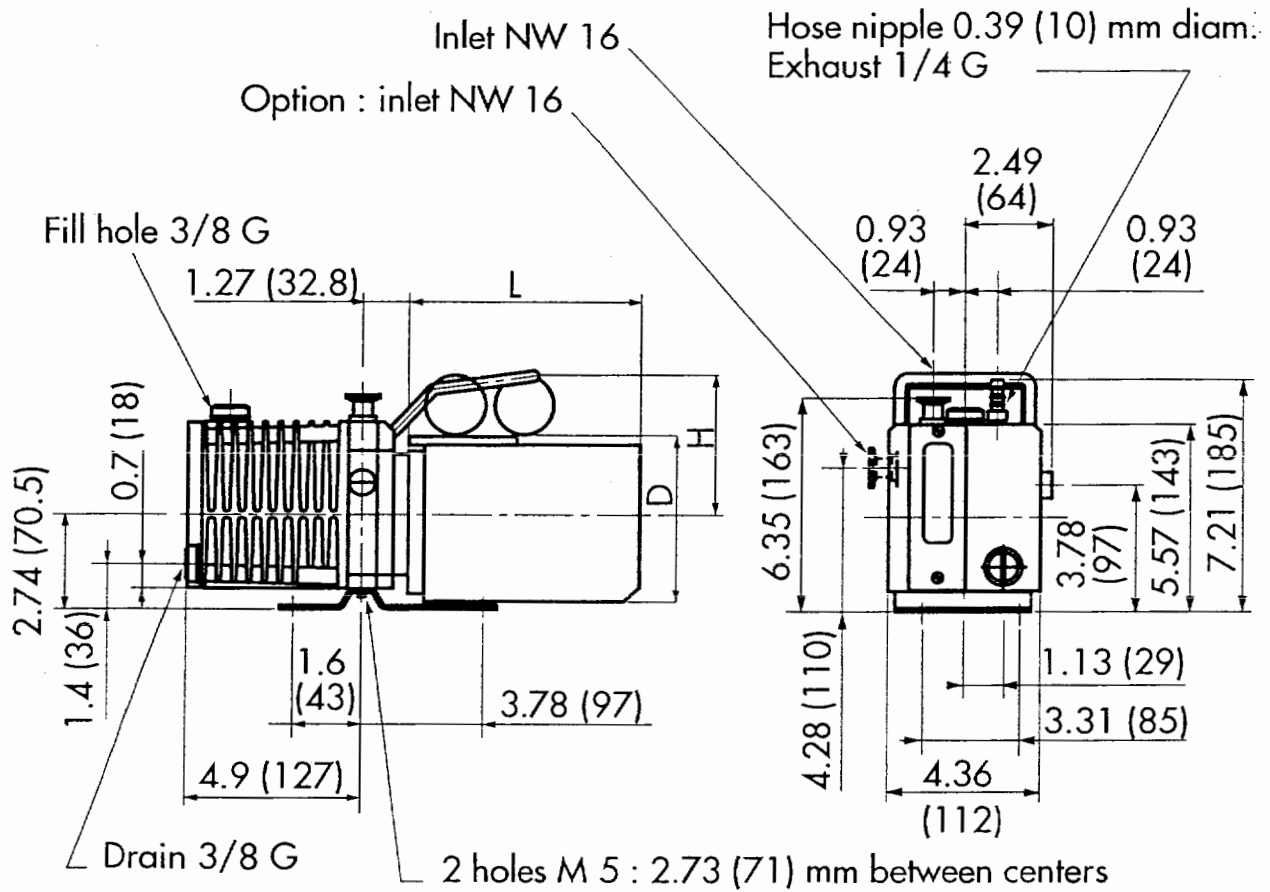

Dim.	According to motors	
Inch (mm)	Minimum	Maximum*
L	6.5 (164)	7.8 (198)
D	5.4 (136)	5.5 (140)
H	3.7 (93)	4.3 (108)

* Specific for motor Franklin

Accessories

NAME	PART NUMBER	LOCATION	FUNCTIONS
Oil mist eliminator OME SD 40	P 1137301	Exhaust	<ul style="list-style-type: none"> • Separates oil droplets and particles contained in exhaust gases emitted by the pump.
Dust filter DFT 25 *	P 1127301	Inlet	<ul style="list-style-type: none"> • Prevents dust particles larger than 6 microns from entering the pump.
Liquid nitrogen trap LNT 25 S *	P 1118301	Inlet	<ul style="list-style-type: none"> • Protects the pump against condensable vapours. • Prevents oil from backstreaming into pumped chamber.

* Use a DN 16 / DN 25 reducer to connect this accessory.



In general, use accessories in which the tightness and materials are compatible with the pumped gases and the required safety conditions at both the inlet and the exhaust.

At the pump exhaust, the discharge circuit must be such that the resulting excess pressure in the oil case is as low as possible.

The maximum excess pressure recommended for correct pump operation is 0.5 bar (6 PSI).

A slight negative pressure in the oil case (0.1 to 0.2 bar / 1.5 PSI), at the exhaust, will prevent gases from accumulating and reduce pump corrosion and pollution.

Start up

Filling with oil

Use **GP** or **CS** type oil.

At delivery, there is some oil in the functional block.

Our pumps are tested in the factory with VARIAN oil: it is recommended to use the same oil during operation. To change the type of oil, refer to the Maintenance Chapter, "replacement of type of oil" section.

 **In all cases, follow the recommendations of the pump specifier for the choice of oil to be used.**

If necessary, carry out the special preparation procedure for the pump, then, remove the filling cap and fill with oil until the oil reaches the highest mark on the sight glass.

This operation must be performed with the pump switched off.

Filling plug

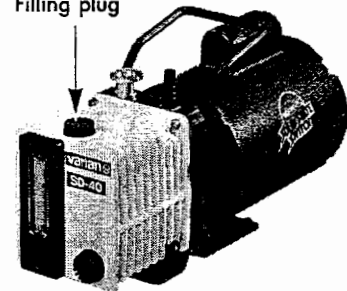

Checking the oil level

To use the pump in optimum conditions, the oil level must be observed and checked regularly. This level is checked with the pump switched off, hot and on a horizontal plane.

Note: Optimum pump performance and service life are obtained when the oil level is between the maximum level and the minimum level.

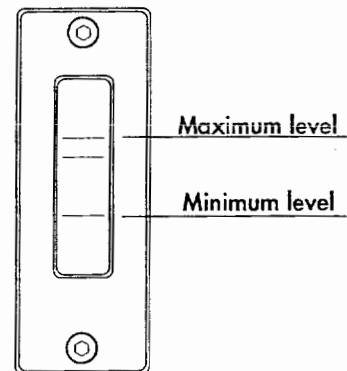

Preliminary precautions



- The performance and operating safety of this product can only be guaranteed if it is operated according to normal conditions of use.
- The vacuum pump is also a compressor; incorrect operation may be dangerous. Study the user manual before starting up the pump.
- The pumps are designed to prevent any thermal risk for user safety. However, specific operating conditions may generate temperatures which may justify particular attention on the part of the user > 70°C).
- Product tightness is guaranteed for normal operating conditions when the product leaves the factory. It is the user's responsibility to maintain the level of tightness particularly when pumping dangerous products.
- All electrical connection must be performed by a qualified electrician must comply with national and local codes.

Be sure to fill the pump with oil (see page 27).

Operating temperature

- At start-up, before switching on the motor, check that the oil bath temperature is greater than 53°F (12°C).

- The ambient operating temperature for the pump must be between 53°F (12°C) and 95°F (35°C).

- Under these conditions, the stabilized pump temperature (at the front of the oil case) will be between 140°F and 158°F (60 and 70°C) (depending on operating conditions).

Before starting-up the pump



Check that the exhaust orifice is not blocked.

In certain cases, when the pump is started up in cold ambient conditions, or with slightly contaminated oil, the current after start-up may remain high until the oil in the pump is heated up. These conditions are sufficient for the internal thermal protection to be activated, making start-up impossible (see pages 25).

Start-up

- Check the oil level (*See page 21*).
- Start-up the pump.
- Allow the pump to run for one hour with the inlet blocked at ultimate vacuum: During this operation, make sure that the oil circuit is operating. Remove one of the oil fill plugs to listen to the pump.

At start-up, the oil enters the lubrication circuit of the vacuum pump. As a result, noises will be heard (first irregularly, then regularly) which will reduce as the oil heats up. These noises will no longer be heard when the fill plug has been replaced.

Under normal temperature conditions, the oil circuit should start less than 1 minute after start-up (this time may vary with the type of oil and its degree of contamination).

- Using the gas ballast:
 - to decontaminate the pump's oil;
 - to accelerate heating. It is normal for the oil level to change (as can be seen through the oil sight glass) when the pump is hot, due to expansion of the oil, starting of the oil circuit and the operating conditions of the pump (inlet pressure). If necessary, stop the pump and adjust the oil level between the "max" and "min" levels on the sight glass.

In the event of a malfunction, refer to the "Troubleshooting and corrective actions" table (*page 29*).

Electrical connections



The pumps must be connected to an electrical installation in compliance with the decree 88-1056 dated 14 November 1988, as well as any local electrical codes that apply.

- Our products are designed to meet current EEC regulations.

Any modification on the part of the user is liable to cause non-compliance with regulations or even affect the EMC (Electromagnetic compatibility) performance and safety of the product. VARIAN cannot be held responsible for consequences resulting from such an intervention.

- Before any maintenance is performed on a product by a maintenance operator who has not been trained on safety regulations (EMC, electrical safety, chemical pollution, etc.), isolate the product from its various energy sources (electricity, compressed air, etc.)
- **As a general rule, it is recommended to protect the motor for 120% of its nominal current (see page 25).**
- Check that the electrical wiring of the motor corresponds to the line voltage, before starting up the pump.
- Ensure that the electrical installation conforms with your local safety requirements. It must include the appropriate fuse and reliable earthing.

Single-phase version

The motor is delivered pre-wired for the specified ordered voltage (*see page 25*). It is equipped with a 2 meters length power cord.

The plug is equipped with a ground pin which must be connected.

The motor rotation direction is set at the factory (*see page 25*).

Specific internal protection

Single-phase motors (protection IP44-TEFC-type) have a thermal circuit switch with automatic starting device (CSA standard): when the internal motor temperature reaches a value over the preset limit value, the motor stops. However, when the motor is cooled, it will start-up again automatically.

External motor protection, electrical protection

Motor characteristics, connection, protection

The information below is given as a recommendation.

The user must comply with the electrical standards or recommendations (IEC, VDE, UL, CSA, etc.) applicable in the country in which the pump is used.

The use of electrical protection for the pump motor makes it possible to protect:

- The motor: in the event of excess voltage or rotor blocking, the resulting excess current may destroy the coil and possibly the start-up system (for a single-phase motor).
- The pump: in the event of a lubrication fault (contaminated oil, presence of particles), increased resistance will draw excessive motor current.

Differential thermal circuit-breakers should be used, in which the mechanism contains an instantaneous disconnection controlled by a bi-metal blade.

♦ single-phase motor:

The table below gives the characteristics at start-up (for temperatures $\geq 12^{\circ}\text{C}$) and in permanent operation.

In this table, you will find a standard fuse or motor-associated value.

Summary tables of various types of motors

The characteristics and ratings of fuses and circuit breaker associated with standard VARIAN pump motors, 2 m³/h, single-phase.

Single-phase motor

Motor	Voltage/Frequency	Current at Ultimate Pressure (A)		*Start-up current (A)		Proposed Fuse protection (A)	
		50 Hz	60 Hz	50 Hz	60 Hz	Standard	Type aM**
Elnor (Europe)	220/240V 50Hz	1.5	-	4.0	-	10	2
	115V 60Hz	-	3.0	-	13.0	10	4
	110/115V 50/60Hz	2.5	3.5	10.0	9.0	10	4
	200/230V 50/60Hz	1.5	2.0	5.0	5.0	10	2
Franklin (U.S.)	115V 60Hz	-	3.5	-	22.0	10/16	4
	208V 60Hz	-	1.5	-	11.0	10	4
	230V 50/60Hz	3.0	2.0	9.0	9.0	10	4

* Temperature = 12°C

** aM : Motor-associated type fuse

Mechanical connections

 For a given application, pump performance, vacuum characteristics, temperature and reliability depend on the following:

- assembly conditions, accessory filters.
- the oil used.
- mechanical connections: pipes, etc.
- maintenance frequency and quality.

For the assembly of the vacuum circuit, provide the necessary accessories required for maintenance: valves, purges, etc.

Mounting on a frame

The pump can be mounted on a frame using the 4 attachment holes on the base and the shock mounts supplied.

Ventilation

The pump and the motor are each equipped with a ventilation system. During pump installation, the pump should be placed in ventilated place. Provide a minimum gap of 25 mm around the pump.

The vents on the pump and the motor should be checked regularly to ensure that they are not blocked.

VARIAN pumps are designed for operation at an ambient temperature between 53°F and 95°F (12 and 35°C).

Inlet and exhaust fitting

 Remove the protective caps on the inlet and exhaust orifices; these components prevent foreign bodies from entering the pump during transport and storage. **It is dangerous to leave them on the pump during operation.**

The pump inlet and exhaust orifices can be used to fit various line components made of stainless steel, plastic, etc. (see Varian catalog).

Inlet

Connection: DN 16 ISO-KF.

 Make sure that all components and chamber connected to the pump inlet withstand a negative pressure of 1 bar relative to atmospheric pressure.

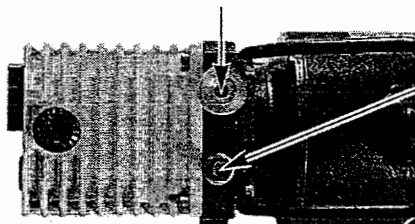

 Also make sure that the maximum excess pressure does not exceed 1 bar relative to atmospheric pressure (for security).

Exhaust

Connection: 10 mm diameter slotter nipple for use with hose (connected to frame by G 1/4 thread).

 It is recommended to connect the pump exhaust to a smoke evacuation duct.

- At the pump exhaust, the evacuation circuit must be such that the resulting excess pressure in the oil case is as low as possible: for correct pump operation the max. exhaust pressure recommended should be 1.125 Torr (1.5 bar / 5 PSI) absolute pressure.

Changing position of inlet fitting

Depending on the type of accessories used and the pumping conditions, this orifice can be fitted vertically on the pump or horizontally as shown on the diagram below.

Note: The pump is supplied in configuration A.

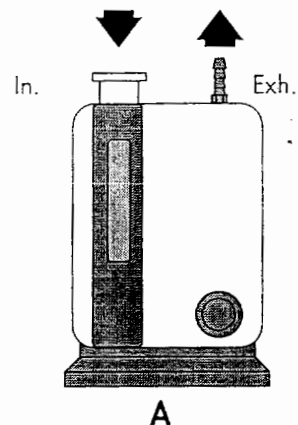

Disassembling the inlet fitting (for maintenance operation)

To unfasten the inlet end fitting, connect the fitting to another DN 16 connecting flange using a centering ring and clamp.

Use it to unscrew the fitting. Remove it from its housing along with the O-ring.

Check that the unused orifice (located on the housing side) is closed with plug (thread G 1/4").

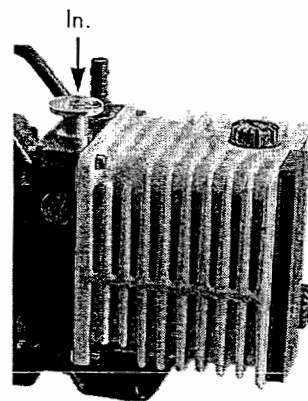

Maintenance

General precautions

For normal operation, the maintenance of VARIAN SD series pumps only require regular oil changes.

 Before any draining or maintenance operation, check the pumping conditions of the installation: potential toxicity, corrosion or radioactivity of pumped gases.

Depending on the case, we recommend:

- to purge the pumping installation with dry nitrogen before maintenance;
- wear gloves, protective goggles and, if necessary, a breathing apparatus;
- ventilate the premises well and disassemble the equipment under a suction hood;
- not to dispose of used oils and residues using the standard system and, if necessary, have them destroyed by a specialized company.

 Certain gases can become corrosives and toxic when trapped in oil. Always wear protective gloves when handling used and dirty pump oil, drain it into a closable container, and do not breathe the fumes of the oil. Always use fully self-contained breathing apparatus.

 Always dispose of used dirty oil, or sub-products properly and in compliance with all local, state and federal environmental laws and regulations.

 After a complete maintenance operation, it is recommended to perform a helium leak tightness test.

Troubleshooting and corrective actions

Incidents	Causes	Corrective actions	
The pump is not running	<ul style="list-style-type: none"> • Incorrect motor power supply. • Temperature too low. • Gumming of seals after prolonged storage. 	Check the power supply. Reheat the pump and its oil. 1 - Disassemble the motor and try to turn the shaft manually. 2 - Disassemble, clean the pump, replace seals, reassemble.	
	<ul style="list-style-type: none"> • Oil contaminated after pumping. 	Drain, flush and refill with clean oil.	
	<ul style="list-style-type: none"> • Motor coupling damaged. 	Replace by disassembling the motor.	
	<ul style="list-style-type: none"> • Pump seized, due to a stopping after pumping in difficult conditions (no draining or flushing). 	Disassemble, clean, hone the scratched metal parts (replace them if necessary) and reassemble.	
The pump does not start	<ul style="list-style-type: none"> • Oil cold. • Insufficient oil in the oil case. • Oil contaminated. 	Warm pump. Fill up to the level. Drain, flush and refill with clean oil.	
	<ul style="list-style-type: none"> • Oil pump inlet partially blocked. 	Drain, and clean the oil pump inlet duct.	
	<ul style="list-style-type: none"> • Air inlet jet or discharge jet obstructed. 	Disassemble and clean.	
	<ul style="list-style-type: none"> • Lubrication holes blocked. 	Disassemble and clean.	
	<ul style="list-style-type: none"> • Oil pump vane damaged. 	Replace them.	
	<ul style="list-style-type: none"> • Incorrect anti-suckback system assembly. 	Repeat the assembly.	
The vacuum pump does not produce a vacuum	Ultimate pressure obtained: a few mbar, Torr		
	<ul style="list-style-type: none"> • Insufficient motor power. 	Check the power supply.	
	<ul style="list-style-type: none"> • Inlet blocked. 	Clean.	
	<ul style="list-style-type: none"> • Insufficient oil in the oil case. 	Add oil.	
	<ul style="list-style-type: none"> • Oil cold, oil pump inlet blocked. 	Warm, disassemble, clean.	
	<ul style="list-style-type: none"> • Oil contaminated. 	Drain, flush and start again with clean oil.	
	<ul style="list-style-type: none"> • Oil pump inlet partially blocked. 	Drain and clean the oil pump inlet duct.	
	<ul style="list-style-type: none"> • One of the LP safety valves is damaged. 	Replace.	
<ul style="list-style-type: none"> • Part forgotten in reassembly. 	Repeat the reassembly.		

Incidents

Causes

Corrective actions

The vacuum pump does not produce a vacuum (continued)

Ultimate pressure obtained: a few 10^{-2} Torr (10^{-2} mbar)

- Gas ballast adjustment button open.
- O-ring pinched.
- One of the seals is damaged.
- One of the HP safety valves is damaged.
- Lubrication holes blocked.
- Incorrect anti-suckback assembly.
- Part forgotten in reassembly.

Accessories

- At the pump exhaust, the installation produces an exhaust pressure of 1,125 Torr (1.5 bar).
- Oil mist eliminator cartridge clogged.

Close.

Replace.

Replace.

Replace.

Disassemble and clean.

Repeat the assembly and setting.

Repeat the reassembly.

Check the installation.

Replace.

Noisy pump

- Oil level too high.
- Oil contaminated (presence of particles).
- Pump not prepared for the oil used.
- Incorrect motor power supply.
- Motor bearings damaged.
- Motor coupling incorrectly set or damaged.
- Incorrect anti-suckback device assembly.
- Air or oil jet clogged.
- Vanes damaged or stuck.

Drain and fill with a new oil.

Drain, flush and refill with clean oil.

Check the pump configuration or the type of oil.

Check the power supply.

Replace the motor after inspection.

Check the setting.

Repeat the assembly.

Disassemble and clean.

Replace.

Pump too hot

- Ambient temperature too high.
- Pump placed in a poorly ventilated place or vents blocked.
- Operation at high pressure $P > 22$ Torr (30 mbar).
- Excess pressure at exhaust.
- Motor in over-voltage or Motor in short-circuit.
- Oil contaminated.
- Pump not prepared for the oil used or oil unsuitable.
- Discharge jet obstructed.

Check the installation.

Check for system leaks.

Check the exhaust line.

Check the voltage, replace the motor.

Drain, flush and refill with clean oil.

Check pump configuration or type of oil.

Disassemble and clean.

Incidents

Causes

Corrective actions

Considerable oil losses.	• Oil level too high.	Drain and fill with new oil.
	• Operation at high pressure.	Use an HP type oil mist eliminator with oil recovery.
	• Gas ballast open: 1 - accidentally, 2 - pumping of condensable vapours.	1 - Close. 2 - Use a condensate collector.
	• Leak at oil case seal or at front seal.	Check the assembly and replace the seals if necessary.
Poor pump tightness when switched off.	• Gas ballast open.	Close.
	• Safety valve damaged.	Replace.
	• Incorrect anti-suckback assembly.	Repeat the assembly.
	• O-ring pinched.	Replace.
	• Seals damaged.	Replace.
	• Oil contaminated.	Drain, flush and refill with clean oil.
Oil in base.	• Oil case and frame cleaned poorly during reassembly.	Remove the base and clean.
	• Oil case seal pinched.	Disassemble the oil case, clean the faces and refit a new seal.
	• Front seal damaged or felt saturated.	Replace.

Maintenance frequency

An incorrect ultimate vacuum or a reduction in pumping speed are signs that the oil has deteriorated.

The periodic inspection of the state of the oil is performed by comparison with a sample of new oil in order to check the level of contamination or deterioration of the lubricant.

The frequency at which oil is renewed is adapted to the type of operation:

- if the oil is cloudy, this indicates that condensables have been absorbed during pumping. The oil can be regenerated using the gas ballast (*see page 14*).
- a thickening of the oil, together with a blackish color and a "burnt" smell indicate that the oil has deteriorated.

Drain the pump and flush it.

Normally, for a pump operating continuously at a pressure lower than 0.75 Torr (1 mbar) with a clean gas (dry air), the oil should be changed every 6 months.

This value is given as a guide only. It may be extended to 1 year if the ultimate vacuum required is sufficient (for primary vacuum pumps).

Similarly, if the pump is stopped frequently for long periods, the oil should be changed at intervals of 6 months to a maximum of 1 year (oil may become sticky).

Note: Every pumping operation is different. This oil must therefore be changed at intervals adapted to each specific application. The use of certain accessories (*see page 20*) can reduce the frequency of these maintenance operations.

Draining

 The draining operation places the contaminated pumping circuit in communication with the outside atmosphere. Take all necessary steps to ensure personal safety.

The pump must be drained when hot and after the oil case has been vented to atmospheric pressure. For this:

- switch off the pump;
- isolate the pump or disconnect from the installation;
- tilt the pump;
- unscrew the draining plug on the side of the oil case and the filling plug on the top of the oil case.

When all the oil has drained, replace the two plugs temporarily and run the pump for about 10 seconds leaving the intake open. Take care with the oil mist which may appear at the exhaust. This operation removes the oil from the functional block;

- drain this oil by removing the draining plug;
- replace the draining plug and fill with fresh oil to the appropriate maximum level of the oil case oil sight glass through the filling orifice (*see page 21*).

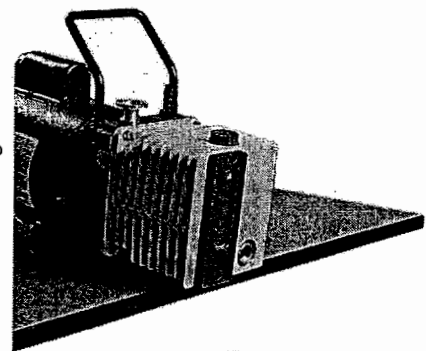

Flushing

The draining operation can be followed by a flushing operation if the oil is particularly dirty. This operation requires a volume of oil equal to the capacity of the pump.

After draining the oil case (*see page 32*), replace the draining plug.
Run the pump at atmospheric pressure, pour the flushing oil **very slowly** through the inlet orifice. Take care with oil mist which may develop at the exhaust.
Stop the pump and drain the flushing oil via the draining plug.
Replace the plug and fill with fresh oil (*see page 21*).

Change of type of oil

SD 40 series pumps are tested in the factory with GP or CS type oil unless specified otherwise in the order. When the pump is delivered, a certain quantity of oil remains in the functional block.

Thus, if you wish to use another type of oil, proceed as follows:

Compatible oils

Mineral oil can be replaced by another type of mineral oil. Simply flush the pump (*see above*) using the new oil and fill the pump (*see page 21*).
Mineral oils are also compatible with mineral-based synthetic oils.

Incompatible oils

This is the case when, for example, a mineral oil is replaced by a synthetic oil. Synthetic oils are considered to be incompatible with each other for practical reasons: they are expensive. A mixture may cause slight cloudiness of the resulting mixture, which could be interpreted mistakenly as a sign of contamination or deterioration.

Disassembling the pump

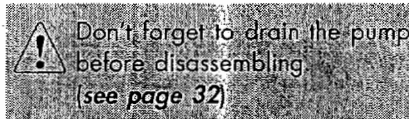

Disassembling the oil case

- 4** Stand pump on end, resting on the motor. Remove the oil case by unscrew 4 screws holding. Remove the o-ring oil casing.

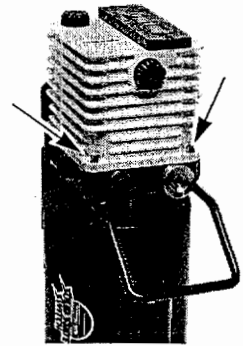

Disassembling the exhaust valve cover

- 4** Remove the valve cover. Remove the complete cover, spacer, valve and spring.

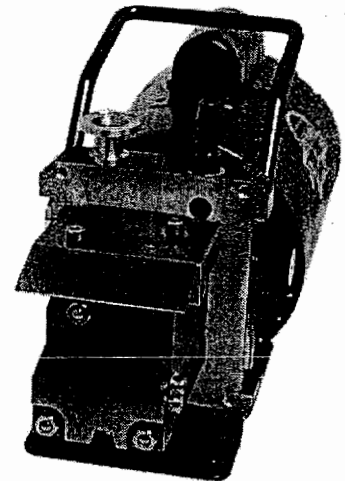

Disassembling the oil pump cover

- 10** Unscrew the 3 nuts holding pump module. Uncouple and remove the cover.

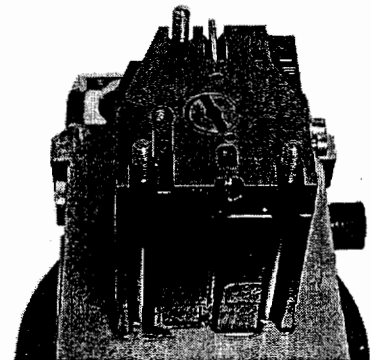

Disassembling the oil pump

- 4** Insert two screwdrivers in the notches, release the flange in the axis, the rotor and the oil pump vane. Unscrew the anti-suckback plug on flange side.

Remove the valve, taking care to not deform the spring. Do not remove air inlet tube: its position has been adjusted in the factory in order to guarantee the optimum compromise between noise level and limit pressure. It must not be modified.

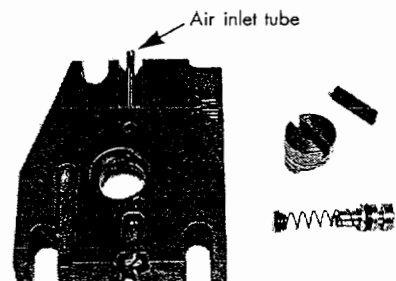

Disassembling the stator

2 With two screwdrivers, uncouple then carefully slide stator, taking care not to damage the rotor, which stays on the front bearing flange. Collect vanes, centering pins, spring and gas ballast ball.

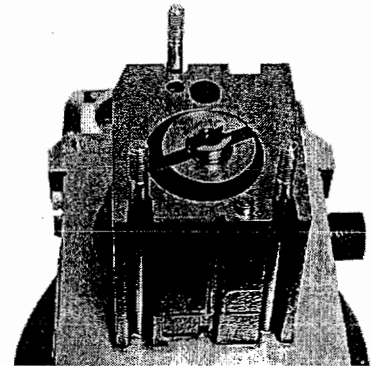

Disassembling the front bearing flange

3 **+** Uncouple then remove the flange, rotor and motor coupling. Loosen screw which fastens sleeve to rotor, remove coupling and rotor. Remove the o-rings stayed in their groove on the frame.



Remove the gas ballast located on the housing side.

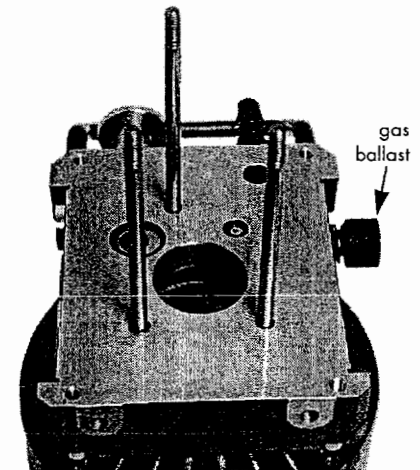

Disassembling the motor

4 Disassemble base of the pump. Loosen the 4 screws holding motor flange to the frame. Remove the handle and the felt.

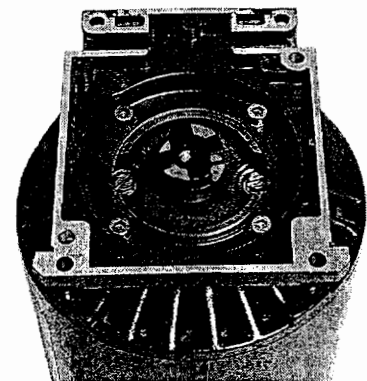

Disassembling the plastic coupling

4 Separate the motor from its flange by unscrewing the 4 screws. Remove the plastic coupling. Unscrew the fixing screw of the motor coupling sleeve and remove it

Cleaning and preparing components

Cleaning metal components

Solvents are required to clean components.

Standard precautions should be taken in compliance with the manufacturer's instructions.

After use in mineral or synthetic oil, clean the metal components with a mineral products based solvent such as **AXAREL**⁽¹⁾, **CARECLEAN**⁽²⁾, **PREMACLEAN**⁽³⁾, **NAPHTEOL**⁽⁴⁾. Proceed as follows:

- Clean when cold or hot (max. 45°C) by dipping or using a cloth
- Vacuum dry in a ventilated oven
- **The component must be cleaned a second time with alcohol.**

After use in (perfluorinate) synthetic oil, clean the metal components in a solvent such as **GALDEN S 90**^{TM(5)} and proceed as follows:

- Clean when cold by dipping or using a cloth
- Dry the components in the air or with compressed air

After use in (non-perfluorinate) synthetic or mineral oil, clean the metal components with a solvent such as alcohol and proceed as follows:

- Clean when cold by dipping or using a cloth
- Dry the components in the air
- Industrial washing solutions can also be used. The cleaning operation should be followed by vacuum drying.

Cleaning the oil level sight glass

SD series pumps

When cleaning this plastic sight glass, avoid contact with alcohol or alcohol-based washing solutions. Clean the component with a solvent, but do not dip it, rinse it immediately.

Component preparation

- All surfaces in contact are coated with oil to be used in the pump.
- Pour a little oil into centering pin holes.
- Observe a **nominal clamping torque of 0.8 mdaN (5.8 ftlbs) for the reassembly of the functional block.**
- Rest the housing on a flat surface in order to re-assemble the pump vertically.

The functional block is reassembled in the reverse order of disassembly.

(1) DUPONT DE NEMOURS registered trademark

(2) CASTROL registered trademark

(3) DOW registered trademark

(4) NIPPON CHEMICAL registered trademark

(5) MONTEFINON registered trademark

Replacement of shaft seals

- Specific tools**
- Specific assembly mandrel.
 - A support plate (or washer).

- Recommended tools**
- A flat screwdriver .

Extracting a shaft seal from its housing

With the flange flat, the seal is extracted using a screwdriver, resting on the plate (or washer) so as not to damage the seal housing.-

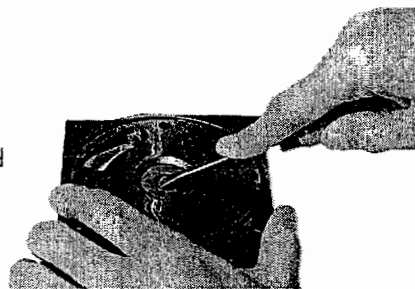

Assembling the shaft seal

The seal housing and the seal lip are lubricated with the lubricant used in the pump. The flange is resting on a flat surface.

According to the direction of assembly specific to each pump, the seal is fitted on the assembly mandrel.

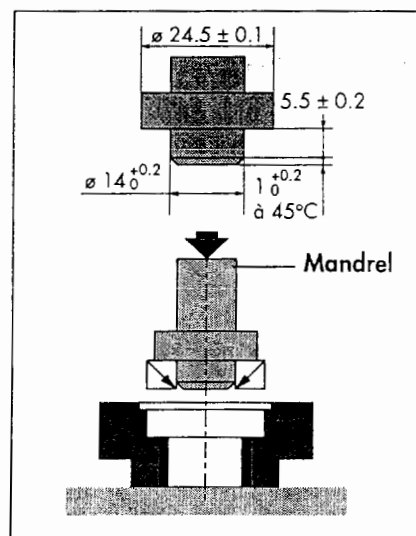

Using a press or a hammer, the seal is inserted in its housing.

Direction of assembly of shaft seals

They are fitted using the assembly mandrel according to the direction of assembly below:

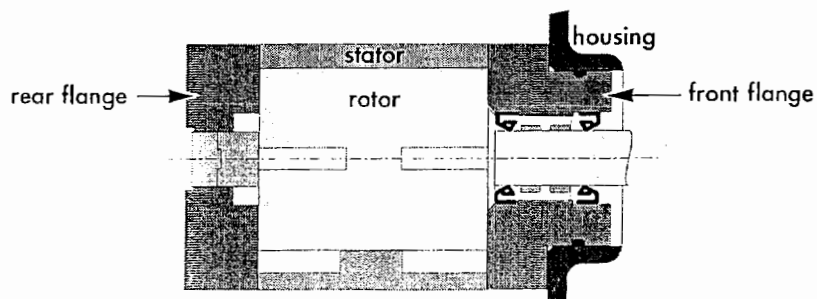

Reassembling the pump

Reassembling the front bearing flange

Install new shaft seals in flange with compliance to instructions of *page 37*.

3 Slide delicately the rotor in place through the lip seals.
Fix the motor coupling on the rotor by tightening the screw.



Place central housing flat on table with motor side down.
Install new o-rings in the housing.
Put in place the front bearing flange equipped with its rotor.

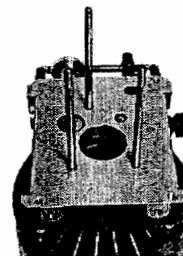

Reassembling the stator

Position both centering pins on front flange as well as gas ballast ball and spring.
Install the LP vanes in the rotor, taking care to place their rounded edges outside.
Carefully slide the stator in place then insert the HP vanes, rounded edges outside.

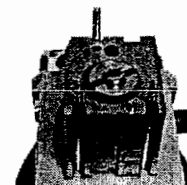

Reassembling the oil pump

Make sure jet and air inlet tube located on rear plate are not blocked, by sending a blast of compressed air through them.
Mount rear plate on oil pump stator which has to be coupled on pumping rotor end.
Install oil pump vane.

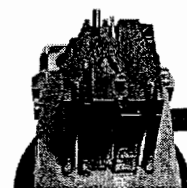

Install anti-suckback device, including o-ring, valve, spring and plug, in rear flange.

10 Mount oil pump cover and tighten 3 M10 screws.
Tightening torque: 0.8 mdaN (5.8 ft lbs).

Reassembling the cap side of valve

④ Pour a little oil into the stator valve hole.

Replace the spring.

Then mount the valve, the spacer and valve cover on stator.

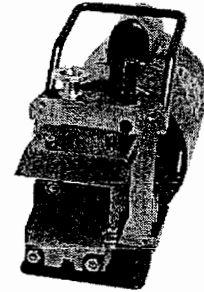

Reassembling the oil case

④ Equip the oil case with new o-ring and mount it on the housing.

Tighten the 4 screws.

Tightening torque: 0.8 mdaN
(5.8 ft lbs).

Reassembling the motor

③ ④ Mount the motor flange on motor taking care to its direction (motor cooling holes downwards).

Place motor coupling on stop on motor shaft and place a new plastic coupling.

Position handle in seat on the flange.

Place the pump on motor flange.

Position the two motor couplings face to face to allow a good coupling.

Finish the mounting by tightening the 4 screws with a torque 0.8 mdaN (5.8 ft lbs).

④ Mount base and secure with screws.

Proceed to the pump oil filling (see page 21) before starting up the pump (see page 22)

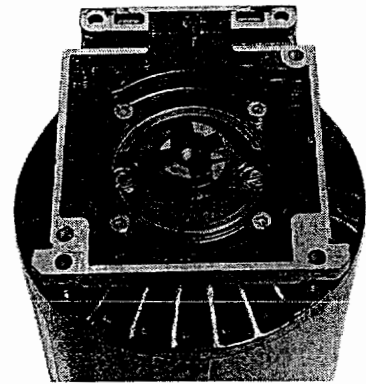

Tools and consumable products

Special precautions

- Read the warning at the beginning of the maintenance chapter.
- Before disassembling the pump, drain it (*see page 32*).
- All the seals and faulty parts should be replaced, provide for a seal kit or a maintenance kit.

Spare parts

Minor kit This contains all the seals on the pump which must be replaced at each complete disassembly.







Pump models	Part No.
SD 40	P1916301

Keep this kit in a dry place, away from heat and light (sunlight and ultraviolet light), in order to prevent any hardening of the elastamers (see AFNOR standards: "storage conditions for vulcanized elastomer based products" - FD T.46 022).

Major kit In addition to the seal kit, this kit contains a set of spare parts to perform maintenance operations on the pump for a two year period, under normal operating conditions.

Pump models	Part No.
SD 40	P1994301

Recommended tools

- One 5.5 x 100 flat screwdriver 
- Thin spanner: 8 and 10 mm on face  
- Allen wrenches: 2.5 - 3 - 4 mm   

Varian Vacuum Products International Sales & Service Offices

America

Varian Vacuum Products
121 Hartwell Avenue
Lexington, MA 02173
USA
Tel: (617) 861-7200
Fax: (617) 860-5437
Toll Free # 1-(800) 882-7426

England

Varian Ltd.
28 Manor Road
Walton-On-Thames
Surrey KT 12 20F
England
Tel: (44) 1932 89 8000
Fax: (44) 1932 22 8769

India

Varian International AG
No. 7 Community Center, 1st Floor
Basant Lok, Vasant Vihar
110057 New Delhi
India
Tel: (91) 11 688 6716
Fax: (91) 11 687 3664

Australia

Varian Australia Pty., Ltd.
6/81 Frenchs Forest Road
Frenchs Forest, NSW 2086
Australia
Tel: (61) 2 451 9133
Fax: (61) 2 452 2600

France

Varian S.A.
7 avenue des Tropiques
ZA de Courtaboeuf - BP 12
Les Ulis cedex (Orsay) 91941
France
Tel: (33) 1 69 86 38 38
Fax: (33) 1 69 28 23 08

Italy

Varian S.p.A.
via Flli Varian 54
10040 Leini, (Torino)
Italy
Tel: (39) 11 997 9111
Fax: (39) 11 997 9360

Brazil

Varian Industria e Comercio Ltda.
Avenida Dr. Cardoso de Melo 1644
Vila Olimpia
Sao Paulo 04548 005
Brazil
Tel: (55) 11 820 0444
Fax: (55) 11 820 9350

Germany

Varian GmbH
Kuchnstrasse 71D
D-22045 Hamburg
Germany
Tel: (49) 40 669 6033
Fax: (49) 40 668 2282

Japan

Varian Japan Limited
Sumitomo Shibaura Building
4-16-36 Shibaura
Minato-ku, Tokyo 108
Japan
Tel: (81) 3 5232 1211
Fax: (81) 3 5232 1263

Canada

Varian Canada
6705 Millcreek Drive, Unit 5
Mississauga, Ontario L5N 5R9
Canada
Tel: (905) 819 8188
Fax: (905) 819 8348

Varian GmbH
Postfach 11 14 35
64229 Darmstadt
Germany
Tel: (49) 06151 703 205
Fax: (49) 06151 703 279

Korea

Varian Korea Ltd.
433-1 Mogok-Dong
Songtan-Shi, Kyungki-Do 459-040
Korea
Tel: (82) 333 665 5171
Fax: (82) 333 665 0118

China

Varian China Ltd.
903-904 Beijing Yanshan Hotel
138A Haidian Road
Beijing 100086
China
Tel: (86) 1 256 4360
Fax: (86) 1 257 6321

Hong Kong

Varian Pacific, Inc.
Rm 1018-20, Tower A
New Mandarin Plaza
14 Sciencia Museum Rd.,
Tsimshatsui East, Kowloon
Hong Kong
Tel: (852) 2724 2836
Fax: (852) 2369 4280

Varian Technologies Korea, Ltd.
Shinsa 2nd Bld. 2F
966-5 Daechi Dong
Kangnam Gu, Seoul
Korea 135-280
Tel: (82) 02 3452 2452
Fax: (82) 02 3452 2451

Mexico

Varian S.A.
Liverpool 96
Colonia Juarez 06600
Mexico, D.F.
Tel: (52) 5 533 5985
Fax: (52) 5 514 5383

Representatives in most countries

Internet Users:
Customer service@vpl.varian.com

Also see Varian's Home Page at:



vacuum products

VPD Service Operation



Returned Material Report

This report must accompany all product returned for repair, replacement, or warranty evaluation. Full information regarding reasons for return of the product will expedite repair or adjustment. Please fill in all blanks below and furnish any other information which will help identify the nature and cause of failure.

Reason for Return (check appropriate box)

- Paid Repair
- Advance Exchange
- Shipping Error
- Credit
- Warranty evaluation
- Loaner Return
- Shipping Damage

Product information (use separate forms if more than one model no.)

Varian Model No. _____ Serial No. _____ Quantity _____
 Part Description _____

Purchase information (if product is being returned for warranty evaluation, show your original purchase order number and date purchased)

Varian Sales Order No. (if available) _____ Machine # _____
 Original Purchase Order No. _____ Purchase Order Date _____

Company Name _____

Address _____

City _____ **State** _____ **Zip** _____

Telephone _____

Failure Report (describe in detail suspected cause or nature of malfunction)

Returned Products

All products returned to Varian/VPD Service Operation for warranty evaluation must be sent **prepaid** and customer must comply with the **warranty replacement and adjustment** provision set forth in the warranty.

Ship directly to: Varian Vacuum Products
 Vacuum Products Service Center
 121 Hartwell Avenue
 Lexington, MA 02173

All products sold by Varian and returned by customer are subject to Varian Vacuum Products standard terms and conditions of sale including, but not limited to, the warranty and damages and liability provisions set forth in the warranty.