



Linkam Scientific Instruments

**THMS600/720**  
**Temperature Controlled Stage**

**USER GUIDE**

## Contents

Before Setting Up Your Equipment.....	3
Important Notice.....	4
Warranty.....	4
Technical Support.....	4
Equipment Maintenance.....	4
Handling Liquid Nitrogen.....	4
Feedback.....	4
Safety Precautions.....	5
Symbol Reference.....	5
Introduction.....	6
THMS600 Stage Specification.....	6
THMS600 System.....	6
Stage Anatomy.....	7
Stage Assembly.....	7
Lid Assembly.....	7
Mounting Stage to Microscope with Dovetail Substage.....	8
Setting up the Condenser.....	8
Vacuum Tweezers.....	9
Connecting the Instruments.....	10
T95 System Controller Cable Connections.....	10
LNP95 Cooling Pump Connection.....	10
Remove Transit Screws.....	10
Back Panel Cable Connection.....	10
ECP Water Circulator Pump.....	11
Sample preparation.....	12
THMS/CC Crucible Carrier and Quartz Crucible.....	12
THMS/CC Crucible Carrier and Stainless Steel Ring.....	13
Cooling Connections.....	14
Purging Procedure.....	15
Use LinkPad to set the LNP95 to Manual Mode.....	15
Filling the Liquid Nitrogen Dewar.....	15
Purging the Stage Method 1.....	16
Purging the Stage Method 2.....	17
Appendix.....	18
Window Assembly.....	18
Lid Window Assembly.....	18
Bottom Window Assembly.....	18
Spares and Accessories.....	19
Troubleshooting.....	21
Contact Details.....	24

## **Before Setting Up Your Equipment**

Please register your products by going to [www.linkam.co.uk](http://www.linkam.co.uk) and click on the product/software registration button.

You will need to register your equipment with us to:

- Activate your warranty and technical support
- Access the online setup videos
- Permanently unlock the Linksys32 software (if purchased)

If you have purchased Linksys32 software, please install the software first. This process will guide to register all of your products.

See Linksys32 manual for further installation instructions.

A CD with a setup videos is supplied with your system.

## **Important Notice**

Please check that your Linkam equipment has not been damaged during transit. If there is any evidence of external damage **DO NOT SWITCH ON ANY ELECTRICAL ITEMS**.

Contact LINKAM SCIENTIFIC or their appointed distributor immediately. Your warranty may be impaired if Linkam is not informed of any transport damage within 7 working days of delivery.

NO attempt should be made to repair or modify the equipment in any way, as there are **no user replaceable parts**.

No attempt should be made to open the case except by qualified personnel as hazardous voltages are present.

In order to use this equipment successfully, please take time to read this manual all the way through before using it.

## **Warranty**

This equipment has a warranty against defects in material and workmanship for a period of 12 months. Linkam will either repair or replace products that prove to be defective. For warranty service or repair, this product must be returned to Linkam or a designated service facility.

The warranty shall not apply to defects resulting from interfacing, unauthorized modification or misuse, operation outside of the environmental specifications for the product, or improper site preparation or maintenance.

## **Technical Support**

Any technical questions or queries should be addressed to the Technical Support Department at the address shown on the back of this manual.

## **Equipment Maintenance**

Use a small quantity of isopropyl alcohol with a soft cloth and gently wipe the surface. To clean the hot-stage, use isopropyl alcohol (IPA) and cotton swabs. Take great care not to touch the platinum temperature sensor protruding from the side of the heating element. The sensor is very fragile.

## **Handling Liquid Nitrogen**

To cool samples below room temperature a LNP95 liquid nitrogen pump is required. Please refer to your health and safety manual for instructions on how to handle liquid nitrogen safely. The Dewar supplied with the LNP95 has a safety release valve built into the siphon assembly. Always use in a well ventilated room.

## **Feedback**

Your feedback will be greatly appreciated, please go to [www.linkam.co.uk](http://www.linkam.co.uk) to fill in the Feedback form.

## Safety Precautions

- 1) Read this guide before using the equipment. Save these instructions for later use.
- 2) Follow all warnings and instructions which may be placed on the programmer or stage.
- 3) If for any reason the mains fuse needs to be replaced then it must be replaced by one of the same type and rating as shown in the equipment ratings.
- 4) To prevent electric shock, do not remove the cover of the controller or associated electronics.
- 5) Never use the equipment if a power cable has been damaged. Do not allow any heavy objects to rest on the power cables. Never lay the power cables on the floor.
- 6) Do not obstruct any ventilation holes. Do not attempt to insert anything into these openings. Provide adequate ventilation of at least 75mm all around the equipment.
- 7) Do not expose the equipment to water. If for any reason it gets wet then unplug it from the mains and contact Linkam Scientific Technical Support.
- 8) The equipment is not intended to be used outdoors.
- 9) Each product is equipped with a 3-wire grounded (earth) mains plug or a free-end 3 wire mains lead. The plug only fits into a grounded-type outlet. The free-end mains lead should be connected to a correctly grounded 3-wire mains outlet. Do not defeat the purpose of the grounded (earth) type plug.

Free - end mains leads are colour coded as follows :

Colour	Function
Brown	Live
Blue	Neutral
Green/Yellow	Earth (Ground)

- 10) If any problems occur then unplug the equipment from the mains outlet and contact Linkam Scientific Technical Support.
- 11) Do not remove the cover from the equipment unless the mains inlet has been removed. Any servicing should be carried out by qualified service personnel.

### *Symbol References*

#### **Caution:**

This safety symbol is on the back panel of the equipment and warns:-



The user must not make or remove any connections while the unit is powered on. To avoid electric shock do not remove the cover. Refer servicing to qualified service personnel.

#### **Caution:**



This warning symbol indicates that the surface labelled with this symbol may be hot.

## Introduction

Thank you for purchasing the THMS600 Heating and Freezing stage system. Please take the time to read through the manual as it will help you to make the most out of the equipment.

### *THMS600 Stage Specifications*

Maximum temperature:	600°C
Minimum temperature:	-196 °C with LNP95
Maximum heating rate:	150°C/min
Objective Lens WD:	4.5mm
Condenser lens WD:	12.5mm
XY-Manipulators travel:	16mm
Aperture hole:	2mm
Weight:	0.62Kg



THMS 600 System with LNP95

## THMS600 System

The system consists of a THMS600 stage, a T95-LinkPad System Controller and optional LNP95 liquid nitrogen cooling pump.

Linksys32 System control software and digital video capture can be added as an option to control from PC.

The THMS600 stage is mounted onto the microscope by using either specific stage clamps, an adaptor plate or by simply placing on the XY table of the microscope, using double sided adhesive tape.

## Stage Anatomy

### Stage Assembly

1. Lemo connector for stage lead
2. Heating element carrier assembly
3. Stage body
4. Stage body water connector
5. Gas purge valve
6. Y-Sample manipulator
7. Stage door
8. Door locking thumbscrew
9. X-Sample manipulator
10. Liquid nitrogen cooling connector
11. Bypass stage body water cooling connector
12. Sample chamber
13. Earth safety contact for lid

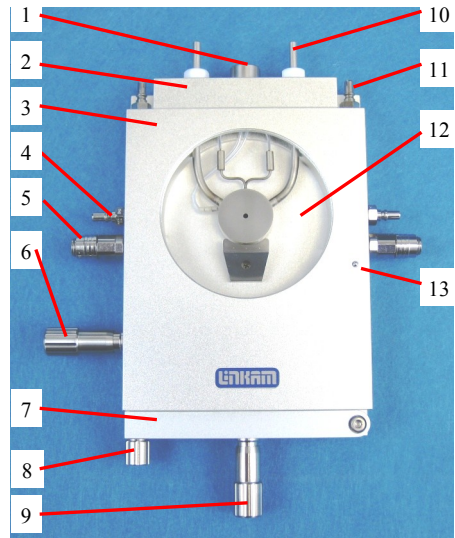

15. Heating element wire
16. Stainless steel cooling tube
17. 22mm diameter pure silver heating block
18. Platinum temperature sensor
19. Sample holder ramp
20. Aperture hole

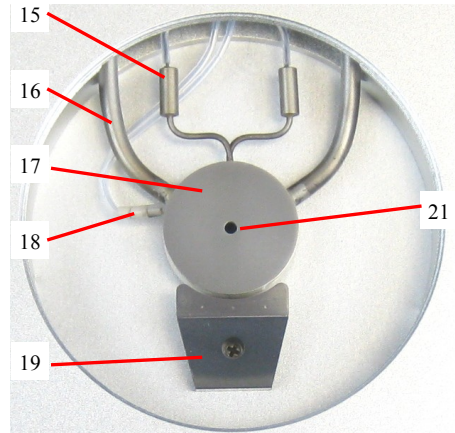

### Lid Assembly

The Stage Lid is removed from the stage by unscrewing anti-clockwise.

21. Stage Lid
22. Lid Insert
23. Viewing Window (22mm glass)
24. Holes for Tube Clip Holder or window removal tool

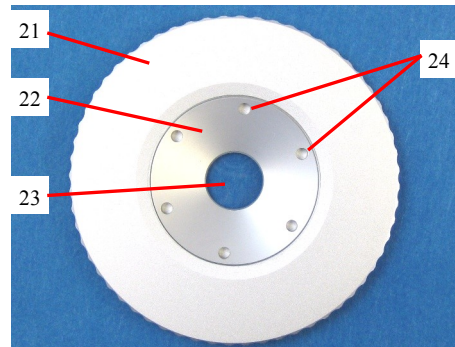

## Mounting Stage to Microscope with Dovetail Substage

The following description is for mounting the stage on to microscopes which have a circular dovetail substage assembly (1).

Attach the curved stage clamps (part no. 9542) to the base of the stage using the supplied hex screws and the outer most holes in the base plate.

Adjust the two positioning screws (2) so that approximately 5mm of thread is exposed on the inside edge of the clamp. This will roughly position the stage in the centre of the dovetail.

Place the stage onto the dovetail, then focus a 10X objective lens on the aperture of the silver block. Using the two positioning screws (2) ensure that the aperture is in the centre of the field of view and lock the stage in place by tightening the Locking Thumbscrew (3).

For other types of microscope substage, refer to the diagram included with the stage adaptor.

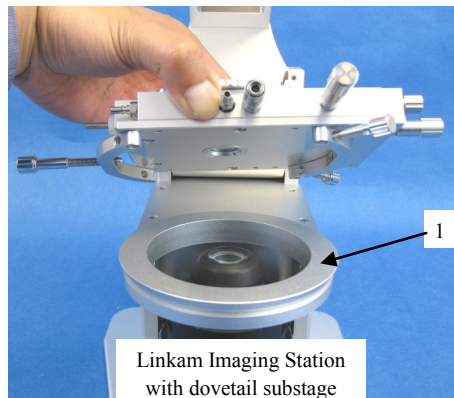
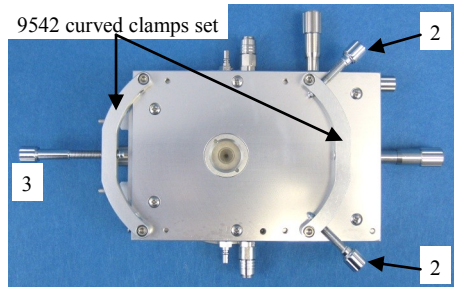

### *Setting up the Condenser*

Place a small sample on a cover slip and place onto the surface of the silver block. Use a 5X or a 10X lens to focus on the sample. Now close down the microscope field diaphragm and adjust the condenser focus so that the edges of the diaphragm are in focus. Now use the condenser positioning screws to centre the condenser in your field of view. Open the diaphragm so that it just fills the field of view.

For more information about Koehler illumination see the extremely informative 'Microscopy Primer' on the Molecular Expressions website.

<http://micro.magnet.fsu.edu/primer/index.html>

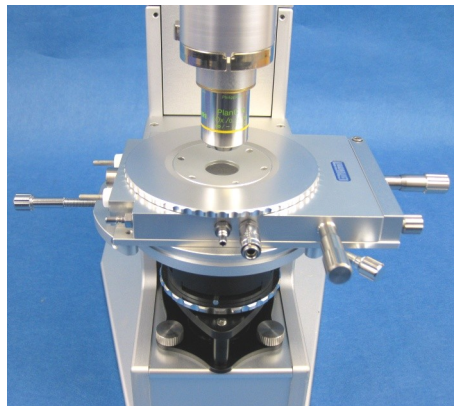



## Vacuum Tweezers

The vacuum tweezers are used to manipulate the glass sample slides onto the silver block to prevent fingerprints on the glass and scratching the surface of the silver block when using standard fine tip metal tweezers.

The System is supplied with a Vacuum Tweezers Kit which consists of a Vacuum Pump (1) and tweezers (2).

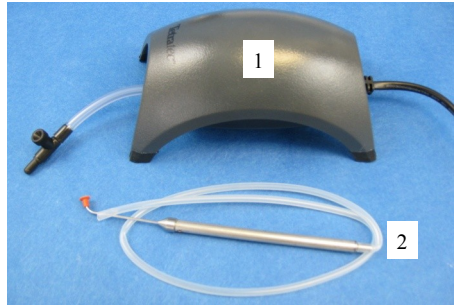

Connect the tubing at the end of the tweezers to the Regulator Valve (3) connection.

Use the dial on the valve to adjust the vacuum for the tweezers.

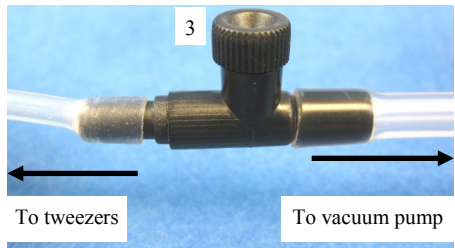

Use a finger to block the hole of the tweezers to pick up a sample cover slip with the suction cup.

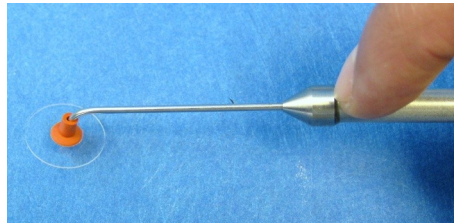

Release the finger to drop the sample cover slip.

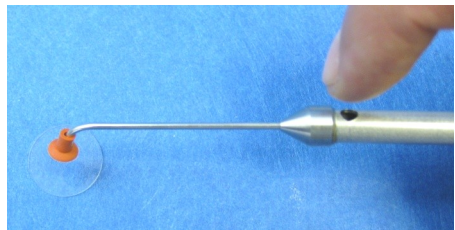

## Connecting The Instruments

### T95 System Controller Cable Connections

For more details on the T95 System Controller please refer to the T95 System Controller manual.

Connect the Stage Cable to the Lemo Connector on the stage and connect the other end to the Stage Connection Socket (1).

If connecting an LNP95 cooling pump you must switch this on **BEFORE** you switch on the T95 controller.

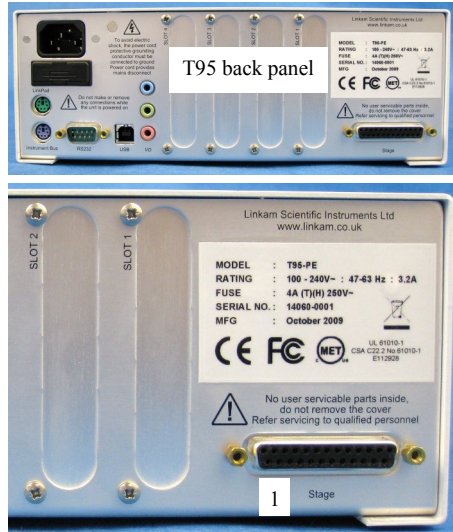

### LNP95 Cooling Pump Connection

If your system is supplied with a LNP95 Liquid Nitrogen Cooling Pump System, setup the LNP95 as described below.

#### Remove Transit Screws

Before using the LNP95 remove the 4 transit screws, marked by small yellow labels (2), from the base of the LNP95. Transit screws shown by arrows in the adjacent image. These screws hold the pumps in place for shipping.

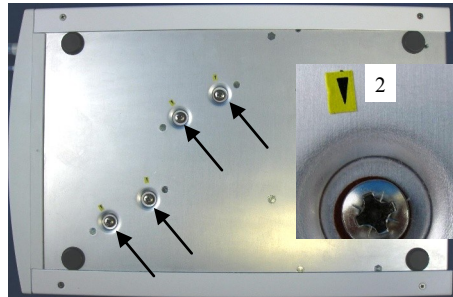

Keep the screws safe by screwing them into the holes on the back panel as shown by the arrows.

The screws must be replaced back into the transit holes on the base, when shipping back to Linkam for service or repair.



#### Back Panel Cable Connection

Connect the Instrument Bus Cable (3) between the LNP95 and T95 as shown.

Note: either of the purple coloured Instrument Bus Sockets on the LNP95 can be used.

**LNP95 MUST BE SWITCHED ON BEFORE T95 SYSTEM CONTROLLER**



### *Setting up ECP Water Circulator Pump*

If you have purchased the ECP with your system, read the following to set up the ECP with the THMS600 stage. Refer to the ECP manual for more details.



When heating the stage above 300°C for a prolonged period of time, the metal casing body of the stage can get quite hot. Connect the tubing as shown in the opposite picture.

**Note:** If you have an LNP95 Liquid Nitrogen Cooling system, the tubing from the Dewar must not be connected to the THMS600 stage when heating above 300°C. The thin black capillary tube will melt inside the heater and damage it.

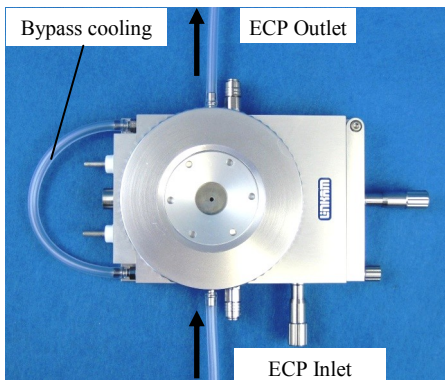

## Sample Preparation

The THMS/CC sample holder (1), is either used to load larger volume liquid samples using the THMSQ quartz crucible or to load samples on disposable 16mm glass cover slips.

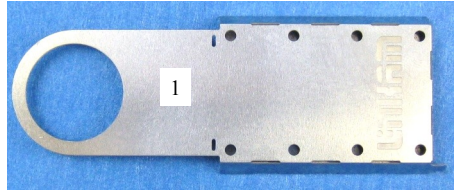

### *THMS/CC Crucible Carrier and Quartz Crucible*

The quartz crucible is useful for loading larger volume liquid samples or when it is preferable to load the sample through the side door without removing the Stage Lid.

Insert the crucible into the THMS/CC sample holder by pushing the crucible into the aperture at the end of the holder.

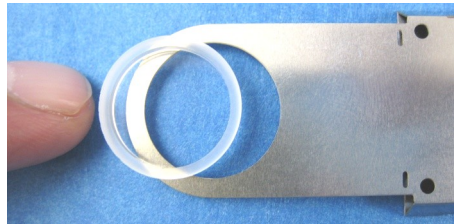

Load the sample into the quartz crucible. Use as little sample as possible to ensure a small thermal load and therefore better temperature sensitivity.

Microscope objectives require a flat surface to give maximum field of view. Place a 13mm cover slip on top of your sample and gently tap the top with the back of the vacuum tweezers to disperse powder samples or ensure good thermal contact of irregularly shaped samples.

Open the side door of the stage by unscrewing the thumbscrew and carefully push the THMS/CC and crucible into the XY slide mechanism.

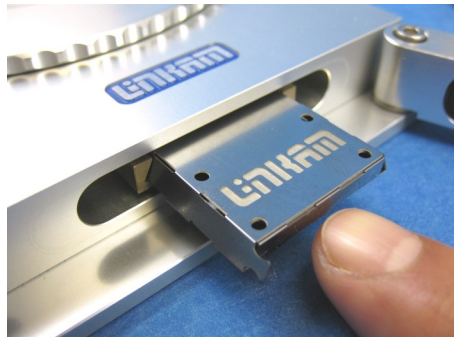

The crucible will be guided to the surface of the silver block by the Sample Holder Ramp. Close the door and tighten the thumbscrew to seal the stage.

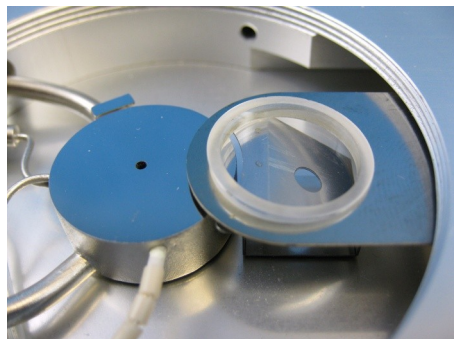

### *THMS/CC Crucible Carrier and Stainless Steel Ring*

This sample loading method is likely to be more routinely used than the quartz crucible as the 16mm sample cover slips can be discarded after each experiment.

Insert the THMS/CC into the stage as described in the previous section .

The THMS/CC should not make contact with the surface of the silver block and should be suspended a few millimetres above it.

Place the Stainless Steel Ring (1) within the THMS/CC.

Tap the edge of the ring lightly to ensure that it has dropped through the aperture of the THMS/CC and sits properly on the surface of the silver block.

It is critical that the ring is able to move freely inside the aperture of the sample holder and sit flat against the surface of the silver block.

Use the vacuum tweezers or a pair of tweezers as shown and place a 16mm glass cover slip (2) into the stainless steel ring. Tap the edges lightly to ensure that it sits flat against the surface of the block. If the cover slip does not sit perfectly flat against the temperature controlled surface the heat flow will be compromised and the sample temperature will be significantly different to the displayed temperature. The Stainless Steel Ring is used to push the 16mm cover slip around the surface of the block when using the XY manipulators.

Using a pipette or tweezers place the sample on the 16mm cover slip. Ensure that the sample is as small as possible and that it is as flat as possible. Heat flow into or out of the sample is affected by the amount of sample area in contact with the temperature controlled cover slip. Place a second 16mm cover slip on top of the sample to create a flat surface for the microscope lens to focus on.

Accurate temperatures can be obtained by keeping the sample as small and flat as possible.

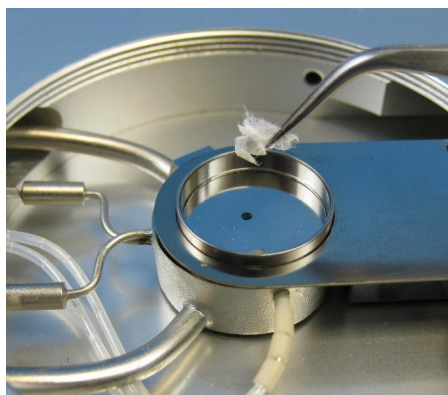
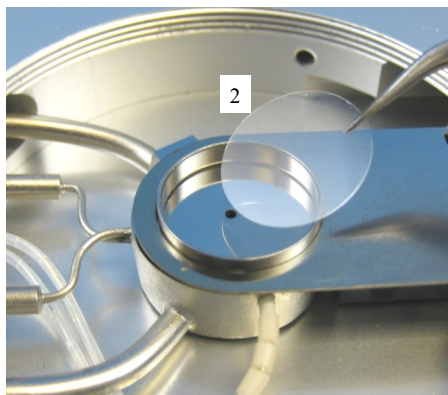
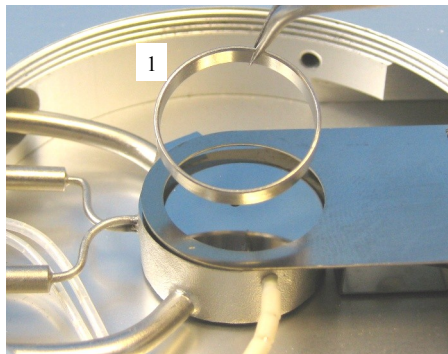

## Cooling Connections

These connections need only be made if the experiments are to be carried out below room temperature.

The Dewar siphon (1) is the thick white foam tubing and is attached to the liquid nitrogen Dewar. The thin black capillary tube inside the white foam tube must be inserted into the liquid nitrogen cooling connectors on the stage.

The white tubing slides on to the outside of the connector. Twist the siphon whilst sliding it on and push until it comes to a stop. It does not need to go all the way to the base of the connector.

The thicker silicon tube from the LNP95 cooling pump ends in a white PTFE connector (2), this is pushed over the end of the other stainless steel connector as seen in the image.

The short tube branching from the side of this white connector is the Gas Purging Tube (3). There is a valve opening Insert connector (4) inserted into the end of this tube. During the purging procedure, insert this connector into the Gas Purge Valve (5) on the side of the stage to open it.

The Gas Purge Valve (5) is opened when the Gas Insert (6) is pushed firmly into the connector, a “click” is heard when the two parts are connected properly. To remove the Gas Insert, push the outer sleeve of Gas Purge Valve toward the stage and the Gas Insert (6) should drop out.

There is a second Gas Purge Valve on the opposite side of the stage to allow the gas to leave the stage. A Gas Insert must also be inserted into this Gas Purge Valve (7) when purging.

The smaller tube from the outlet on the LNP95 should be placed in position on the top of the lid using the Tube Clip Holder (8). This tube blows warm recycled nitrogen gas across the lid window to prevent condensation on the viewing window surface.

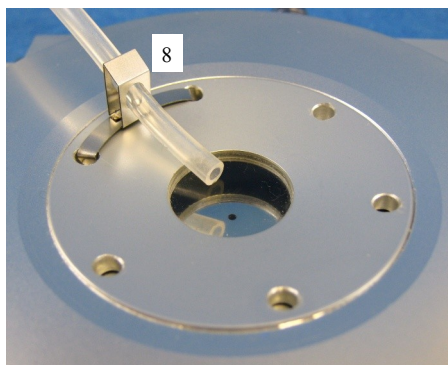
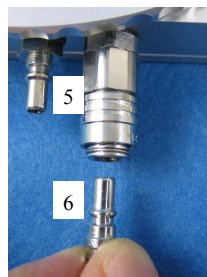
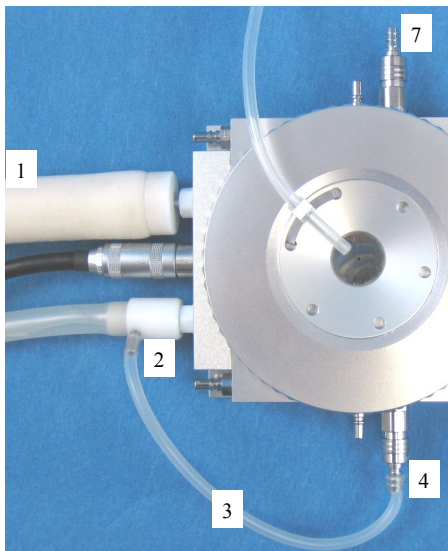

## Purging Procedure

Before starting a cooling experiment, you will need to purge air from the stage chamber with dry nitrogen. This will remove the water in the air which would otherwise condense and freeze on the sample disrupting your image quality.

Before you can start purging, the LNP95 must be set to manual mode.

You can either use the LinkPad touch screen or Linksys32 software.

### *Use LinkPad to set the LNP95 to Manual Mode*

Touch the active area (1) under 'Lnp Speed' to change to the LNP Screen Menu. Touch 'Man' (2) to switch the LNP95 to manual mode.

The word 'auto' is changed to 'speed' to indicate the LNP95 is functioning in manual mode.

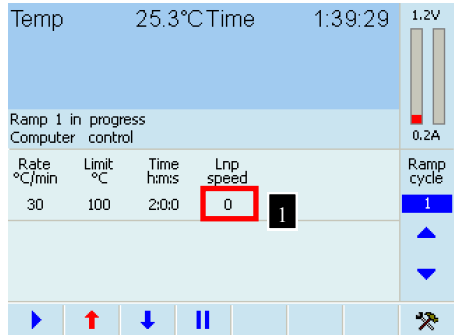

Using the Keypad type in 100 (max pump speed) and touch the 'Enter' button (4) to start the LNP95 at the programmed speed (5).

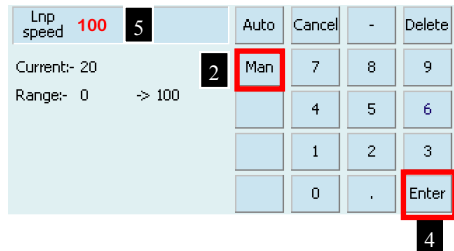

### *Filling the Liquid Nitrogen Dewar*

Please follow your health and safety manual for directions on how to handle liquid nitrogen and ensure that you have the correct safety equipment including gloves and safety goggles.

Fill the Dewar approximately 2/3 full and replace the lid with siphon attached.

**DO NOT FASTEN THE CATCHES**

Wait for the nitrogen to stop bubbling before fastening the catches.

Take care when placing lid on a table to always have the black capillary pointing upwards. It is easily damaged which will impair N<sub>2</sub> flow.

### *Purging the Stage Method 1*

There are two methods for purging the stage. Method 1 uses recycled nitrogen gas produced by the LNP95 from the 2L Dewar.

1. Make sure the stage lid is in place and the stage door is closed.
2. Switch on the temperature programmer and set the limit to 40°C. Press the START button and wait until the temperature limit is reached. Press HOLD to hold the temperature at 40°C.
3. Switch on the LNP95 cooling system and set it to manual mode, (see page 13) and set the speed to maximum of 100.
4. Check that the Gas Inserts are locked into place
5. Using a finger on the left hand, block the hole in the white plastic pump connector found on the perpendicular side to the purging tube. Still working with the left hand, pinch the narrow window tube to block it. This action will divert all of the nitrogen gas to the Purging Tube and through the Stage Chamber.
6. With the nitrogen gas flowing through the Sample Chamber, use a finger on the right hand to block the gas outlet for a few seconds to allow pressure build, then release the gas. Repeat this for a few minutes to purge the stage.
7. Look at the change of reflection in the stage window as the stage is pressurised and released to check that the stage is properly sealed. If there is no change, there may be a leak due to incorrect placing of the silicon o-rings in either the bottom or lid window or the window (top/bottom may be broken).
8. The purging procedure allows mixing of nitrogen gas with the residual air inside the Sample Chamber. By pressurising the chamber with nitrogen gas and releasing it, the air inside the Chamber is being diluted with the nitrogen gas.
9. Remove the two Gas Inserts and unblock the pump connector and window tube.
10. Change the LNP95 to **AUTOMATIC** mode so that the T95 automatically controls pump speed during your cooling experiment
11. Go to [www.linkam.co.uk](http://www.linkam.co.uk) and register your equipment to see videos of how to purge and more.

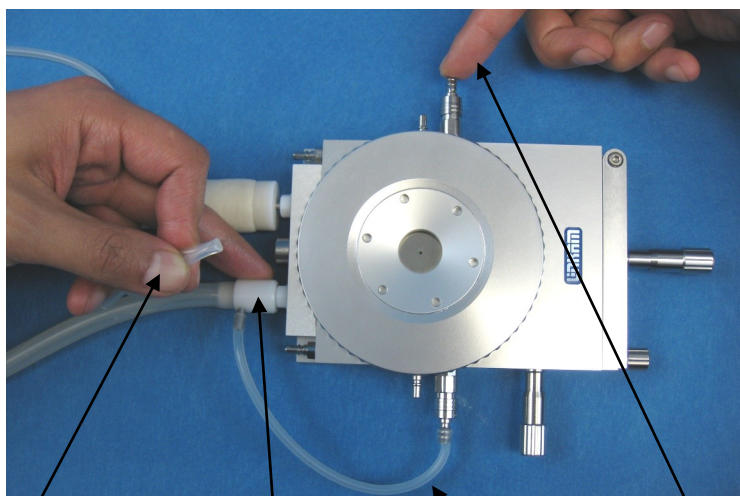

Pinch window tube  
with left hand

Block hole in  
Connector with finger  
pump connector

Purging  
tube

Block and release outlet  
valve with finger



### *Purging the Stage Method 2*

This method uses an inert gas from a gas cylinder to purge the stage at temperatures above ambient when the LNP95 is not required.

1. Make sure the Stage Lid is in place and the Stage Door is closed.
2. From a gas cylinder connect the Gas Insert with a tubing 3mm inner diameter and 6mm outer diameter to the Gas Purge Valve (1).
3. Connect a Gas Insert to the opposite side Gas Purge Valve (2).
4. Use the gas regulator to set a gas flow rate of 1.5L/min.
5. With the gas flowing through the Sample Chamber, block the gas outlet for a few seconds and releasing the gas outlet valve with a finger. Repeat this for a few minutes to purge the stage.

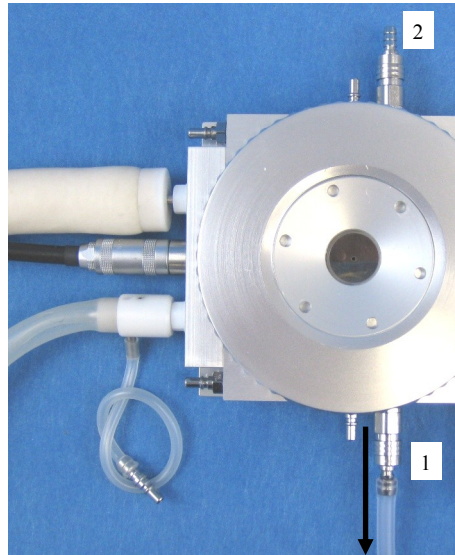

To gas cylinder

Reduce the gas flow rate to 20cc/min to continuously purge the stage or remove the two Gas Inserts to keep the chamber under closed inert atmosphere.

Note: Helium gas is not recommended for continuous purging. This gas has a very high thermal conductivity and will cool the silver heating block too much during an experiment and may cause the temperature to fluctuate.

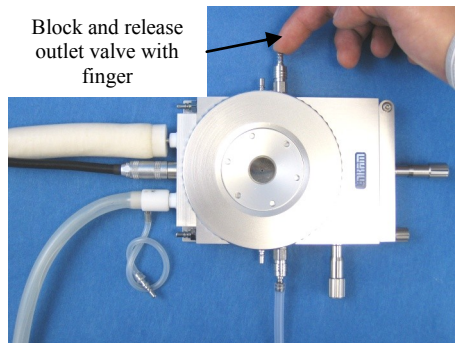

## Appendix

### Window Assembly

#### *Lid Window Assembly*

To replace the windows in the Stage Lid (1) use the Window Tool (2) and align the two wide spacing pins to the Tube Clip Holder holes and unscrew the Lid Insert (3).

The Stage Lid and Lid Insert should be turned upside down as shown in the diagram opposite and reassembled in the order indicated.

The Lid Insert should be screwed down until the cover slips are held firmly, then turn the assembly over and screw down the Lid Insert until it is felt to come to a stop.

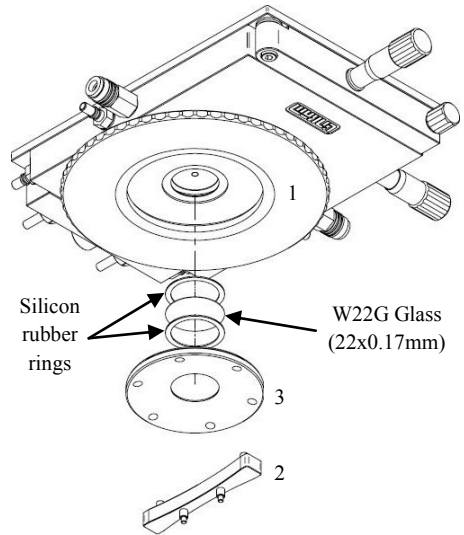

#### *Bottom Window Assembly*

Use two narrow spacing pins of Window Tool (2) to align it to the two holes of Window Locking Ring (4) and unscrew.

Reassemble the bottom window as shown in the opposite diagram

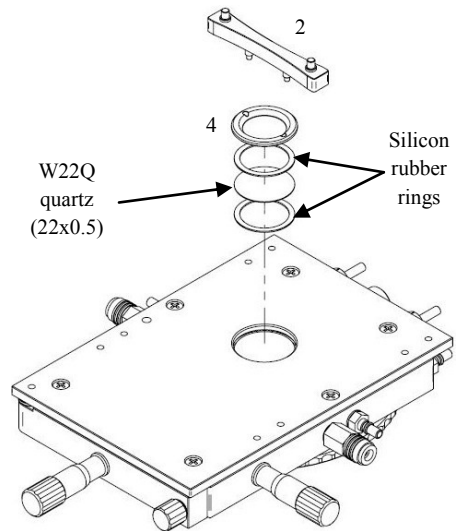

## Spares and Accessories

These spares are organised into convenient kits. Purchase a spares kit to avoid downtime with your stage and eliminate future shipping costs.

The THMS600 heating element is extremely durable if used carefully. However, it is made from pure silver which is a soft metal. It can be easily scratched, which will compromise the heat flow to the sample and reduce accuracy. The platinum temperature sensor is brittle and can be broken if cleaning is not carefully performed. We recommend a spare heating element to avoid downtime with your stage while element is being repaired.

Part No.	Part Name	Part Description
7512	THMS Full Kit	THMS Full Replacement Spares Kit
	WGI	Gas Valve Insert <b>x2</b>
	WVC	Gas Valve Connector <b>x2</b>
	SRR	Silicon Rings for Lid and Base (Set of 4)
	LSR	Large Stainless Steel Sample Ring
	TCH	Tube Clip Holder (for Nitrogen de-fogging stage lid tube)
	THMS/CC	THMS Crucible Carrier
	G16	16mm Sample Carrier (THMS Style)
	THMS/Q	15mm inner diameter Quartz Crucible for THMS/CC <b>x2</b>
	W16Q	Quartz Sample Window 16mm diameter 0.3mm thick <b>x4</b>
	ACCE	Box of Glass for Windows / Sample: 22x0.17mm (x50); 16x0.17mm (x50); 22x0.3mm (x10) x2
	WT	Window Tool (for unlocking lid insert and base locking ring)
	W22Q	22mm diameter Quartz base Window (0.5mm thick) <b>x2</b>

Part No.	Part Name	Part Description
7522	THMS Spare Windows Kit	Spare Windows for Lid, Base and Samples
	THMS/Q	15mm inner diameter Quartz Crucible for THMS/CC <b>x2</b>
	W16Q	Quartz Sample Window 16mm diameter 0.3mm thick <b>x4</b>
	ACCE	Box of Glass for Windows / Sample: 22x0.17mm (x50); 16x0.17mm (x50); 22x0.3mm (x10) x2; 13x0.17mm (x10) x2
	SRR	Silicon Rings for Lid and Base (Set of 4)

Part No.	Part Name	Part Description
7523	WS Kit with SCO	Sapphire Precision Temperature Kit with SCO (not for use with polarised light)
	W7S	7mm diameter Sapphire Sample Window (0.3mm thick) <b>x20</b>
	G7	Sample Carrier for 7mm diameter Standard Straight Edge Window
	SCO	22mm diameter Silver Cover Lid to fit on block for accurate temperature

Part No.	Part Name	Part Description
9585	THMSB	Spare Silver Heating Element incl. Platinum Temperature Sensor

Part No.	Part Name	Part Description
0998	ECP	Water Circulator Pump (stage body and window cooling)(220-240V)
0997	ECP	Water Circulator Pump (stage body and window cooling)(110-130V)

## Troubleshooting

### *Cooling fault diagnosis*

Ensure that all connections to the stage and Dewar are as described in the specific manual and that the stage lid and top windows are properly sealed.

1. *The cooling rate is less than programmed.*

There can be several causes of this problem, the most likely being that one of the connectors has become blocked or damaged. Check that each tube is fitted tightly to the connector and that none of the tubing is twisted or has come loose. The larger diameter tube leading from the LNP95 consists of a tube within a tube, check that the internal tube is connected, it may have come loose. Any constrictions of either the tubing or the connector will have a drastic effect on the cooling ability of the LNP95. If the connectors and tubing are OK, check that the capillary tubing to the Dewar flask is not bent or damaged and that the filter is intact and unblocked. If any damage has occurred to any of these items then it will be necessary to replace them. If no damage is found, check that the silver block is not constricted. This can be checked, simply by blowing through one of the steel cooling tubes using a compressed air line.

2. *Stage will not cool down to -196°C.*

Check that the stage lid is not touching the silver block when screwed down. Check that the silver block has not been pushed down so that it touches the base of the stage. Check the sample holder ramp is not touching the silver block. Any of these faults will cause a substantial loss of cooling ability.

3. *Condensation and ice forming on the upper side of window*

Realign the window gas tube clip to the required position in the stage lid.

4. *Condensation on the sample and/or the underside of lid window*

This is due to the stage not being sealed properly and therefore allowing moisture in during purging or cooling. Check that the lid and bottom window are sealed correctly and that the silicon seals are in position.

**Please visit [www.Linkam.co.uk](http://www.Linkam.co.uk) for more FAQ for the stage and instruments.**

This page is intentionally Blank

This page is intentionally Blank

**Linkam Scientific Instruments Ltd**

Tel: +44(0)1737 363 476

Fax: +44(0)1737 363 480

Email: [support@linkam.co.uk](mailto:support@linkam.co.uk)

Unit 8 Epsom Downs Metro Centre  
Waterfield, Tadworth, Surrey, KT20 5LR, UK  
[www.linkam.co.uk](http://www.linkam.co.uk)

Version: 1.05.1109