



## AN ABSTRACT OF THE THESIS OF

Daniel Paul Speer for the degree of Baccalaureate of Science in Physics presented on May 31, 2016. Title:  
Room Temperature Seebeck Measurements of Silicon Wafers and Thin Film Tetrahedrite Derivatives  
 $\text{Cu}_{10-x}\text{Ag}_x\text{Zn}_2\text{Sb}_4\text{S}_{13}$  on Silicon Substrates

Abstract approved: \_\_\_\_\_  
Janet Tate

The Seebeck coefficients of two thin-film tetrahedrite derivatives  $\text{Cu}_{10-x}\text{Ag}_x\text{Zn}_2\text{Sb}_4\text{S}_{13}$  were measured at room temperature on silicon wafers. For  $x$  values one and three the Seebeck coefficient of 10.2 and 68.0  $\mu\text{V K}^{-1}$  were found respectively. Combined with conductivity measurements, the thermoelectric power factors were found to be in the range of  $10^{-5}$  to  $10^{-7}$   $\text{Wm}^{-1}\text{K}^{-2}$ . The Seebeck coefficients of alumel, chromel, thin film indium-tin-oxide, as well as n- and p-type silicon wafers were also measured at room temperature as a thermoelectric standard to test the validity of the system.

©Copyright by Daniel Paul Speer

May 31, 2016

All Rights Reserved

Room Temperature Seebeck Measurements of Silicon Wafers and Thin  
Film Tetrahedrite Derivatives  $\text{Cu}_{10-x}\text{Ag}_x\text{Zn}_2\text{Sb}_4\text{S}_{13}$  on Silicon Substrates

By

Daniel Paul Speer

A PROJECT

Submitted to Oregon State University

In partial fulfillment of the requirements for the degree of

Baccalaureate of Science in Physics

Presented May 31, 2016

Commencement June 2016

Baccalaureate of Science in Physics and Mathematics project of Daniel Paul Speer presented on My 31, 2016.

APPROVED:

---

Mentor, representing Physics

---

Committee Member, representing Physics

---

Committee Member, representing Physics

---

Chair, Department of Physics

I understand that my project will become part of the permanent collection of Oregon State University. My signature below authorizes release of my project to any reader upon request.

---

Daniel Paul Speer, Author

## ACKNOWLEDGEMENTS

Most importantly I would like to thank Dr. Janet Tate for not only giving me the opportunity to work in her lab but having the patience and dedication not to give up on me. I would like to thank Chris Reidy for his assistance throughout the lab. He was my constant guide through many technical problems as well as an enthusiastic source of knowledge. Thanks to Mark Warner and Larry Nelson for fixing the many mechanical problems that I encountered throughout my project.

Thanks to Dara Easley, though we never had the pleasure of meeting. She is responsible for the Seebeck apparatus and programming behind the data collection. Thank you to Dr. John Wager, Dr. Doug Keszler, Greg Angelos and Jaesoek Heo for providing the tetrahedrite samples used in my research. Thanks to Rodney Snyder for providing Hall measurements as well as constant moral support as we fought our way through this project together.

Last I would like to thank the Center for Sustainable Materials Chemistry for funding this project.

# TABLE OF CONTENTS

<b>1. INTRODUCTION .....</b>	<b>1</b>
1.1 Summary and goals.....	1
1.2 Seebeck coefficient .....	1
1.3 Power factor and Figure of Merit.....	2
<b>2. METHOD.....</b>	<b>4</b>
2.1 Experimental apparatus.....	4
2.2 Cleaning and assembling the Seebeck device.....	5
2.3 Installing samples.....	5
2.4 Checking the samples' electrical contact .....	6
<b>3. MATERIALS .....</b>	<b>7</b>
3.1 Alumel and Chromel.....	7
3.2 ITO thin film (In <sub>2</sub> O <sub>3</sub> :Sn).....	7
3.3 N-type and P-type Silicon.....	7
3.4 Doped goldfieldite (Cu <sub>10-x</sub> Ag <sub>x</sub> Zn <sub>2</sub> Sb <sub>4</sub> S <sub>13</sub> ).....	8
<b>4. EXPERIMENTAL RESULTS .....</b>	<b>9</b>
4.1 Calibration with alumel and chromel.....	9
4.2 Calibration with ITO thin film .....	10
4.3 N-type and P-type Silicon.....	10
4.4 Seebeck coefficient of doped goldfieldite (Cu <sub>10-x</sub> Ag <sub>x</sub> Zn <sub>2</sub> Sb <sub>4</sub> S <sub>13</sub> ).....	11
<b>5. DISCUSSION.....</b>	<b>13</b>
<b>Bibliography .....</b>	<b>14</b>

## LIST OF FIGURES

Figure 1.1: The Seebeck effect is the current generated by applying a heat gradient across two dissimilar metals. ....	1
Figure 2.1: Block diagram of experimental setup.....	<b>Error! Bookmark not defined.</b>
Figure 3.1: Unit cell for the crystalline structure of $\text{Cu}_{12}\text{Sb}_4\text{S}_{13}$ (Johnson and Burnham).....	8
Figure 4.1: TV curves for Alumel and Chromel indicating Seebeck coefficients of $-17.4$ and $20.3\mu\text{V/K}$ respectively. ....	9
Figure 4.2: TV curve of ITO indicating a Seebeck coefficient of $-9.4\mu\text{V/K}$ . ....	10
Figure 4.3: TV curve of n and p-type silicon with Seebeck coefficients of $-816$ and $653\mu\text{V/K}$ respectively.....	<b>Error! Bookmark not defined.</b>
Figure 4.4: TV curves of doped goldfieldite samples with Seebeck coefficients of $71.6$ and $13.0\mu\text{V/K}$ .....	11
Table 4.1: Results for Seebeck measurements of all materials tested. ....	12
Table 5.1: Thermal transport properties of doped goldfieldite. ....	13



# 1. INTRODUCTION

## 1.1 Summary and goals

This project focuses on measuring the Seebeck coefficient of two different forms of doped goldfieldite applied as a thin film on silicon wafers. Doped goldfieldite is a ceramic material produced by the OSU Chemistry department. Doped goldfieldite is a variant of the mineral family tetrahedrite and has the composition of  $\text{Cu}_{10-x}\text{Ag}_x\text{Zn}_2\text{Sb}_4\text{S}_{13}$  where  $x$  is the number of silver atoms replacing copper atoms. Two forms were tested for  $x=1$  and  $x=3$ . The tetrahedrite sample was deposited on a silicon wafer through e-beam deposition during which the lattice is doped by a silver source. The validity of the Seebeck apparatus was tested measuring the known Seebeck coefficients of wire samples of alumel and chromel as well as wafers of n-type and p-type silicon. An indium-tin-oxide (ITO) thin film was also tested to ensure the system's ability to measure samples in thin film form. The goal of this project was to establish the potential of doped goldfieldite as a thermoelectric engine.

## 1.2 Seebeck coefficient

The Seebeck coefficient  $S$  is an important property of material in thermoelectric physics. The Seebeck effect was first discovered in the 1820's by Thomas J. Seebeck (Seebeck). When a heat gradient is applied across the connections of two dissimilar metals, a current is induced as seen in Figure 1.1. The direction and magnitude of current is determined by the material types

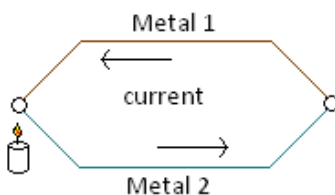

Figure 1.1: The Seebeck effect is the current generated by applying a heat gradient across two dissimilar metals.

and temperature gradient applied across the connection.

This junction of two metals is called a thermocouple and is essential in determining Seebeck coefficients. Because two materials are used to make a thermocouple, only the relative Seebeck coefficient can be measured directly. The relative Seebeck ( $S_{rel}$ ) coefficient is found by measuring the difference in voltage and temperature between the blocks and calculating the ratio between them.

$$S_{rel} = \frac{\Delta V}{\Delta T} \quad (1)$$

The difference in the voltage is  $V_{cold} - V_{hot}$  and the difference in temperature is  $T_{hot} - T_{cold}$  (Kasap, 2001). The differences in voltage and temperature are defined in this manner so that the sign of the Seebeck coefficient sign denotes the carrier type for the material. Materials with a positive Seebeck coefficient are called p-type where the holes move from the hot to the cold side. Negative Seebeck coefficients are referred to as n-type with electrons moving from the hot side to the cold side. The relative Seebeck coefficient is the difference between the sample coefficient and the copper block coefficient.

$$S_{rel} = S_{sample} - S_{copper} \quad (2)$$

The Seebeck coefficient of copper is  $2.7\mu\text{V/K}$  (Bentley). By combining equations (1) and (2) a sample's Seebeck coefficient can be found.

$$S_{sample} = \frac{\Delta V}{\Delta T} + S_{copper} \quad (3)$$

### 1.3 Power factor and Figure of Merit

A material's thermoelectric performance can be predicted by calculating its power factor,

$$\text{Power factor} = \sigma S^2 \quad (4)$$

where  $S$  is the Seebeck coefficient and  $\sigma$  is the electrical conductivity of the material in question. The power factor is used in conjunction with the thermal conductivity, denoted by  $\kappa$ , to find the dimensionless constant called the figure of merit ( $ZT$ ).

$$ZT = \frac{\sigma S^2 T}{\kappa} \quad (5)$$

$T$  is the operating temperature of the material and appears on both sides of the equation to make it dimensionless. The majority of materials have a low figure of merit ( $ZT \ll 1$ ); materials with a high thermoelectric efficiency have a figure of merit  $ZT > 1$ . Materials with a high figure of merit will waste less energy when transforming heat into electricity or vice versa.

Because the Seebeck coefficient is the squared term in the figure of merit, it has the potential to greatly increase  $ZT$ . This has led us to investigate materials with high Seebeck coefficients that have the potential to maximize the figure of merit.

The electrical conductivity of a material can be made to vary over several orders of magnitude by doping the material. The intent is to maximize the Seebeck coefficient ( $S$ ) while maintaining a high electrical conductivity ( $\sigma$ ) and a low thermal conductivity ( $\kappa$ ).

Finding a material with a figure of merit higher than currently known materials would increase the efficiency of components used throughout the modern world. The goal of this research is to find more efficient materials for building better electrical components.

## 2. METHOD

### 2.1 Experimental apparatus

The device used to measure the Seebeck coefficient's software is described in Easley's thesis (Easley, 2003). The Seebeck device consists of two copper blocks that are thermally isolated from each other. A resistive heater is attached to the 'hot' block to elevate its temperature above that of the 'cold' block. Difference in temperature is calculated using Equation 6 by measuring the voltage across an alumel-chromel-alumel differential thermocouple that is imbedded in the center of the copper blocks. This voltage, denoted as  $V_{diff}$ , is measured by a Keithley 195A multimeter. Equation 6 is a variation of Equation 3 when solved for the temperature difference.

$$\Delta T = \frac{V_{diff}}{S_{alumel-Chromel}} \quad (6)$$

The thermocouple is electrically isolated from the copper blocks using teflon tape.

The voltage across the sample is measured with a Tektronix DM 5120 multimeter that is connected to the copper blocks with copper wire of the same quality. This differential copper-sample-copper thermocouple yields the Seebeck voltage of the sample using Equation 3. The entire system was contained in a grounded Faraday cage to reduce noise.

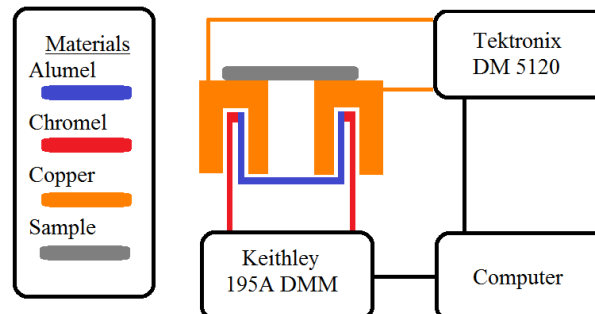

Figure 2.1: Block diagram of experimental setup.

## **2.2 Cleaning and assembling the Seebeck device**

The apparatus was cleaned of oxidation on a weekly basis. The blocks were first detached from all connecting wires and removed from the container. Once separated, the teflon screws connecting the copper blocks to the base plate could be removed exposing the bottom ends of the thermocouples. Once the thermocouples, copper wires, and resistive heater were removed, the copper blocks could be sanded. 600 grit sandpaper was used to clean off all the oxidization from the copper blocks. Sand paper was placed on a flat granite plate to sand the sample surface in order to maintain a flat plane. A razor blade was used to scrape off any oxidization from the copper wires before reassembly.

After the blocks were cleaned and fresh gloves were put on, every piece of the apparatus was washed with acetone to remove the small pieces of copper leftover from sanding. The first step in reassembly was reattaching the resistive heater to the side of the hot block. All wires marked with red tape are attached to the hot block and all positive connections to multimeters were similarly marked. After the copper wires were connected, the sample cover was attached to hold the copper blocks at the desired separation. This step helps protect the differential thermocouple from excessive bending and allowed for adjustments to ensure nothing was bridging the gap between the blocks. The assembly was finished by attaching the insulating layer and base plate with teflon screws to the copper blocks.

## **2.3 Installing samples**

Bulk and wire samples were cleaned with 600 grit sandpaper and acetone before testing. This removes any oxidation on the surface that otherwise would add a new material to the

thermocouple skewing the results. After cleaning, the sample was placed evenly across the gap between the copper blocks and secured with a cover plate. Since it can be difficult to establish electrical contact with high resistivity materials, bulk and wire samples had the cover plate screws tightened to assist the connection.

Thin-film samples are placed in the system film side down in the same position as bulk samples. Since the cover plate can easily break the wafer if tightened too much the following procedure was used instead. Two of the four screws in diagonal positions were threaded till the cover was lying flat across the sample. The other two screws were threaded in a similar fashion followed by tightening all four screws just to the point of resistance. This prevents the wafer from breaking but may not ensure good contact between the sample and copper. If electrical contact between the sample and copper blocks was not established then pieces of indium foil was placed between the blocks and sample surfaces. Indium is a soft material with good connectivity that molds to the sample thus improving contact. Prior to its application its surface needs to be scraped with a knife to remove any oxidation. . If the insertion of Indium foil did not solve the problem, the screws on the cover plate were alternately loosened and tightened to shift the sample in order to improve the electrical contact.

## **2.4 Checking the samples' electrical contact**

After the sample was installed the electrical contact was checked using the Keithley 195A voltmeter that records the voltage across the two blocks. The goal was to have this voltage read between  $\pm 5 \mu\text{V}$  which would indicate good electrical contact between the sample and the copper blocks. If the voltage does not settle around zero, electrical contact has not been established and the sample needs to be adjusted as described in section 2.3.

## 3. MATERIALS

### 3.1 Alumel and Chromel

Alumel and chromel are thermoelectric standards used to check the validity of the Seebeck device. Alumel is an n-type magnetic alloy consisting mainly of nickel and small amounts of manganese, aluminum and silicon. Its magnetic properties make it easy to separate from chromel using a magnet. Chromel is a p-type alloy made of nickel and chromium. These two materials are commonly used in conjunction with each other to make a K-type thermocouple and is one of the most common thermocouples used. Wire samples of both materials were used to test the Seebeck system's calibration by placing them across the copper blocks.

### 3.2 ITO thin film ( $\text{In}_2\text{O}_3:\text{Sn}$ )

A thin film sample of indium-tin-oxide (ITO) was used to test the system's ability to measure materials in thin film form. ITO is a semiconductor with well-established characteristics that was measured in 162 nm thin film form. ITO can have properties of a weak metal or semiconductor depending on its oxygen content. The sample used for calibration was made in an oxygen rich environment giving it metallic properties.

### 3.3 N-type and P-type Silicon

N and p-type silicon samples were measured to test the Seebeck system's ability to distinguish between materials with different carrier types. Silicon is a semiconductor that is commonly used in both the scientific and industrial community. It can behave as an n or p-type semiconductor depending on the material it is doped with. Wafer samples of  $\langle 111 \rangle$  p-type silicon of thickness  $620\mu\text{m}$  and  $\langle 100 \rangle$  n-type of thickness  $650\mu\text{m}$  were measured.

### 3.4 Doped goldfieldite ( $\text{Cu}_{10-x}\text{Ag}_x\text{Zn}_2\text{Sb}_4\text{S}_{13}$ )

Materials with the same crystalline structure as  $\text{Cu}_{12}\text{Sb}_4\text{S}_{13}$ , shown in figure 4.1, are from a class of materials known as tetrahedrites. The tetrahedrite is doped during e-beam deposition onto a silicon wafer to produce a 360nm sample of  $\text{Cu}_{10-x}\text{Ag}_x\text{Zn}_2\text{Sb}_4\text{S}_{13}$  known as doped goldfieldite where silver and zinc atoms have replaced copper atoms in the lattice. Samples with either one or three silver atoms were tested. Large Seebeck coefficient values have been previously found for doped goldfieldite in bulk form indicating that it has a good potential to be used as a thermoelectric engine (Heo). This paper examines if thin film doped goldfieldite has the same potential.

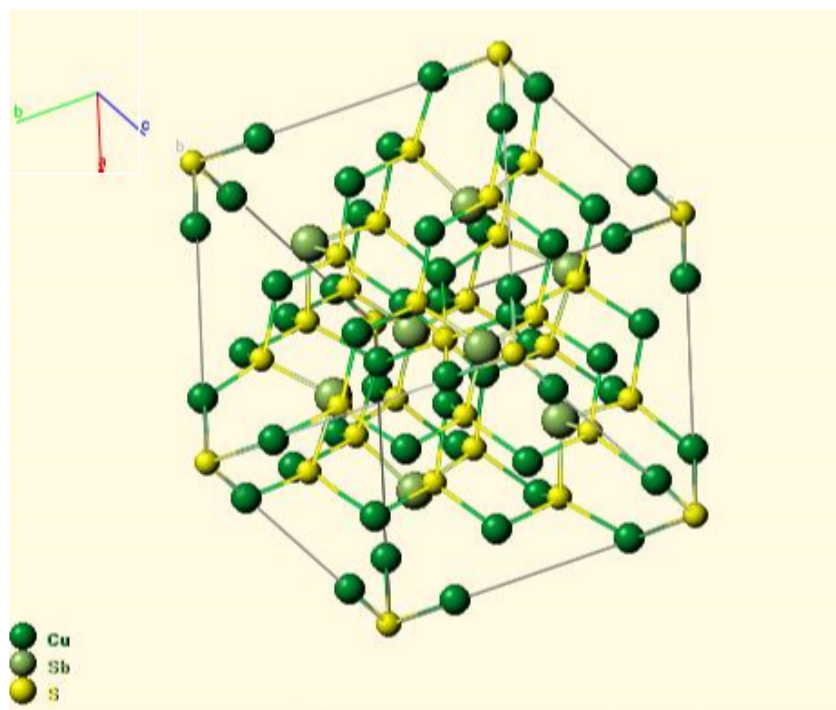

Figure 3.1: Unit cell for the crystalline structure of  $\text{Cu}_{12}\text{Sb}_4\text{S}_{13}$  (Johnson and Burnham).



## 4. EXPERIMENTAL RESULTS

### 4.1 Calibration with alumel and chromel

Wire samples of alumel and chromel were used to check the calibration of the Seebeck device. Figure 4.1 displays the results from the calibration tests for these two materials. When the sample voltage is plotted against the difference in temperature, the Seebeck coefficient can be estimated by the slope of the graph and Equation 3. The relative Seebeck coefficient was measured by the system to be  $-20.1$  and  $20.3 \mu\text{V/K}$ . The actual Seebeck coefficient for each material at room temperature was calculated by adding  $2.7 \mu\text{V/K}$  to adjust for the copper component of the relative Seebeck coefficient. The Seebeck coefficient for n-type Alumel and p-type Chromel was calculated at  $-18.3 \mu\text{V/K}$  and  $22.2 \mu\text{V/K}$  respectively. This agrees with the values of  $-18$  and  $22 \mu\text{V/K}$  found in the literature for these materials thus proving the validity of our system (Bentley, 1998).

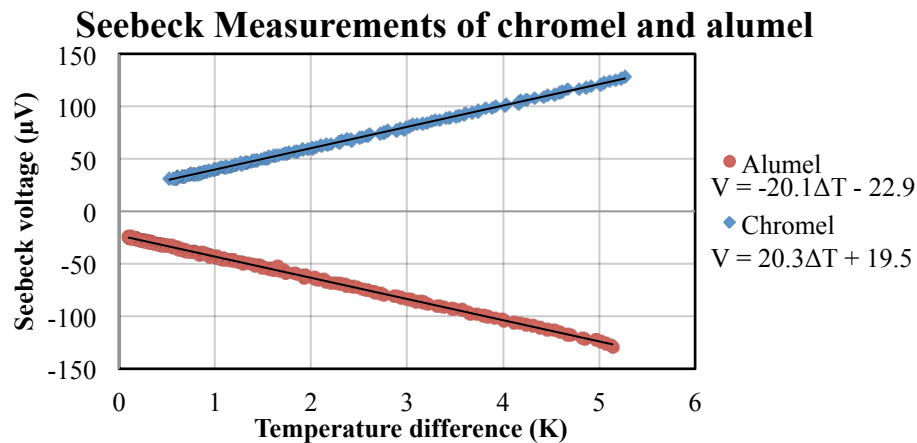

Figure 4.1: TV curves for Alumel and Chromel indicating Seebeck coefficients of  $-17.4$  and  $20.3 \mu\text{V/K}$  respectively.

## 4.2 Calibration with ITO thin film

The Seebeck value of ITO was measured to test the system's ability to work with thin films. ITO is highly conductive so electrical contact was established without the use of indium tabs. The curve shown in figure 4.2 shows the results from one trial for ITO. Equation 3 tells us that ITO has a Seebeck value of  $-9.4 \mu\text{V/K}$  ( $-12.1 \mu\text{V/K} + S_{\text{copper}}$ ). This result is comparable to the  $-17 \mu\text{V/K}$  found by Ray et al in ITO thin films of similar thickness (Ray, 1983).

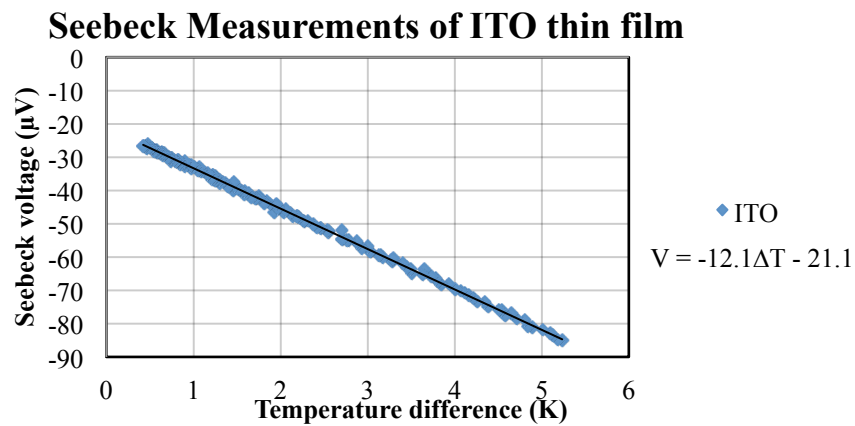

Figure 4.2: TV curve of ITO indicating a Seebeck coefficient of  $-9.4 \mu\text{V/K}$ .

## 4.3 N-type and P-type Silicon

Figure 4.3 shows the results for the Seebeck measurements of n and p-type silicon. P-type

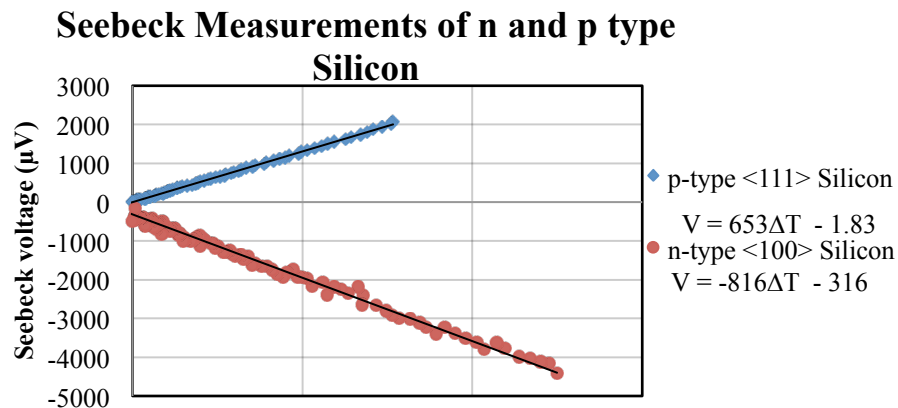

Figure 4.3: TV curve of n and p-type silicon with Seebeck coefficients of  $-816$  and  $653 \mu\text{V/K}$  respectively.

<111> silicon was found to have a coefficient of  $656 \mu\text{V/K}$  ( $653 \mu\text{V/K} + S_{\text{copper}}$ ) and n-type <100> silicon has a coefficient of  $-813 \mu\text{V/K}$  ( $-816 \mu\text{V/K} + S_{\text{copper}}$ ). The results confirm that the system is capable of measuring both n and p-type materials.

#### 4.4 Seebeck coefficient of doped goldfieldite ( $\text{Cu}_{10-x}\text{Ag}_x\text{Zn}_2\text{Sb}_4\text{S}_{13}$ )

Two variations of doped goldfieldite were tested in the Seebeck apparatus. The sample oct5b is the  $x = 1$  variant where on average one silver atom exists per unit cell. Oct5b was found to have a Seebeck coefficient of  $13.0 \mu\text{V/K}$  ( $10.3 \mu\text{V/K} + S_{\text{copper}}$ ). Oct7a is the variant with  $x = 3$  that resulted in a Seebeck coefficient of  $71.6 \mu\text{V/K}$  ( $68.9 \mu\text{V/K} + S_{\text{copper}}$ ). The carrier concentrations, denoted as  $\sigma$ , of thin film doped goldfieldite were previously measured in the Tate laboratory by Rodney Snyder (Snyder, 2014). Combining Snyder's data and the Seebeck coefficients determined in this project allowed the calculation of the power factor. That data is summarized in table 5.2 of the discussion section.

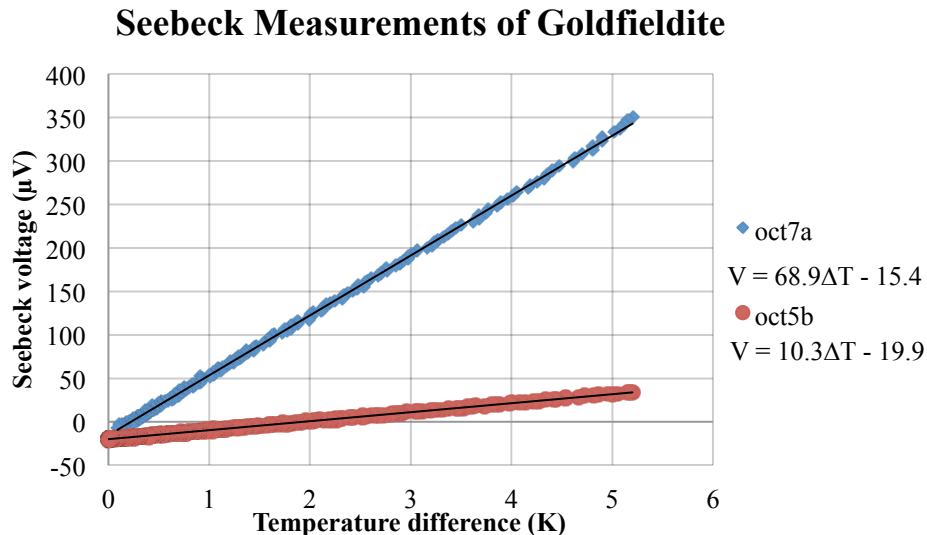

Figure 4.4: TV curves of doped goldfieldite samples with Seebeck coefficients of  $71.6$  and  $13.0 \mu\text{V/K}$ .

<b>Material</b>	<b>Measured Seebeck Coefficient (<math>\mu\text{V/K}</math>)</b>
Alumel	-18.3
Chromel	22.2
ITO	-9.4
N-type silicon	-813
P-type silicon	656
Doped goldfieldite oct5b	13.0
Doped goldfieldite oct7a	71.6

**Table 4.1: Results for Seebeck measurements of all materials tested.**

## 5. DISCUSSION

The objective of this project was to investigate the material properties of doped goldfieldite in thin film form to test its potential success as a thermoelectric engine. Bulk samples of doped goldfieldite had shown high Seebeck values and indicated potential success prompting further investigation (Heo). The results from our investigation are summarized in table 5.1, where variant  $x$  stands for the number of silver atoms replacing copper atoms. The resistivity measurements came from Rodney Snyder's research and the Seebeck coefficient is the results of my research. By combining these two measurements in Equation 4 we get an estimation for the power factor of doped goldfieldite.

Variant # ( $x$ )	Resistivity ( $m\Omega\text{ cm}$ ) (Snyder)	Measured Seebeck Coefficient ( $\mu\text{V/K}$ )	Power Factor ( $\text{W}/\text{mK}^2$ )
1	50.8	13.0	$2.0 \cdot 10^{-7}$
3	8.4	71.6	$5.4 \cdot 10^{-5}$

Table 5.1: Thermal transport properties of doped goldfieldite.

The power factors for  $\text{Cu}_{10-x}\text{Ag}_x\text{Zn}_2\text{Sb}_4\text{S}_{13}$  for  $x = 1$  and  $x = 3$  in thin film form are in the range  $10^{-7}$  to  $10^{-5}$ . These values are dramatically lower than expected from the bulk measurements of the Seebeck coefficient performed by Jaeseok Heo. This paper showed that doped goldfieldite in thin film form loses the high Seebeck coefficients of bulk doped goldfieldite. These low Seebeck coefficients of doped goldfieldite in thin film form prevent  $ZT$  values from being greater than  $ZT > 1$ . An efficient thermoelectric engine would be reflected in a  $ZT$  value greater than 1. In order to bring  $ZT$  close to 1, a  $\kappa$  value in the range of  $10^{-3}\text{ W}/(\text{mK})$  would be needed. The smallest thermal conductivity ever recorded was  $0.06\text{ W}/(\text{mK})$  for a sample of  $\text{WSe}_2$  suggesting that it would be unrealistic for doped goldfieldite to have a  $\kappa$  value low enough to get a power factor larger than 1 (Chiritescu).

## Bibliography

- Bentley, Robin E. *Theory and Practice of Thermoelectric Thermometry Vol. 3*. Singapore: Springer-Verlag, 1998.
- Chiritescu, Catalin, David G. Cahill, Ngoc Nguyen, David Johnson, Arun Bopapati, Pawel Keblinski, and Paul Zschack. "Ultralow Thermal Conductivity in Disordered, Layered WSe<sub>2</sub> Crystals." *Science*. Vol 315, 351-353. (2007)
- Easley, Dara L. "Room Temperature Seebeck Measurements on CuSc<sub>1-x</sub>Mg<sub>x</sub>O<sub>2+y</sub> Transparent Conductive Thin Films." Oregon State University Honors College senior thesis (2003).
- Heo, Jaeseok, Ram Ravichandran, Christopher F. Reidy, Janet Tate, John F. Wager, and Douglas A. Keszler. "Design Meets Nature: Tetrahedrite Solar Absorbers." *Advanced Energy Materials Adv. Energy Mater.* 5.7, 2047-2051, (2014).
- Johnson, M L and C W Burnham. "Crystal structure refinement of an arsenic-bearing argentine tetrahedrite." *American Mineralogist*. Vol 70, 165-170, (1985).
- Kasap, Safa. *Thermoelectric Effects in Metals: Thermocouples*. Saskatchewan, 2001. e-book <http://materials.usask.ca/samples/Thermoelectric-Seebeck.pdf>.
- Ray, Swati, Ratnabali Banerjee, N. Basu, A. K. Batabyal, and A. K. Barua. "Properties of Tin Doped Indium Oxide Thin Films Prepared by Magnetron Sputtering." *Journal of Applied Physics* 54.6, 3497, (1983)
- Seebeck, T. J. *Ueber die Magnetische Polarisation der Metalle und Erzedurch Temperature-Differenz*. Vol. 82. Leipzig: Willhelm Engalman, 1822.
- Snyder, Rodney. "Thermoelectric Characterization of Silicon Wafers and Cu<sub>12</sub>Sb<sub>4</sub>S<sub>13</sub> Variant Thin Films." Oregon State University Honors College senior thesis (2014). <http://hdl.handle.net/1957/52139>

